

INTRO
HELLO

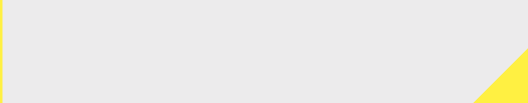

BOLD VISION
NEW OPEN

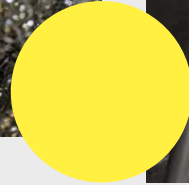

LIGHT FORMS LIFE

Światło odgrywa kluczową rolę w każdym wnętrzu. To ono wskazuje drogę po zmroku, potrafi wprowadzić przytulny nastrój albo pobudzić do działania i zwiększyć koncentrację. Dlatego już od ponad 30 lat oświetlenie jest naszą pasją i źródłem nieustannej inspiracji. W Centrum Badawczo-Rozwojowym w Czernichowie pod Krakowem zespół doświadczonych specjalistów opracowuje, testuje i udoskonala oprawy oświetleniowe. Każdy projekt to połączenie funkcjonalności, nowoczesnej technologii i wyjątkowego designu. Nasze rozwiązania nie tylko zachwycają formą, lecz także wpływają na samopoczucie i atmosferę we wnętrzu. Odkryj z nami, jak światło może odmienić Twoją przestrzeń!

Light plays a key role in every interior. It guides the way after dark, can create a welcoming atmosphere, or stimulate activity and focus. That is why, for over 30 years, lighting has been our passion and a constant source of inspiration. At our Research and Development Centre in Czernichów near Kraków, a team of experienced specialists develops, tests, and refines lighting fixtures. Every project combines functionality, advanced technology, and distinctive design. Our solutions impress not only through form but also through their impact on wellbeing and the atmosphere of interior spaces. Discover with us how light can transform your space!

NO
NONSENSE
DESIGN

BUCLÓ in LED suspended

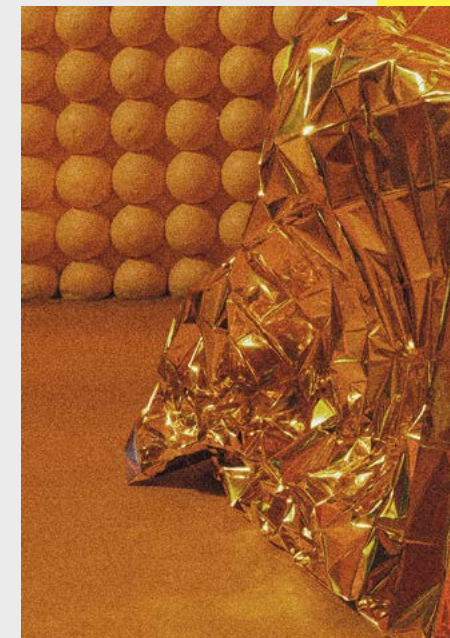
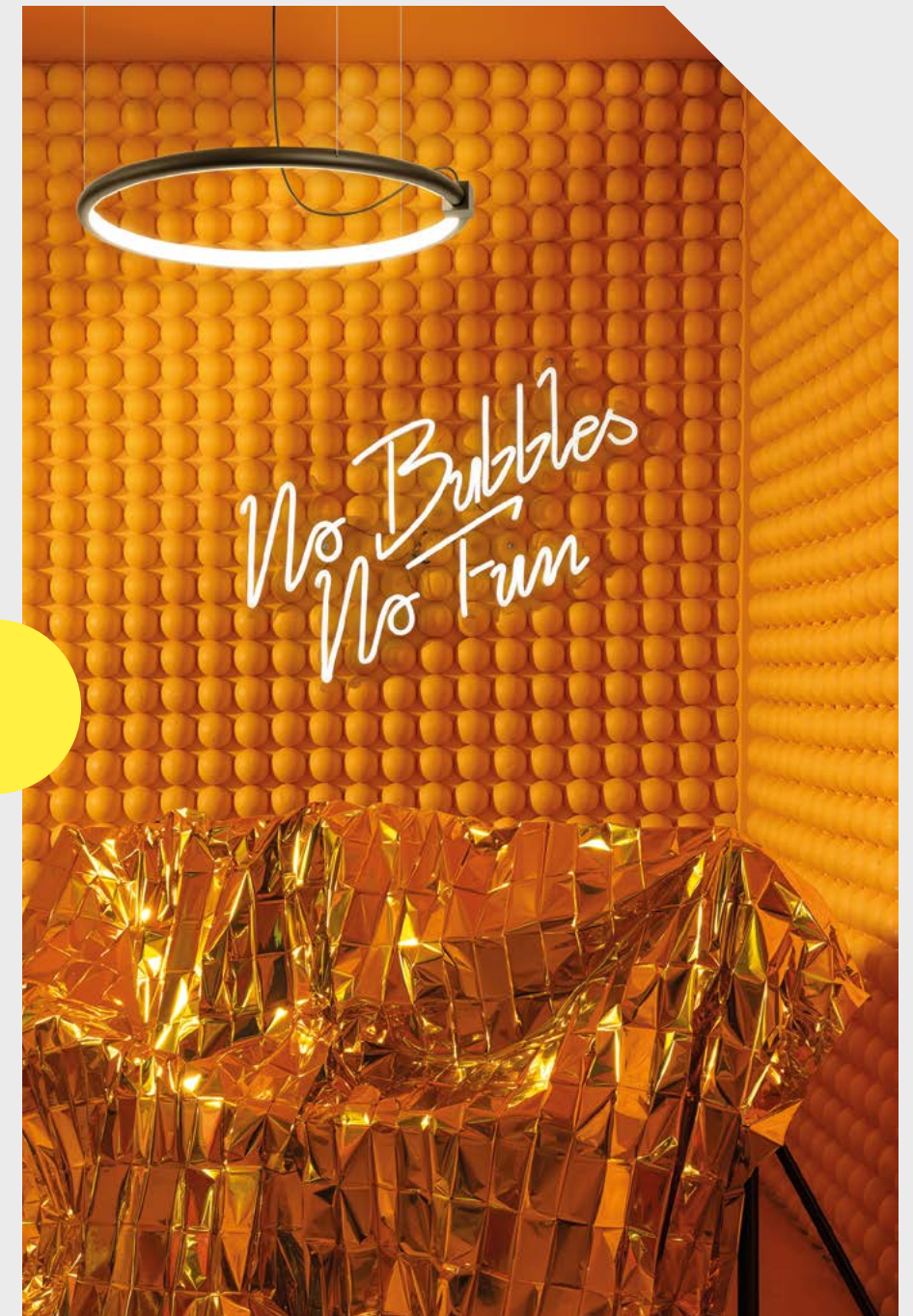

CONTENTS

W ofercie AQForm znajdziesz rozwiązania stworzone z myślą o każdym wnętrzu – od przytulnych mieszkań po nowoczesne przestrzenie biurowe. Nasze oprawy łączą wyjątkowy design z najwyższą jakością wykonania, oferując perfekcyjne połączenie estetyki i funkcjonalności.

In AQForm's offer, you will find solutions designed for every interior – from welcoming apartments to modern office spaces. Our luminaires combine distinctive design with high-quality craftsmanship, offering a balanced combination of aesthetics and functionality.

RECESSED	— 054
SURFACE	— 124
SUSPENDED	— 228
TRACK	— 342
WALL	— 452
FLOOR, TABLE, PORTABLE	— 504
EXTERIOR	— 522
SYSTEMS	— 562
INDEX by name	— 630

RIBBY line up&down LED suspended

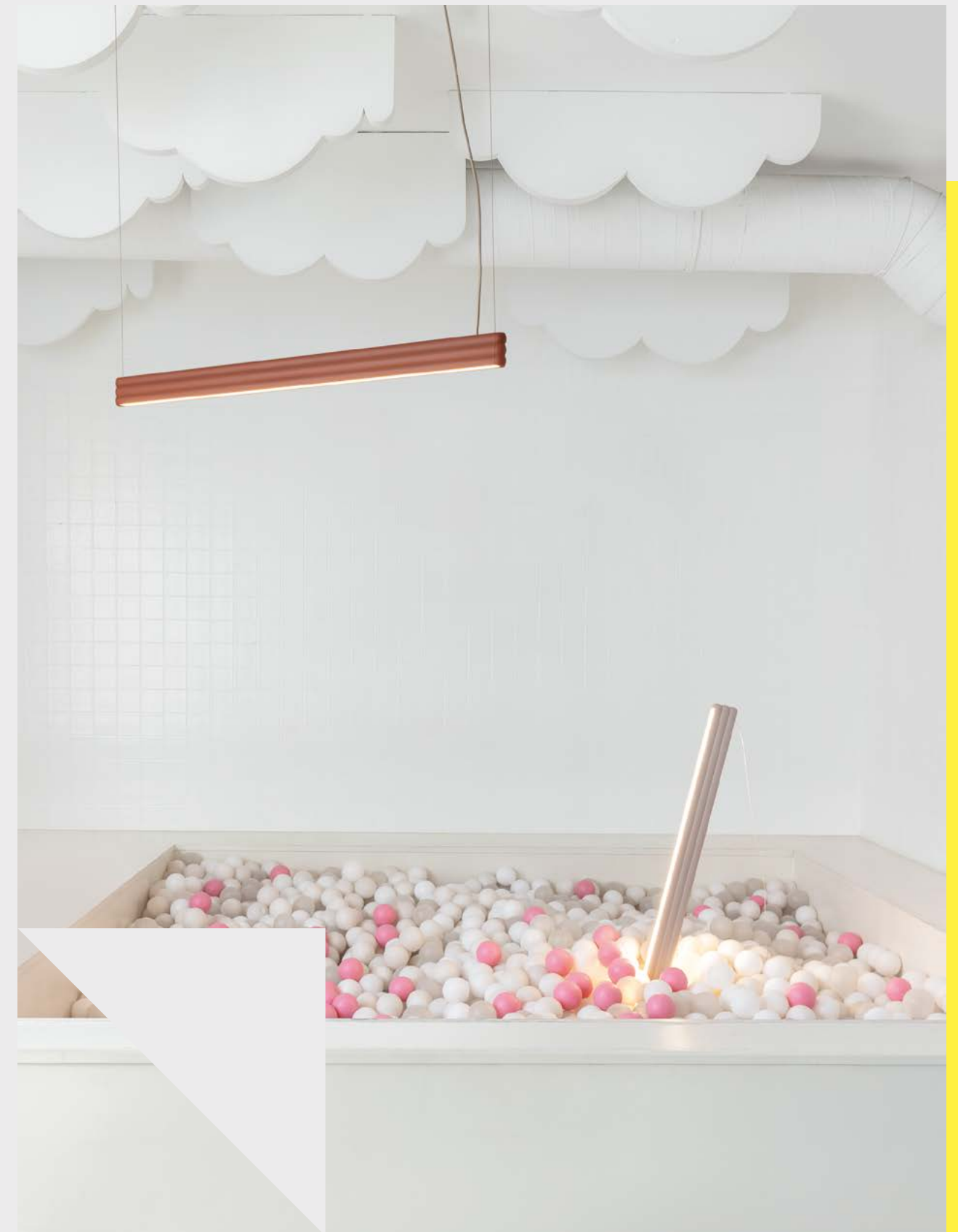

AQFORM

LIGHTING SOLUTIONS

OUR STORY



Did you know our story dates back to 1992, when we started out with... furniture production? Much has changed since then, but one thing remains unchanged – our passion for top-quality products. Before you explore the next pages of our catalogue, filled with modern lighting solutions and inspiration, let us share a few interesting facts about our brand!

Czy wiesz, że nasza historia sięga 1992 roku, kiedy zaczęliśmy od... produkcji mebli? Od tamtej pory wiele się zmieniło, ale jedno pozostało niezmiennie – nasza pasja do najwyższej jakości produktów. Zanim odkryjesz kolejne strony katalogu, pełne nowoczesnych rozwiązań oświetleniowych i inspiracji, pozwól nam podzielić się kilkoma fascynującymi faktami o naszej marce!



OUR STORY LABS & production

Marka AQForm to przede wszystkim Centrum Badawczo-Rozwojowe i fabryka ulokowane w Polsce, w miejscowości Czernichów nieopodal Krakowa, zajmująca powierzchnię aż 11 000m². Dzięki temu mamy gwarancję, jak świecą nasze oprawy, a przede wszystkim dostarczamy niezawodne produkty, zapewniające światło najwyższej jakości. Serce naszych badań nad oprawami oświetleniowymi stanowią laboratoria. To tu wykwalifikowany zespół specjalistów codziennie testuje produkty pod kątem bezpieczeństwa, trwałości i funkcjonalności, a dzięki rygorystycznym procedurom możemy dostarczać sprawdzone i skuteczne rozwiązania.

AQForm is, above all, a Research and Development Centre and manufacturing facility located in Poland, in Czernichów near Kraków, covering a total area of 11,000m². This ensures we understand how our luminaires perform and, above all, deliver reliable products that provide light of the highest quality. At the heart of our lighting research are our laboratories. Here, a qualified team of specialists tests products daily for safety, durability, and functionality. Thanks to rigorous procedures, we can deliver proven and dependable solutions.



INTRO

SUSTAINABILITY



MROOM LED table

AQForm konsekwentnie realizuje działania proekologiczne, traktując zrównoważony rozwój jako ważny element strategii firmy. W naszej codziennej działalności stosujemy ekologiczne opakowania, ograniczając dzięki temu plastik i wybierając materiały nadające się do recyklingu. Również nowa hala produkcyjna została zaprojektowana z myślą o środowisku – na jej dachu znajduje się zieleń, która wspiera retencję wody, poprawia mikroklimat i ogranicza nagrzewanie budynku. Dodatkowo korzystamy z paneli fotowoltaicznych, dzięki którym część energii pochodzi ze źródeł odnawialnych. W AQForm dbamy o odpowiedzialną produkcję, efektywne procesy i długą żywotność naszych produktów, wierząc, że nowoczesny design może iść w parze z troską o środowisko. Własna produkcja ulokowana w Polsce pozwala nam także znacząco ograniczyć ślad węglowy.



AQForm consistently pursues environmentally responsible initiatives, treating sustainability as an important element of the company's strategy. In our daily operations, we use eco-friendly packaging, reducing plastic and selecting recyclable materials. Our new production hall was also designed with environment considerations in mind. Its roof features greenery that supports water retention, improves the microclimate, and limits heat build-up. Additionally, we use photovoltaic panels, allowing part of our energy to come from renewable sources. At AQForm, we focus on responsible production, efficient processes, and long product lifecycles, believing that modern design can go hand in hand with care for the environment. In-house manufacturing based in Poland also allows us to significantly reduce our carbon footprint.

AWARD-WINNING PERFORMANCE

Oprawy AQForm to połączenie nowoczesnego designu, innowacji i jakości. Docenili to jurorzy wielu polskich i zagranicznych konkursów, takich jak m.in. German Design Award, iF, Red Dot, Dobry Wzór czy must have.



Kliva



Cona



AQForm luminaires combine modern design, innovation, and quality. This has been recognised by the juries of numerous Polish and international competitions, including the German Design Award, iF, Red Dot, Dobry Wzór, and Must Have.

Triba



www.aqform.com

Ribby



reddot winner 2025



Qrled next



CREATED FOR YOU

Bliska współpraca z projektantami to kluczowy etap w tworzeniu naszych produktów. Dzięki niej powstają oprawy, które zachwycają wyglądem, a jednocześnie są wyjątkowo praktyczne. Takie połączenie sprawia, że stają się one stylową ozdobą wnętrza, dostarczając przy tym najwyższej jakości światło. To najlepszy dowód na to, że innowacyjna technologia i przemyślany design mogą stworzyć perfekcyjny duet.



Piotr Jagiełłowicz



Andrzej Klisz

Close collaboration with designers is a key stage in creating our products. As a result, we develop luminaires impress with their appearance while remaining highly practical. This combination allows them to become a distinctive feature of an interior while delivering light of the highest quality. It demonstrates that innovative technology and thoughtful design can create the perfect duo.



Maciej Ferenc

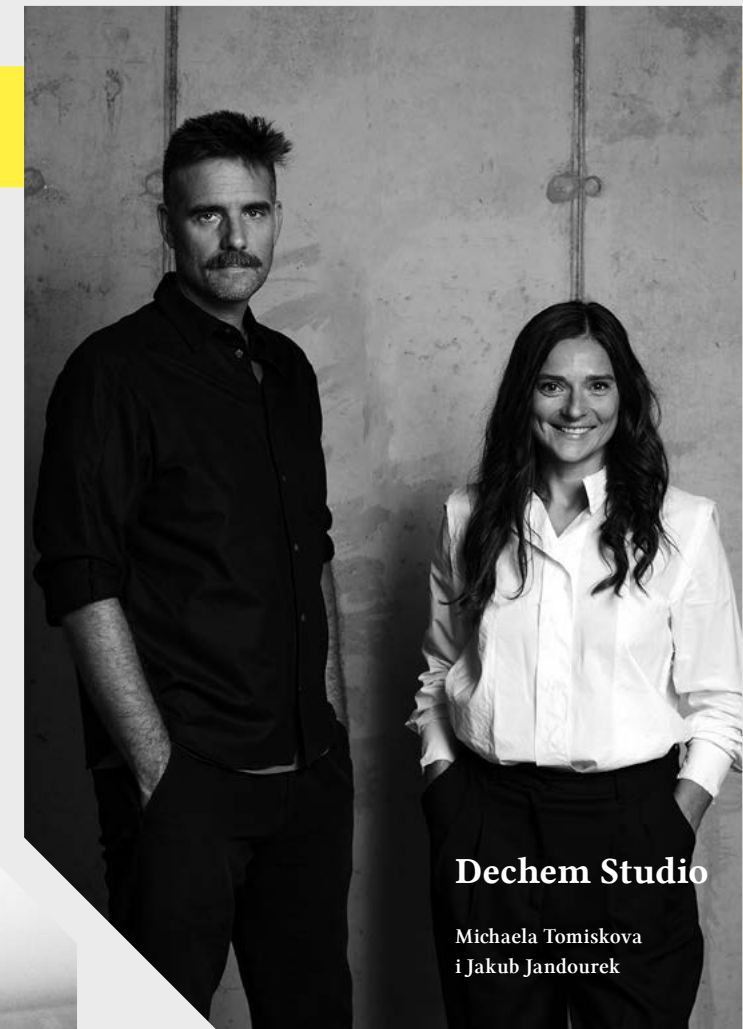

Dechem Studio

Michaela Tomiskova
i Jakub Jandourek

TAILORED TO YOUR NEEDS

W naszej standardowej ofercie znajdziesz szeroki przekrój opraw oświetleniowych, które odpowiadają na rozmaite potrzeby wnętrz prywatnych i komercyjnych. Portfolio zawiera produkty o zróżnicowanej formie i parametrach technicznych, co pozwala na precyzyjne dopasowanie oświetlenia do funkcji, charakteru oraz estetyki konkretnej przestrzeni.

Oferta niestandardowa pozwala na precyzyjne dopasowanie opraw oświetleniowych do indywidualnych założeń projektu. Na życzenie możliwa jest modyfikacja parametrów technicznych, formy oraz detali wykończenia, w tym również koloru. Dzięki temu nasze oświetlenie stanowi jasną odpowiedź na konkretne potrzeby wnętrz prywatnych i publicznych, dostosowując się do nich w niezwykle elastyczny sposób.



In our standard offer, you will find a wide range of lighting fixtures designed to meet the diverse needs of residential and commercial interiors. The portfolio includes products of diverse form and technical parameters, allowing lighting to be precisely matched to the function, character, and aesthetics of any given space.

Our custom offer allows lighting fixtures to be precisely adapted to the specific requirements of a project. Upon request, technical parameters, shapes, and finishing details, including colour, can be modified. As a result, our lighting solutions provide a clear response to the unique needs of private and public interiors, adapting to them in a highly flexible manner.



WE'RE FAMILY



Hollow

Kolekcja HOLLOW to jedna z najbardziej rozbudowanych serii oświetleniowych naszej marki. Bogactwo modeli, rozmiarów i wykończeń sprawia, że doskonale wpisuje się w potrzeby różnorodnych przestrzeni – od mieszkań i biur, po restauracje i hotele, oferując spójne, eleganckie i funkcjonalne oświetlenie.

The HOLLOW collection is one of the most extensive lighting series in our brand's portfolio. Its wide range of models, sizes and finishes makes it a perfect fit for diverse spaces – from apartments and offices to restaurants and hotels – delivering cohesive, elegant, and functional lighting.

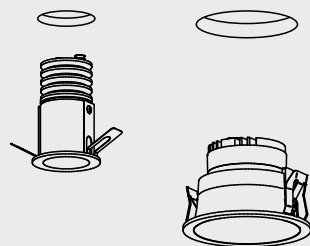
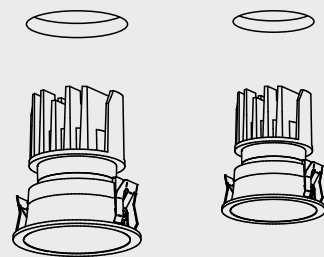

RECESSED 078

WE'RE FAMILY



Pet

Rodzina opraw PET to funkcjonalna seria oświetleniowa, obejmująca szeroki wybór modeli – od minimalistycznych spotów po efektowne tuby. Dostępna w wielu rozmiarach, mocach i wykończeniach, doskonale sprawdza się w różnych przestrzeniach – od nowoczesnych mieszkań, przez biura, po hotele i eleganckie lokale użytkowe.

The PET family is a functional lighting series comprising of a wide selection of models – from minimalist spots to striking tubes. Available in various sizes, wattages and finishes, it performs effectively across different spaces – from modern apartments and offices to hotels and elegant commercial interiors.

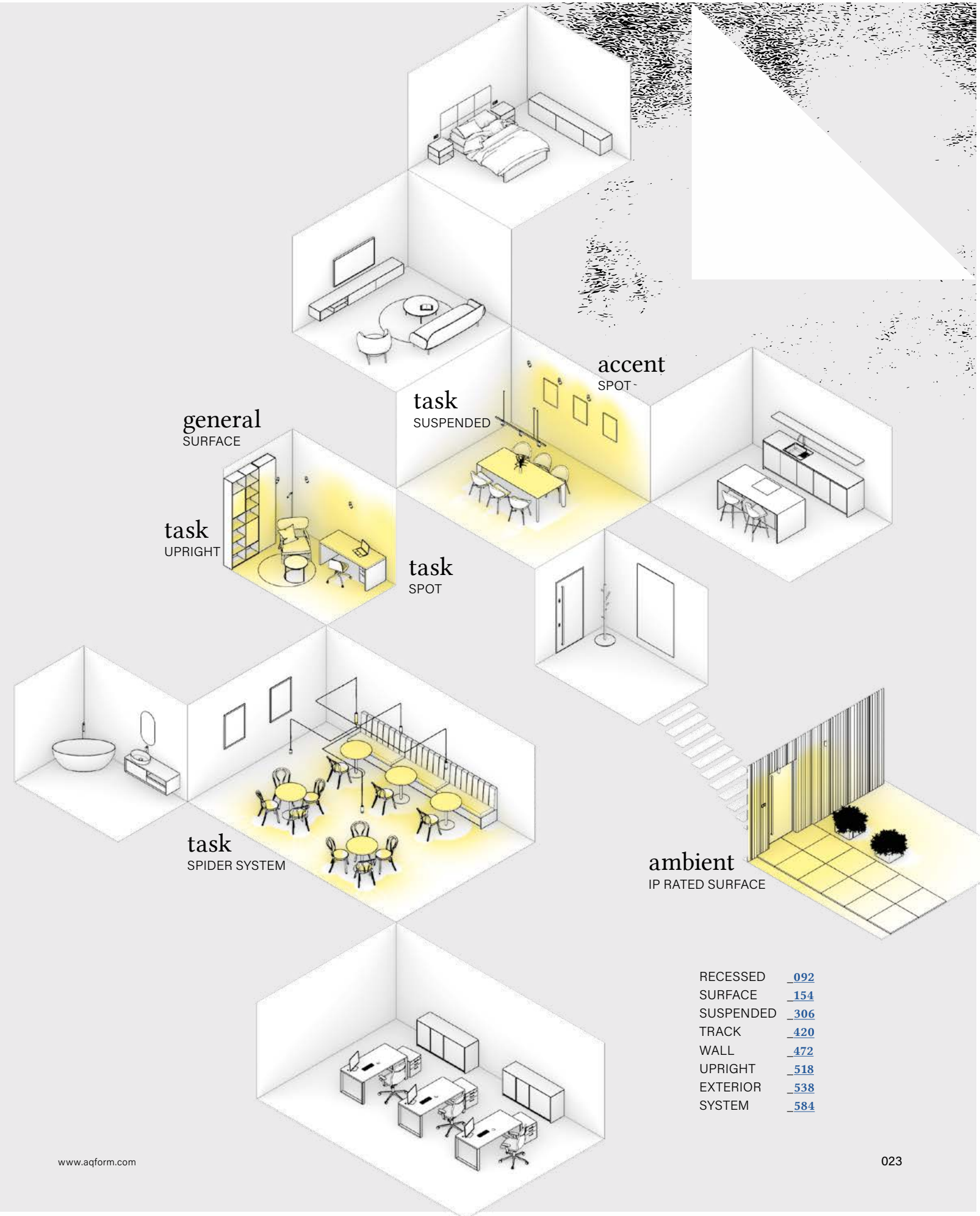
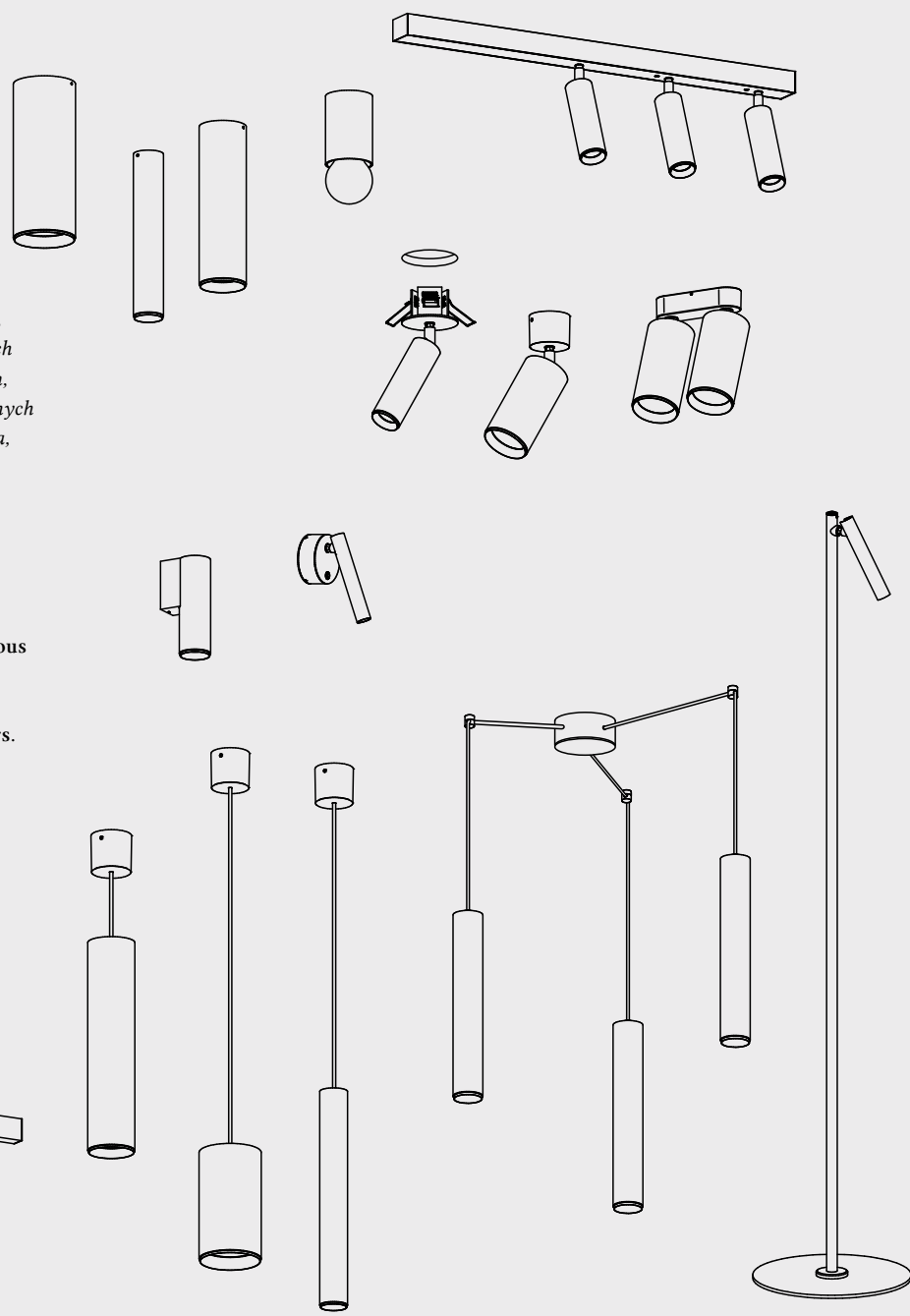

RECESSED	<u>092</u>
SURFACE	<u>154</u>
SUSPENDED	<u>306</u>
TRACK	<u>420</u>
WALL	<u>472</u>
UPRIGHT	<u>518</u>
EXTERIOR	<u>538</u>
SYSTEM	<u>584</u>

WE'RE FAMILY

Triba

Kolekcja TRIBA to wszechstronna linia opraw, łącząca elegancki design z funkcjonalnością. Szeroki wybór modeli, rozmiarów i wykończeń sprawia, że idealnie dopasowuje się do każdego projektu – od domowych wnętrz po przestrzenie biurowe, hotelowe i restauracyjne, pełniąc rolę skutecznego oświetlenia zadaniowego lub nastrojowego światła dekoracyjnego.

The TRIBA collection is a versatile range of luminaires combining elegant design with functionality. Its wide selection of models, sizes and finishes allows it to be adapted to a wide range of projects – from residential interiors to office, hotel, and restaurant spaces – serving as effective task lighting or atmospheric decorative illumination.

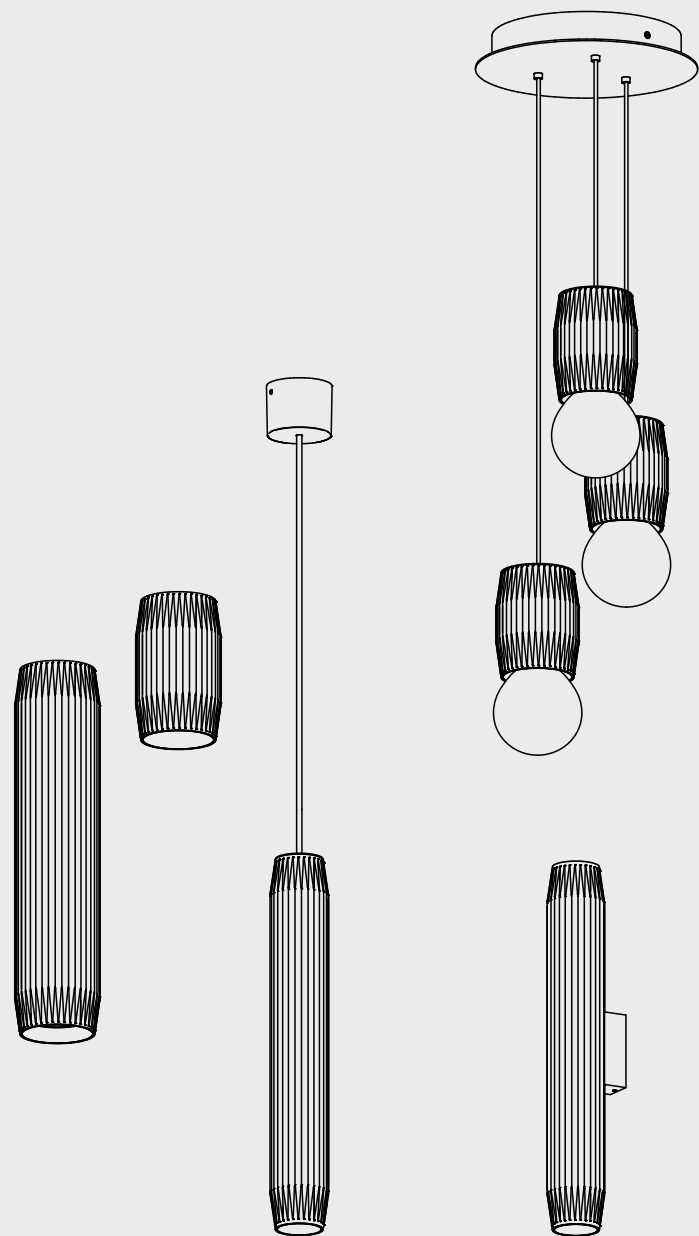
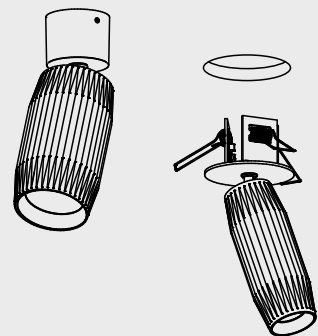

RECESSED	090
SURFACE	148
SUSPENDED	282
TRACK	412
WALL	470
SYSTEM	587

WE'RE FAMILY

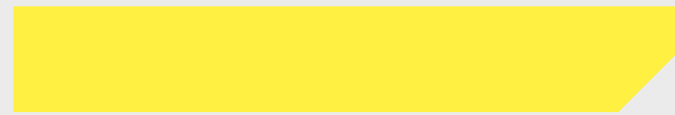

Qrled next

QRLED NEXT to wszechstronna i rozbudowana kolekcja oświetleniowa, oferująca szeroki wybór modeli i konfiguracji. Dzięki różnorodności rozmiarów, kształtów i wykończeń sprawdza się w wielu przestrzeniach – od mieszkań i biur, po hotele i lokale usługowe, zapewniając nowoczesne, funkcjonalne i eleganckie światło.

QRLED NEXT is a versatile and extensive lighting collection offering a wide range of models and configurations. With a variety of sizes, shapes, and finishes, it performs well across numerous spaces – from apartments and offices to hotels and service interiors – delivering modern, functional, and elegant illumination.

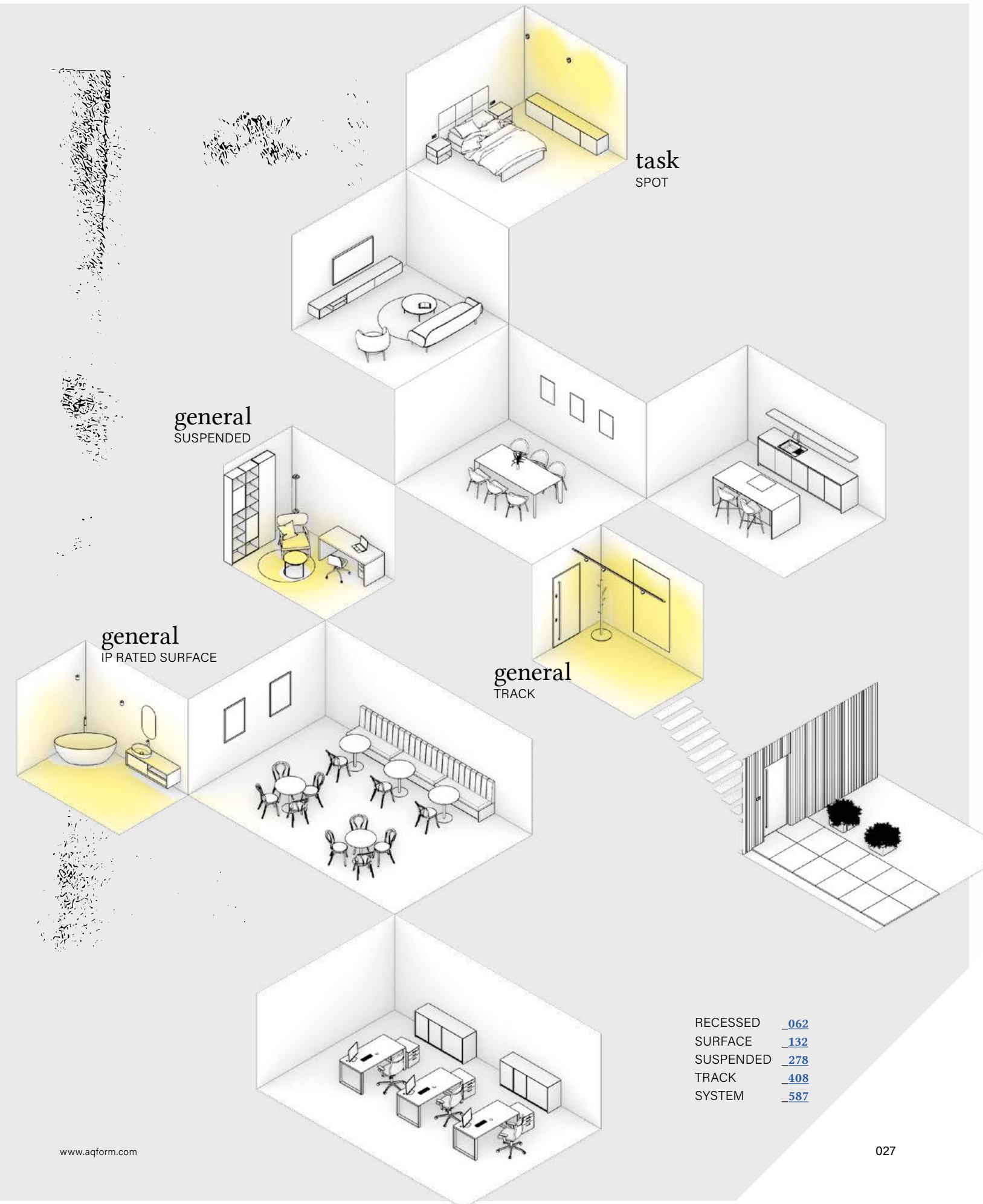
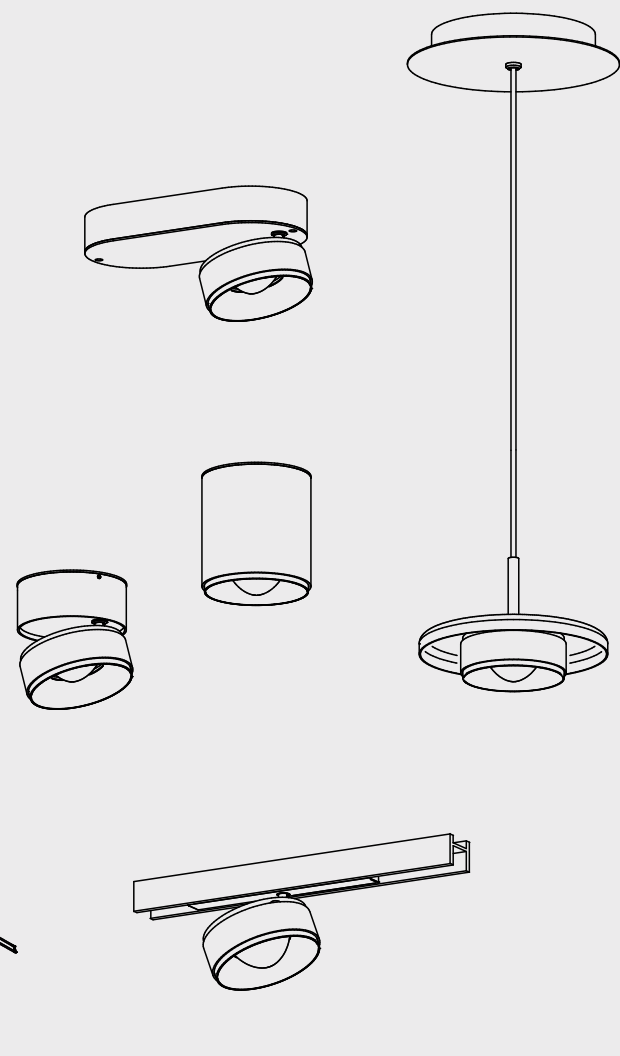

task SPOT

general SUSPENDED

general IP RATED SURFACE

general TRACK

RECESSED	<u>062</u>
SURFACE	<u>132</u>
SUSPENDED	<u>278</u>
TRACK	<u>408</u>
SYSTEM	<u>587</u>

WE'RE FAMILY

Ribby

Kolekcja RIBBY to propozycja dla tych, którzy cenią odważny design i chcą wyróżnić swoje wnętrza. Inspirowana stylem Memphis, zachwyca miękkimi liniami i niebanalną formą. RIBBY doskonale komponuje się z przestrzeniami pełnymi charakteru, które nie boją się odejść od utartych schematów.

The RIBBY collection is intended for those who value bold design and wish to give their interiors a distinctive character. Inspired by the Memphis style, it features soft lines and an unconventional form. RIBBY integrates naturally with spaces full of character, unafraid to move beyond established patterns.

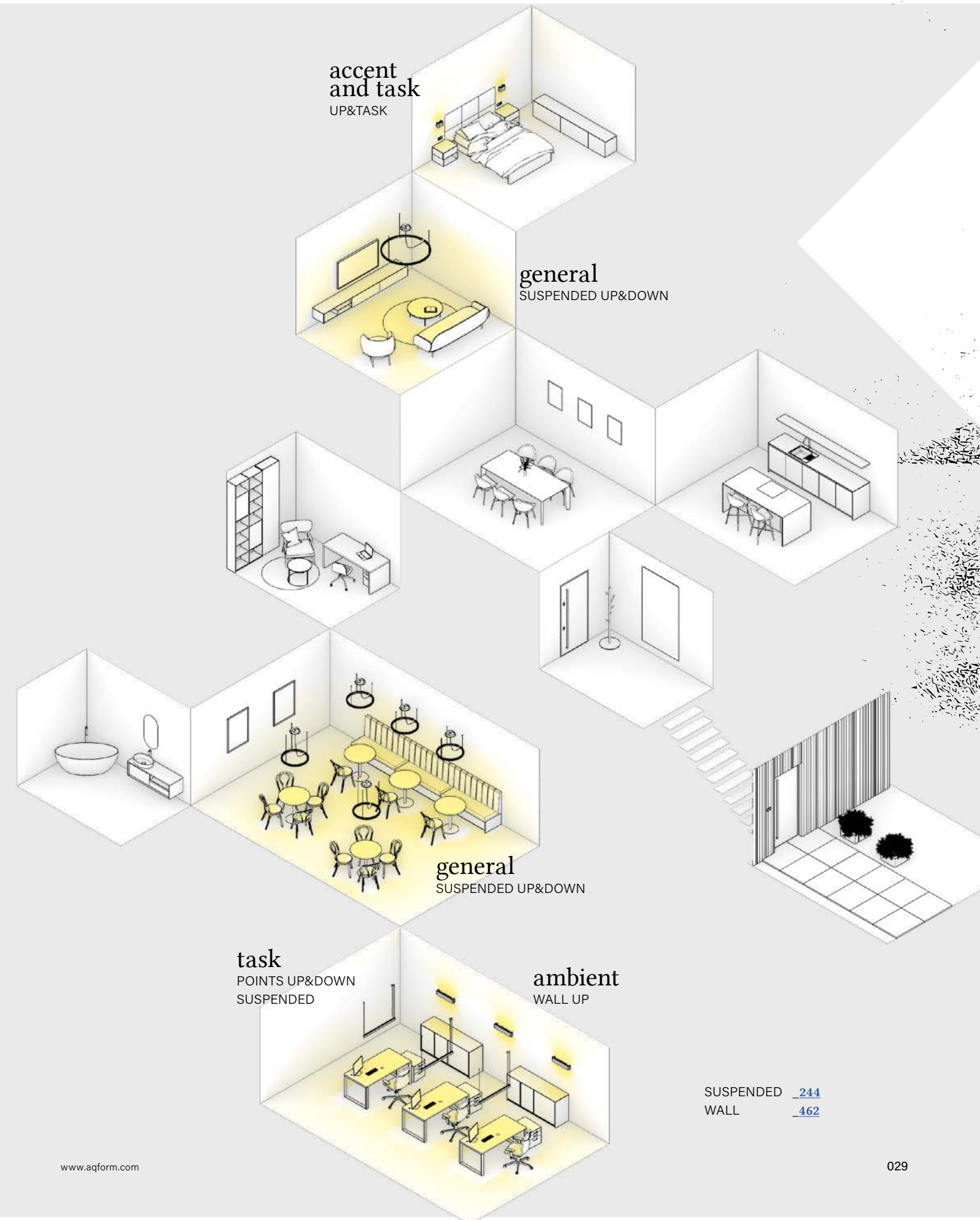
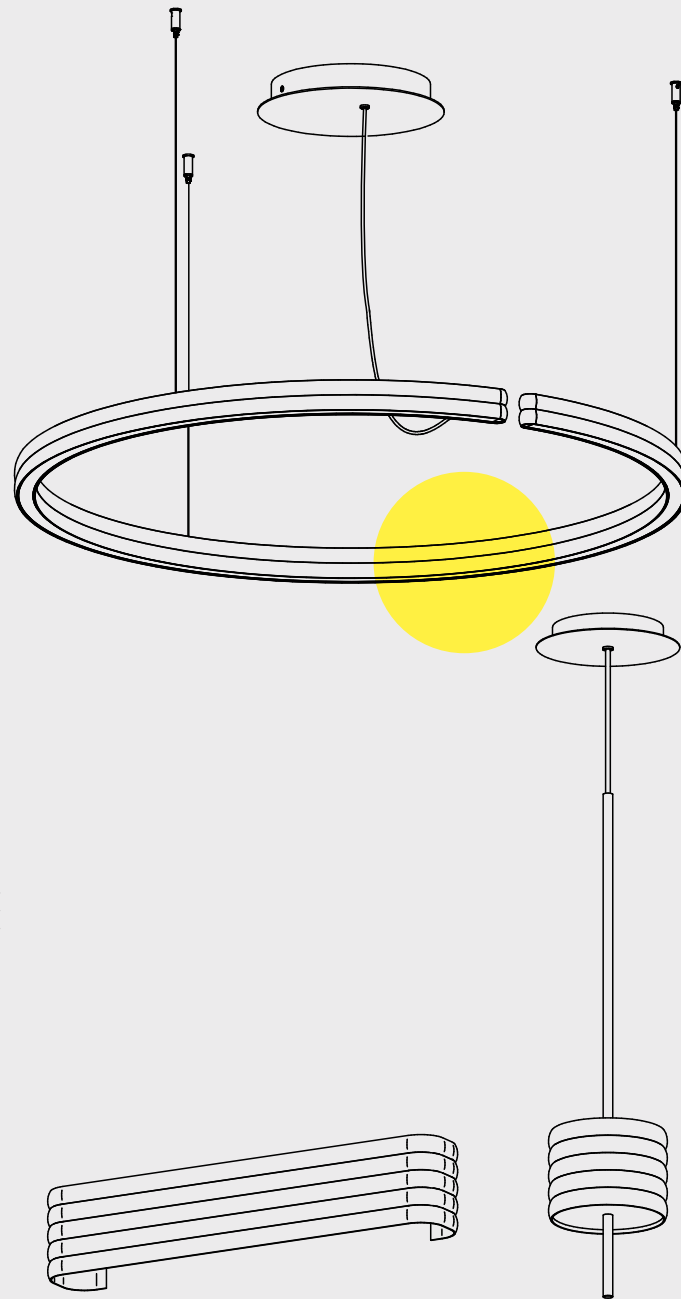

SUSPENDED [244](#)
WALL [462](#)

LET'S PLAY



Odkryj naszą różnorodną ofertę oświetleniową – od nowoczesnych opraw dekoracyjnych po funkcjonalne rozwiązania architektoniczne. W nowym katalogu znajdziesz produkty skrojone na miarę nawet najbardziej wymagających wnętrz.

Discover our diverse lighting range – from modern decorative luminaires to functional architectural solutions. In our new catalogue, you will find products tailored to meet the needs of even the most demanding interiors.

CASE STUDY



RESIDENTIAL

Nasze oprawy doskonale sprawdzają się w przestrzeniach prywatnych, podkreślając ich wyjątkowy charakter. Wydobywają z aranżacji to, co najpiękniejsze, tworzą przyjemny nastrój, a przede wszystkim zapewniając oświetlenie najwyższej jakości.

Our luminaires perform effectively in private spaces, highlighting their unique character. They bring out the beauty of interior arrangement, create a pleasant atmosphere, and, above all, provide lighting of the highest quality.

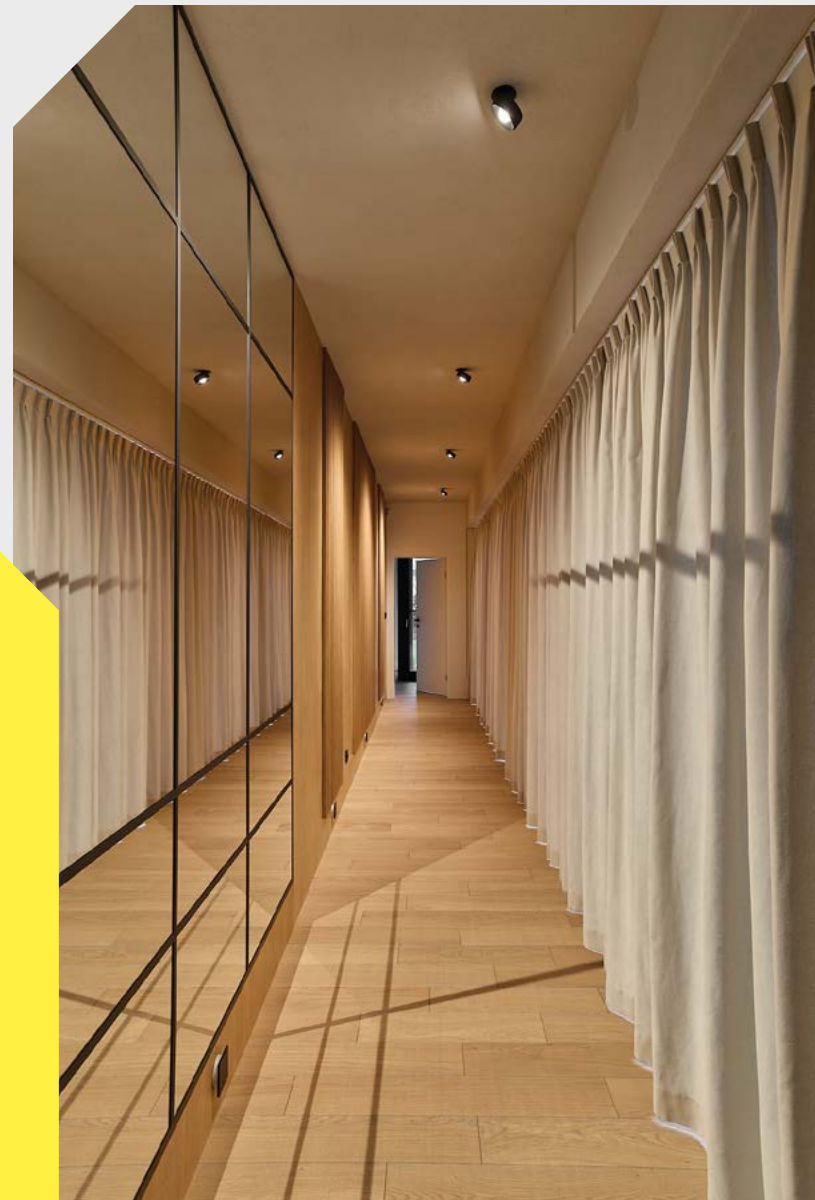

PET mini LED surface

Château de Sancerre, Sancerre



HOSPITALITY

Nasza oferta dla gastronomii i hotelarstwa łączy nowoczesne oświetlenie z funkcjonalnością. Tworzymy rozwiązania, które podkreślają charakter wnętrza, budują atmosferę i zachwycają designem.

Our offer for the hospitality and restaurant sector combines modern lighting with functionality. We create solutions that highlight the character of an interior, create atmosphere and impress through design.

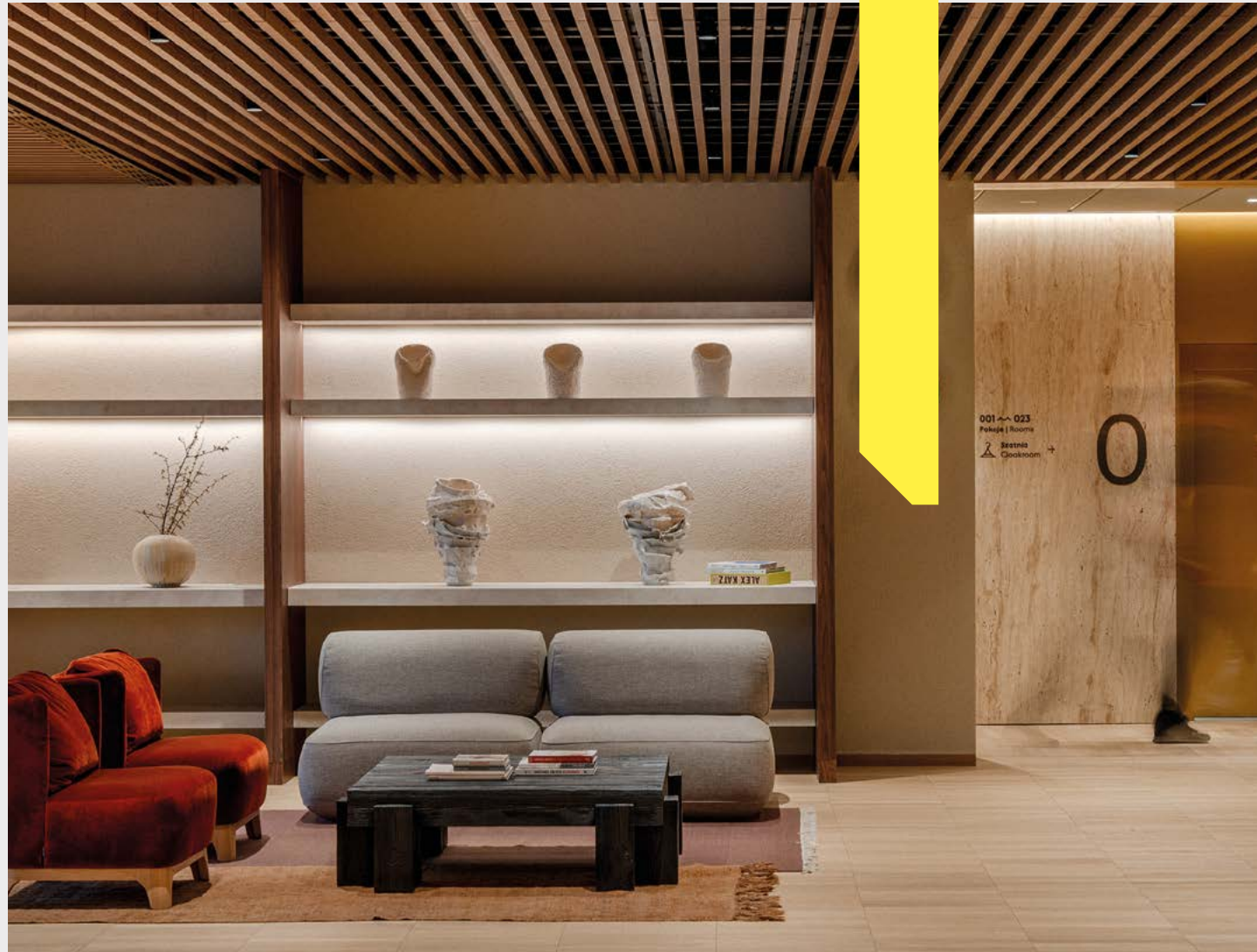

Hotel Glar

PET midi rift LED surface

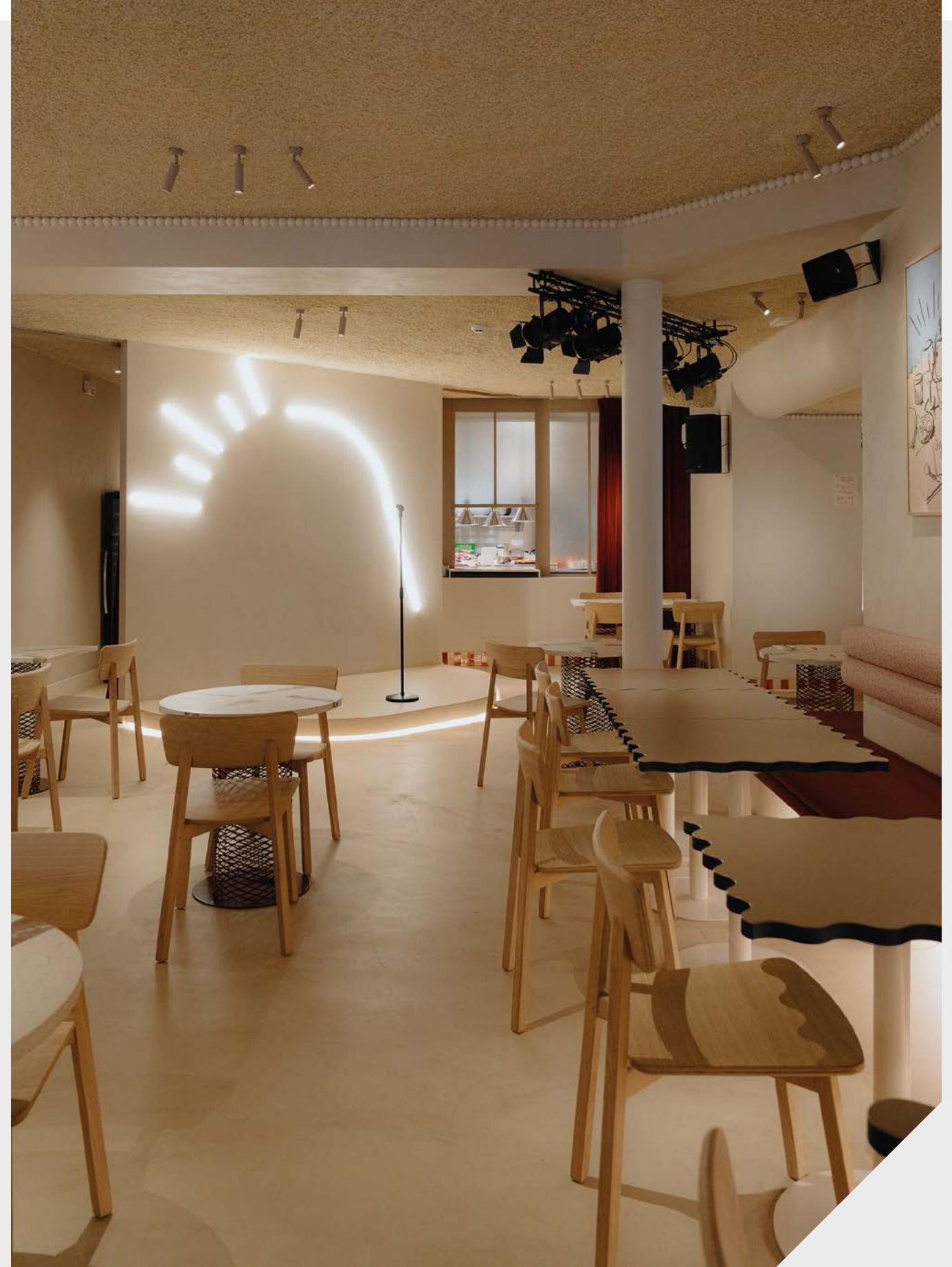

PET mini LED spot

Chez Guillaume, Namur

Design: Luce | Photo: I am Liz

OFFICE

Oprawy zaprojektowane do biur łączą nowoczesny design z wyjątkowymi parametrami technicznymi. Wspierają koncentrację pracowników, poprawiają ich komfort pracy, tworząc zarazem atmosferę sprzyjającą wydajności.

Luminaires designed for office spaces combine modern design with outstanding technical performance. They support employee focus, enhance workplace conditions and create an atmosphere conducive to productivity.

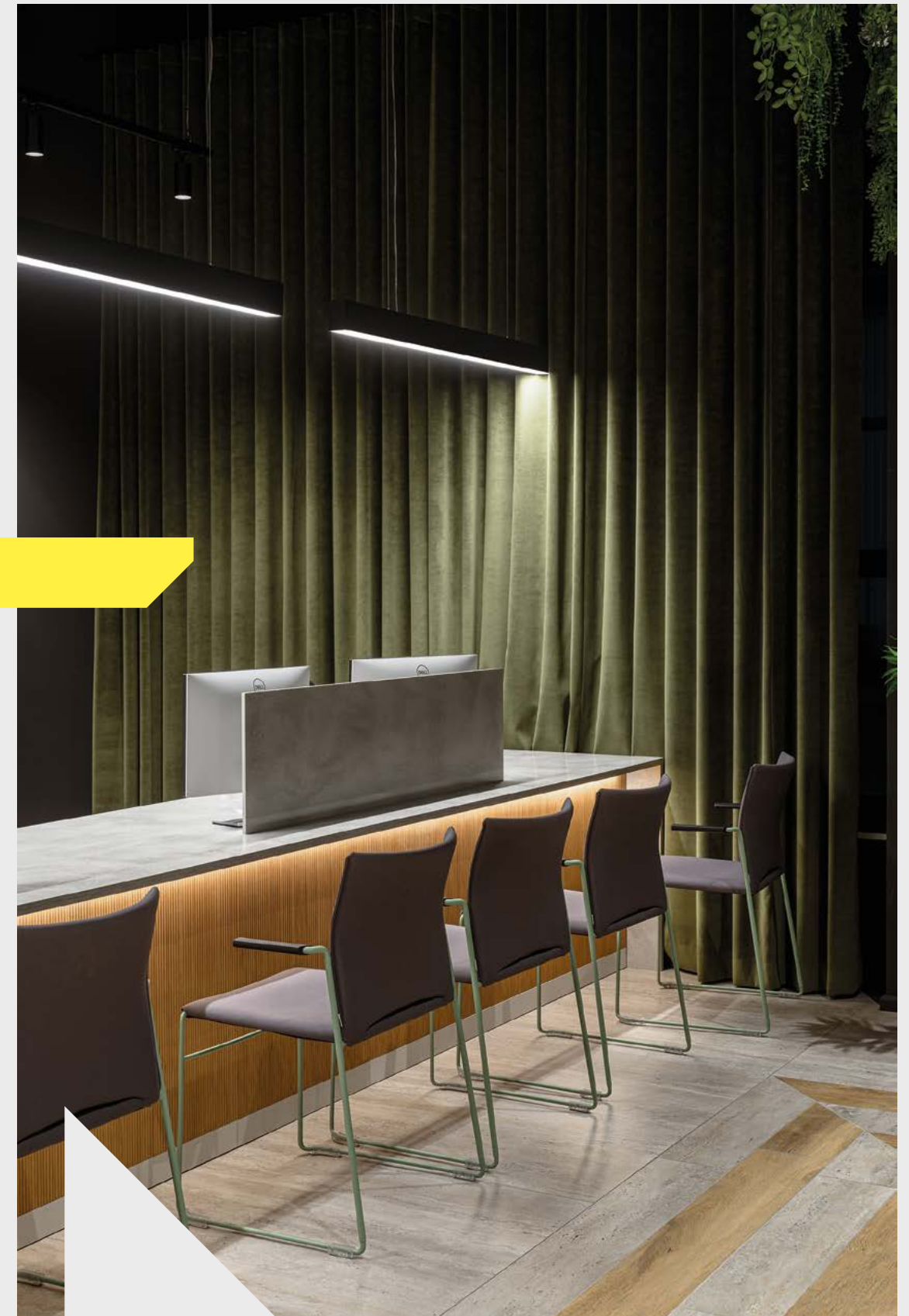
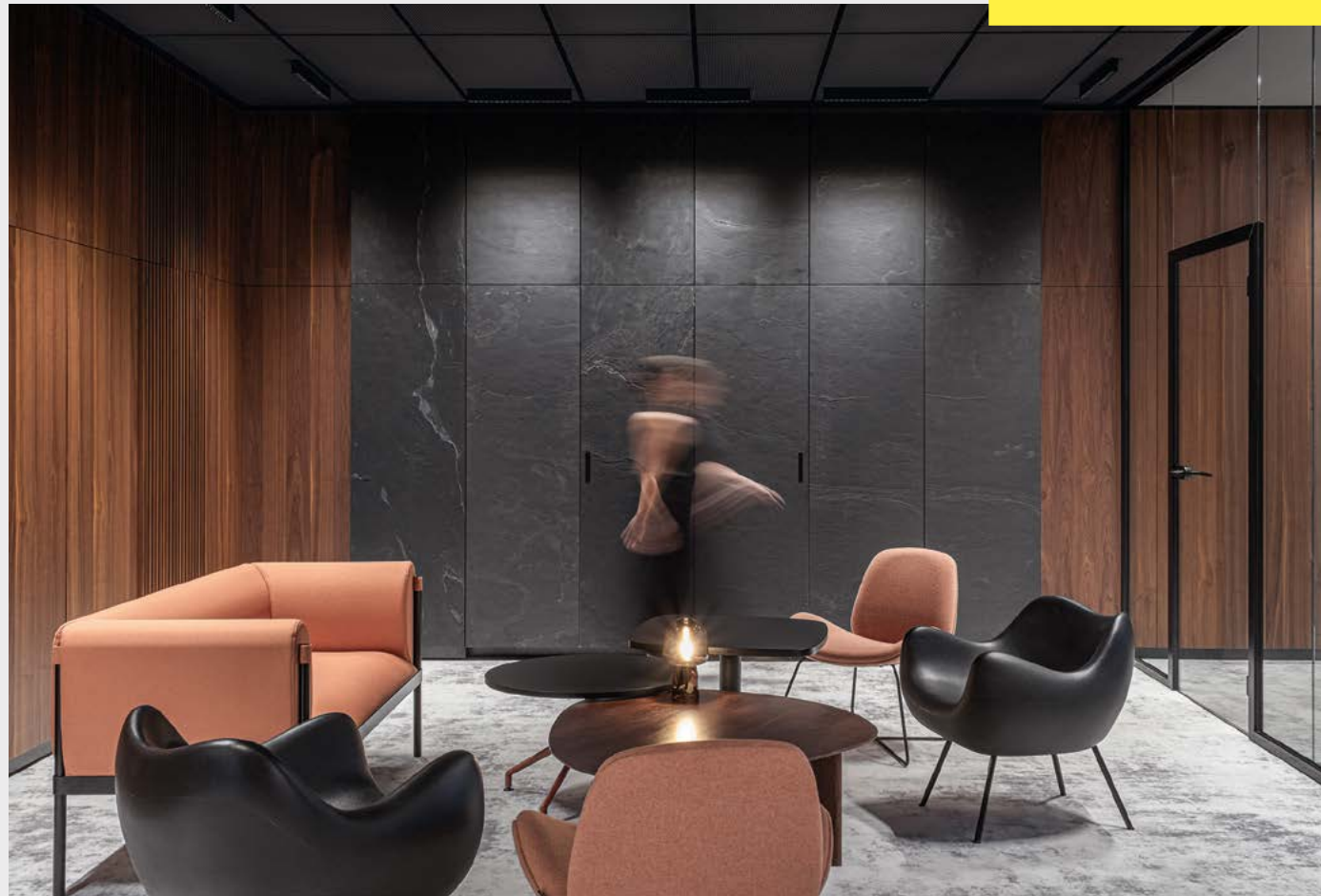
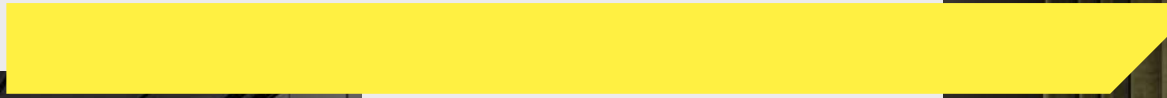

RETAIL

Mercedes-Benz Mojsiuk showroom, Koszalin



Poza najwyższą jakością, nasze oprawy cechuje wyjątkowa wszechstronność i elastyczność. Dzięki temu doskonale sprawdzają się w przestrzeniach ekspozycyjnych, takich jak sklepy, salony czy galerie.

Beyond the highest quality, our luminaires are distinguished by their versatility and flexibility. As a result, they perform effectively in display spaces such as shops, showrooms and galleries.

RAFTER points LED track

PET midi LED track

Your Art Maison Art Gallery, Warszawa



WHAT ABOUT

In our new catalogue, you will find the latest product releases along with an expanded range of available fixture colours. To support project work, we have introduced a clearer structure to the offer. Hermetic fixtures have been moved from the Outdoor section and reorganised by mounting type. The Track & Spot section has been renamed Track, and spot fixtures are now grouped according to installation method. Clearer and more transparent tables of contents also make navigating the catalogue easier.

W naszym nowym katalogu znajdziesz najświeższe nowości produktowe oraz rozszerzoną paletę dostępnych kolorów opraw. Z myślą o wygodzie podczas pracy projektowej, wprowadziliśmy czytelniejszą strukturę oferty. Oprawy hermetic zostały przeniesione z działu Outdoor i uporządkowane według rodzaju montażu. Dział Track & Spot zmienił nazwę na Track, a oprawy typu spot zostały uporządkowane według sposobu instalacji. Przegląd katalogu ułatwiają też bardziej czytelne i przejrzyste spisy treści.

DIVIDING

THE INTERIOR
INTO ZONES

RIBBY circle up&down LED suspended | RIBBY line up&down LED suspended | RIBBY up&down LED wall

WHAT IS NEW

W naszej nowej ofercie czeka na Ciebie jeszcze szerszy wybór opraw dekoracyjnych o parametrach charakterystycznych dla oświetlenia architektonicznego. Nie zabraknie też nastrojowych rozwiązań, które wniosą do wnętrza niepowtarzalny klimat, a także znanych kolekcji w odświeżonej, nowoczesnej odsłonie.

In our new offer, you will find an even wider selection of decorative fixtures with parameters characteristic of architectural lighting. You will also discover atmospheric solutions that introduce a distinctive mood to any interior, as well as well-known collections presented in a refreshed, modern form.



RIBBY round up&down LED suspended

Beads

[p. 236](#)
[p. 240](#)
[p. 572](#)

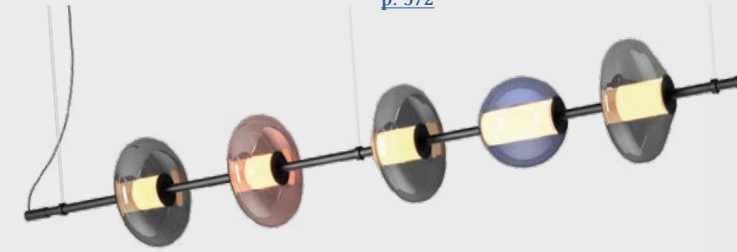

Cast ball



[p. 176](#)

Ribby

[p. 244](#)
[p. 248](#)
[p. 466](#)



Qrled next E



[p. 132](#)

Buclo

[p. 252](#)
[p. 256](#)

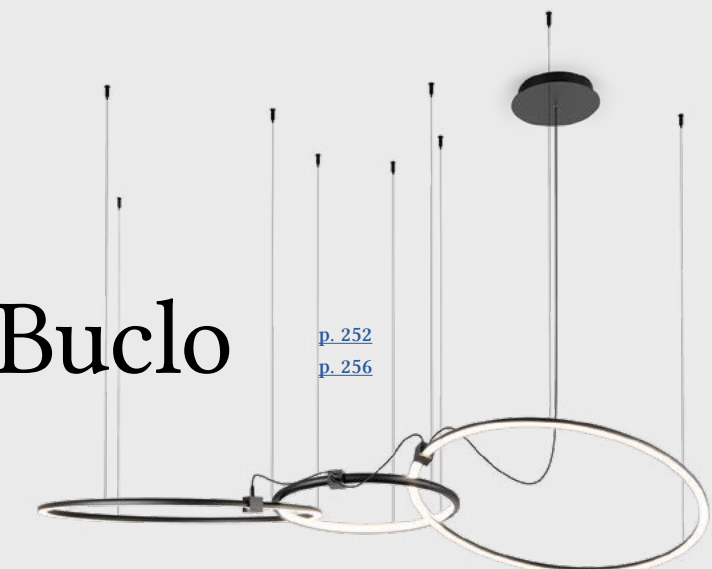

DELIVERY NEEDED ASAP?

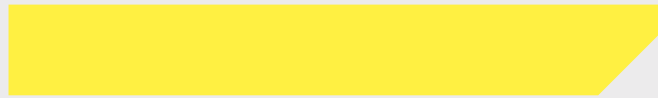

Oprawy potrzebne na już? Żaden problem! Sięgnij do naszej oferty Quick Shipment, w której znajdziesz produkty dostępne niemalże od ręki. Dzięki zoptymalizowanym procesom, oprawy są wysyłane z naszego magazynu w ciągu zaledwie 2-5 dni roboczych.

Need fixtures right away? No problem! Explore our Quick Shipment offer, where you will find products available almost immediately. Thanks to optimised processes, fixtures are shipped from our warehouse within just 2-5 business days.



NO PROBLEM

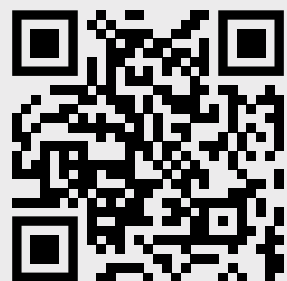

LET'S PLAY WITH COLOURS

Odkryj szeroką paletę kolorów, które podkreślą charakter każdego wnętrza! Oprócz standardowych odcieni, większość opraw dostępna jest również w modnych tonacjach taupe i terakota. Teraz oferta została dodatkowo poszerzona o nowe warianty: burgund oraz sandy. A dla wszystkich zwolenników bardziej surowych tonacji mamy dobrą wiadomość – zakres opraw dostępnych w wersji brutal został rozszerzony o oprawy z kolekcji PET, EMOT, TRU, RAFTER, MIXLINE, OPTIMA, oraz HOLLOW. Na zamówienie oferujemy oprawy w dowolnym kolorze z palet RAL lub NCS.

Discover a wide palette of colours that will highlight the character of any interior! Beyond standard finishes, most luminaires are also available in on-trend taupe and terracotta tones. The range has now been further expanded with new options: burgundy and sandy. For those who favour more raw aesthetics, the range of fixtures available in the brutal finish has been extended to include pieces from the PET, EMOT, TRU, RAFTER, MIXLINE, OPTIMA and HOLLOW collections. On request, fixtures are available in any colour from the RAL or NCS palettes.



VYRO x2 round LED 230V surface | VYRO x1 round LED 230V surface



PET mini LED suspended custom colour

LET'S PLAY WITH NEW COLOURS

KLIVA E27 surface | KLIVA LED suspended | KLIVA E27 suspended

Zabawa kolorem we wnętrzu nigdy nie była tak inspirująca! Oprócz modnego taupe i terakota, większość opraw jest teraz dostępna również w nowych odcieniach burgund i sandy. To jednak nie wszystko! Część opraw, jak KLIVA czy CONA, zachwycają nowymi, żywymi kolorami: niebieskim, żółtym i zielonym. Również dla opraw zewnętrznych przygotowaliśmy efektowny odcień corten, przypominający rdzawą stal. Dzięki tak barwnej palecie, nasze oświetlenie pozwala tworzyć aranżacje pełne energii, stylu i niepowtarzalnej atmosfery.



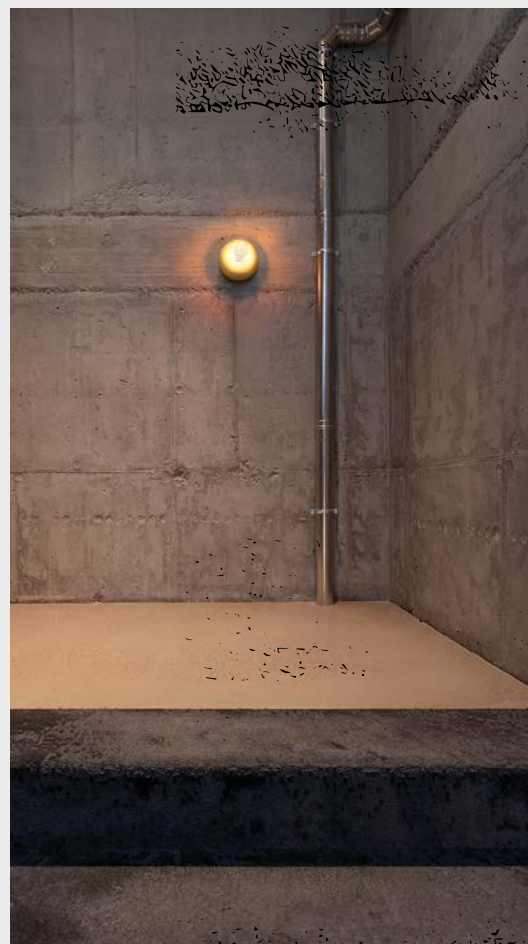
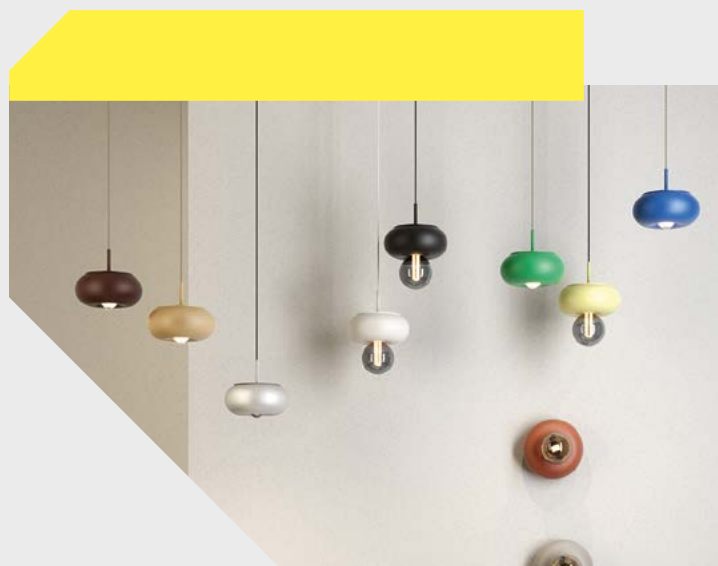



























Exploring colour in interiors has never been so inspiring! In addition to the trendy taupe and terracotta tones, most fixtures are now available in new shades of burgundy and sandy. This is not all. Selected fixtures, such as KLIVA and CONA, are not offered in vivid new colours: blue, yellow, and green. For outdoor fixtures, we have introduced a striking corten finish reminiscent of weathered steel. With such a rich palette, our lighting enables the creation of arrangements full of energy, style, and a distinctive atmosphere.























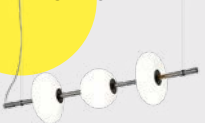















CONA LED suspended | KLIVA E27 surface | MAXI POINT LED wall

ALL PRODUCTS

by name

RECESSED BIG SIZE  p. 100	HOLLOW  p. 080 - 086	HYPER zoom  p. 094	LENS LINE  p. 118	MIXLINE  p. 116	PET  p. 092
PUTT  p. 068 - 076	QRLED next  p. 062 - 066	RAFTER  p. 112	RAFTER mix  p. 114	RAFTER points  p. 104 - 106	RAFTER wallwasher  p. 110
RING rim  p. 098	SET TRU  p. 122	SET RAW mini  p. 120	SIRCA  p. 096	SWING next  p. 088	TRIBA  p. 090
SURFACE CAST BALL  new p. 176	BIG SIZE  p. 202	BLOS cast  p. 194	BLOS round  p. 198	HYPER zoom  p. 168	KLIVA  p. 144
LENS LINE  p. 220	MIXLINE  p. 214	MODERN BALL simple  p. 178	MODERN BALL  p. 182	PET asymmetry  new p. 164	PET E  p. 164

PET  p. 154 - 162	QRLED next  new p. 132 - 136	RAFTER  p. 210	RAFTER mix  p. 212	RAFTER points  p. 206	RING dot  p. 186
RING rim  p. 192	SET TRU  p. 224	SNOP  p. 140	TRIBA  p. 148 - 152	VYRO round  p. 172	VYRO square  p. 172
SUSPENDED BEADS line  new p. 236 - 240	BEADS  new p. 236 - 240	BIG SIZE  p. 314	BLOS round  p. 312	BUCLO  new p. 252 - 256	CONA  p. 262
FLARED cast  p. 270	FLYING BALL  p. 294	IKI  p. 272	KLIVA  p. 280	LENS LINE section  p. 322	MIXLINE  p. 324
MODERN BALL  p. 298	MODERN GLASS mini  new p. 286	MODERN GLASS  new p. 290	OPTIMA  p. 332	PET  p. 306	PET mini horiz  new p. 304
PIPER  p. 274	QRLED next  p. 278	RAFTER  p. 330	RAFTER points  p. 328	RIBBY circle  p. 244	RIBBY line  new p. 248

ALL PRODUCTS by name

RIBBY round new p. 244	RING dot p. 310	SET RAW mini p. 320	SET TRU p. 338	SNOP p. 266	THIN TUBE p. 316
TRIBA p. 282	TRACK HIGH MULTITRACK p. 380	MULTITRACK p. 368	MICROTRACK p. 392	TRACK 3F p. 398	ALULINE mini new p. 428
BLOS round p. 446	HYPER zoom p. 426	MODERN BALL simple p. 448	PET p. 420	PET mini p. 416	QRLED next p. 408
RAFTER p. 436	RAFTER mini p. 430	RAFTER mini points p. 432	RAFTER points p. 438	SET TRU mini p. 442	TUBE flex p. 444
TUBE stiff p. 444	TRIBA p. 412 - 414	WALL EMOT new p. 460	IKI round p. 482	MAXI POINT p. 484	MODERN GLASS tube new p. 480

PET p. 472	PET micro p. 474	PIPER 230V p. 486	RAFTER p. 494	RIBBY new p. 466	SET RAW mini p. 490
SET TRU p. 496	THIN TUBE p. 492	TRIBA p. 470	FLOOR, TABLE, PORTABLE MODERN BALL p. 514		MROOM p. 510
THIN TUBE p. 520	OUTDOOR DART p. 558	DART 24V new p. 556	KYO 24V new p. 532	LEDPOINT round p. 540	LEDPOINT square p. 540
MAXI POINT p. 548	ONLY p. 536	PET p. 538	SENSO new p. 534	SLUP p. 552	VIP round p. 544
VIP square p. 544	SYSTEMS ALULINE p. 600	BEADS new p. 572	LEDLINE p. 602	MIXLINE p. 606	OPTIMA new p. 578
PET rift p. 596	PIPER new p. 590	RAFTER mix p. 618	SET RAW mini p. 610	SPIDER p. 584	TRU p. 614

INTERIOR RECESSED

























LIGHT INTEGRATED
INTO ARCHITECTURE

INTERIOR RECESSED

PRODUCTS

RECESSED QRLED next trim

 p. 062	 p. 062	 p. 062	 p. 062	 p. 068	 p. 072
 p. 074	 p. 074	 p. 080	 p. 080	 p. 086	 p. 086
 p. 088	 p. 088	 p. 096	 p. 098	 p. 100	 p. 104

 p. 104	 p. 106	 p. 106	 p. 110	 p. 110	 p. 112
 p. 114	 p. 116	 p. 116	 p. 118	 p. 118	 p. 118
 p. 118	 p. 120	 p. 122			
 p. 066	 p. 090	 p. 092	 p. 094	 p. 106	
 p. 076	 p. 076	 p. 084	 p. 084		

INTERIOR RECESSED

Recessed luminaires subtly integrate with their surroundings. They allow precise light shaping while maintaining clean detailing and visual order in both private and commercial spaces.

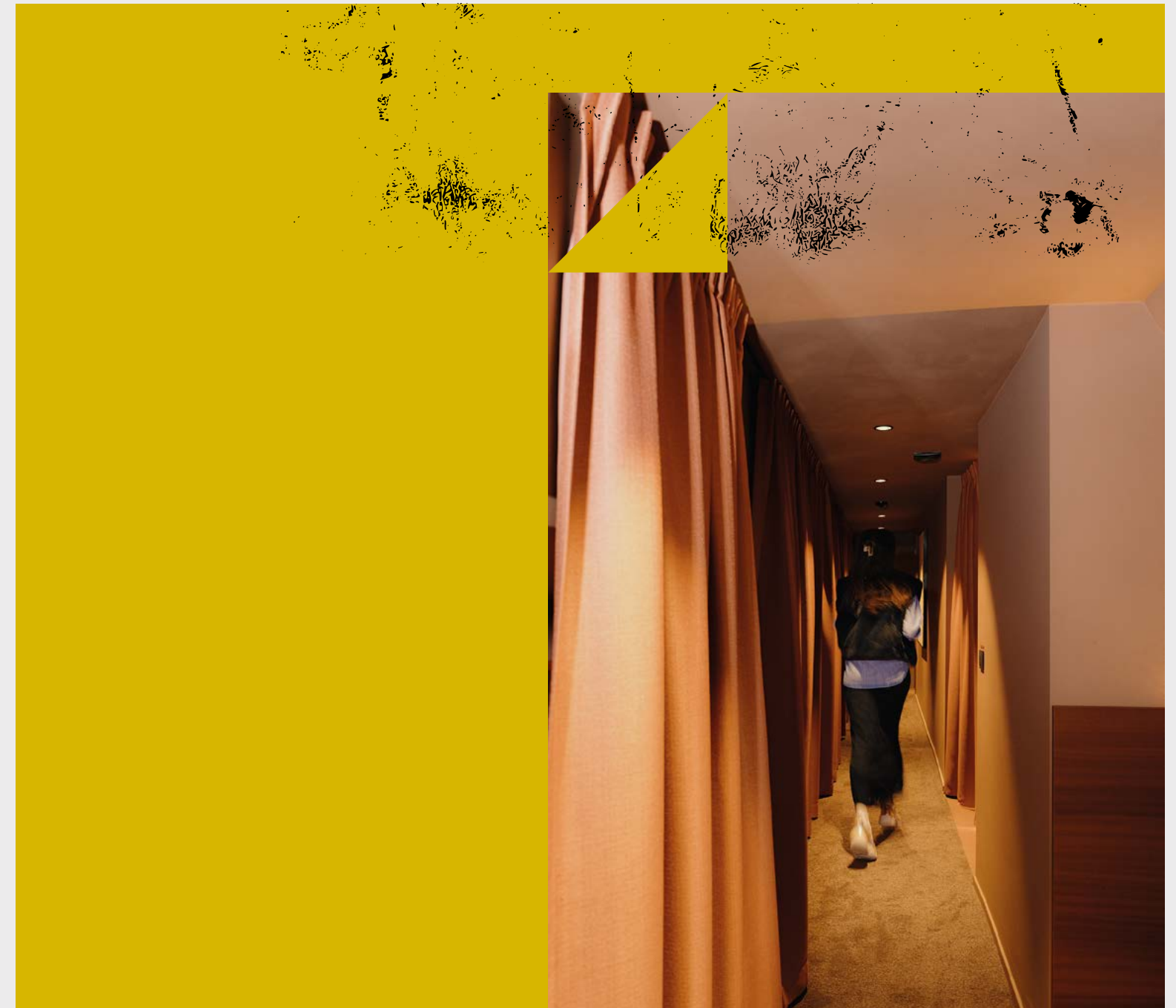

PRECISE LIGHT
IN A CONTEMPORARY FORM

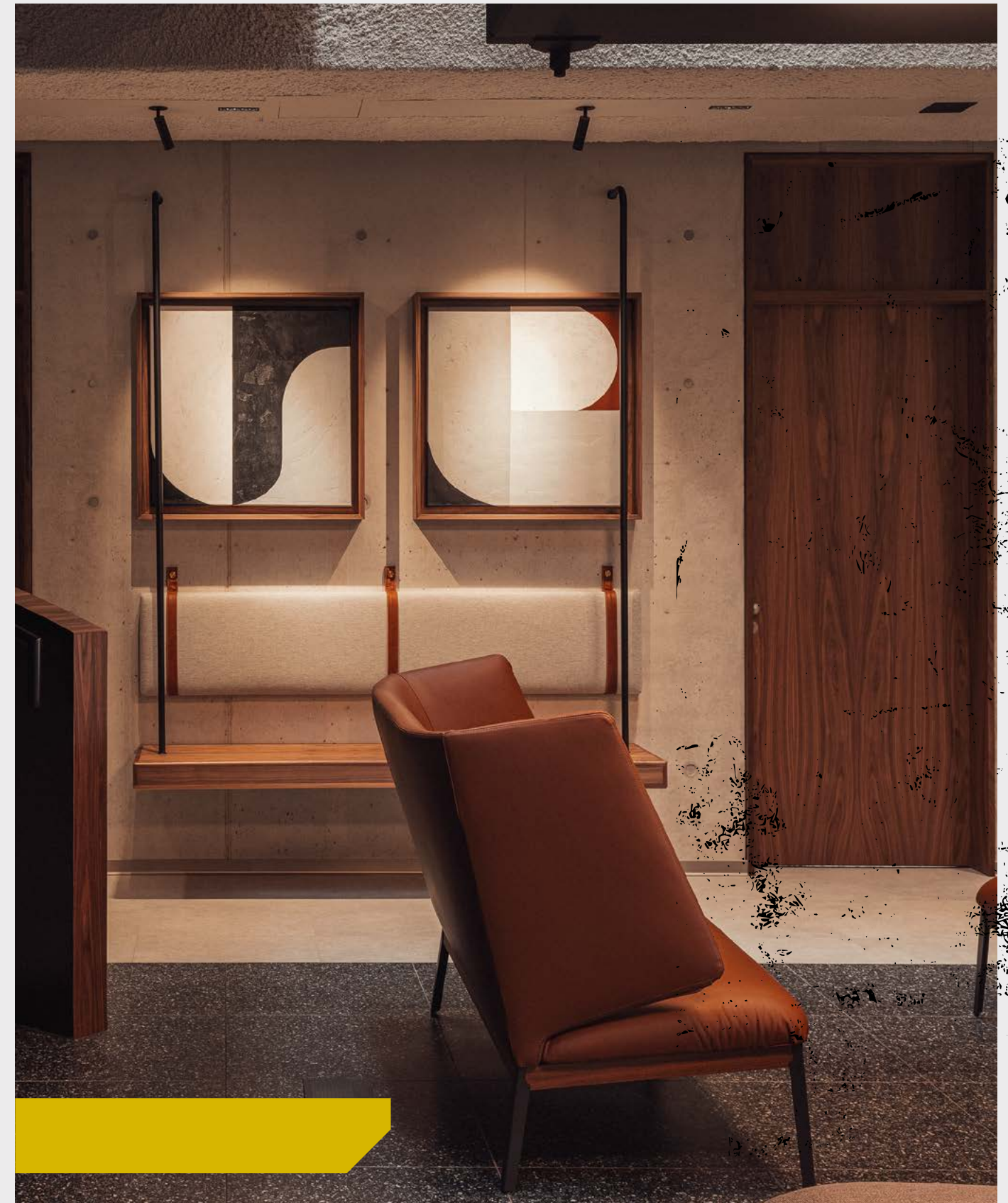
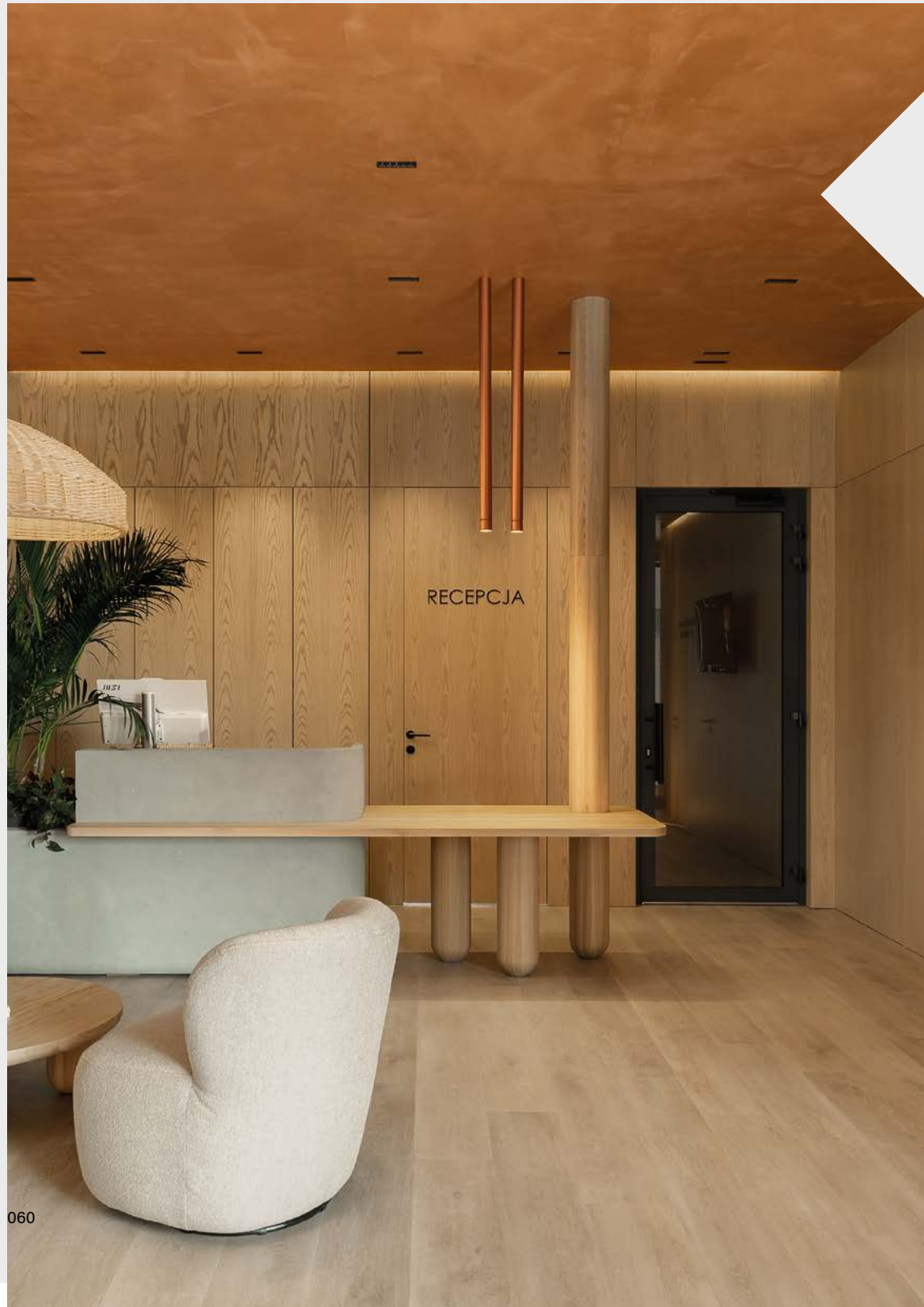



QRLED_next

QRLED next is an improved version of one of AQForm's bestsellers. New optics, simplified installation and increased luminous efficacy ensure a well-balanced lighting effect suited to everyday use. The recessed version offers precise spot lighting and seamless integration with the ceiling, allowing the luminaire to be harmoniously matched to the function and character of the interior.

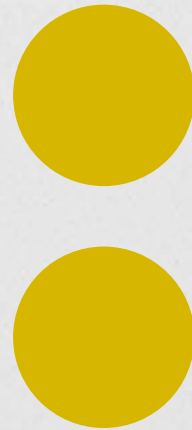

recessed

surface p. 132-136

suspended p. 278

Track p. 408

systems p. 584



QRLED next trim | move trim | trimless | move trimless

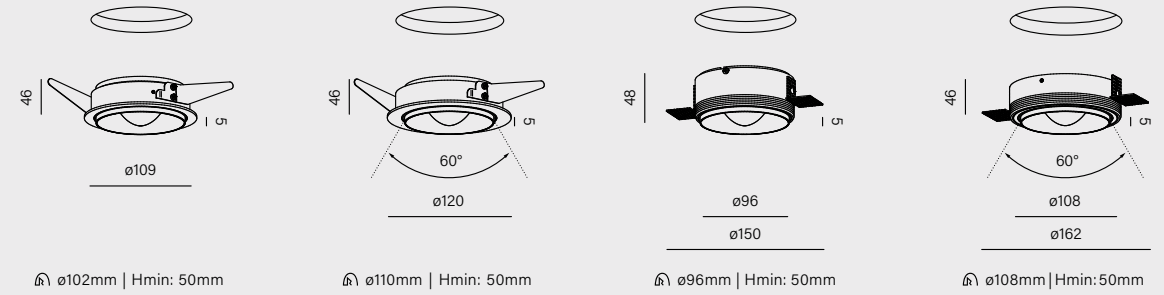

cat. n°	cat. n°	cat. n°	cat. n°
38061-M930-W3-00-12	38063-M930-W3-00-12	38062-M930-W3-00-12	38064-M930-W3-00-12
power: 6W (L) 9W (M) 9W (A)			
flux: 834lm - 1134lm			
optics: 52° (W_)			
CCT: 2700K (27) 3000K (30) 4000K (40)			
CC driver: (G) 350mA 25.1V			
control: ON/OFF (00) Phase-Control (PH) DALI (DA) require driver (CC)*			

* Protection class, input voltage and IP rating for CC luminaires vary from above [table](#).
For trimless luminaires, it is possible to order the mounting frame and the luminaire insert separately.
More information can be found in the technical brochure.



luminaire finishes

- white -13 ○
- black -12 ●
- burgundy -86 ●
- terracotta -83 ●
- sandy -87 ●
- taupe -82 ●
- grey -84 ●
- gold -19 ●
- mix -06 ●

main material

aluminium | optical glass | PPE+PA



QRLED next spot

QRLED next spot is a compact fixture that, despite its small dimensions, offers high luminous efficacy. The tiltable module allows the light beam to be directed precisely where required, highlighting details, wall textures or elements of the interior arrangement. Its neutral form allows the spotlight to integrate naturally into modern spaces.



recessed

surface p. 132-136

suspended p. 278

track p. 408

systems p. 584



QRLED next SR spot

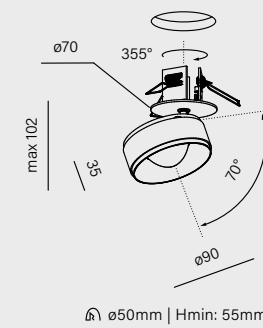

cat. n°	
	16480-M930-W3-00-12
power:	6W (L) 9W (M) 9W (A)
flux:	834lm - 1134lm
optics:	52° (W_)
CCT:	2700K (27) 3000K (30) 4000K (40)
CC driver:	(G) 350mA 25.1V
control:	ON/OFF (00) Phase-Control (PH) DALI (DA) require driver (CC)*

* Protection class, input voltage and IP rating for CC luminaires vary from above [table](#).

luminaire finishes

- white -13 ○
- black -12 ●
- burgundy -86 ●
- terracotta -83 ●
- sandy -87 ●
- taupe -82 ●
- grey -84 ●
- gold -19 ●
- mix -06 ●

main material

aluminium | optical glass | PPE+PA



PUTT



PUTT LED mini | midi | maxi

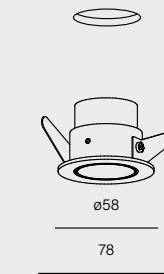

∅ 50mm | Hmin: 50mm

cat. n°

38013-M930-WB-00-12

power: 4.5W (M) | 4.5W (A)

flux: 543lm

optics: 20° (S_) | 41° (W_)

CCT: 2700K (27) | 3000K (30) | 4000K (40)

CC driver: (B) 500mA | 8.6V

control: ON/OFF (00) | Phase-Control (PH) | require driver (CC)*

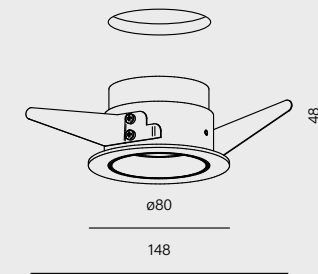

∅ 70mm | Hmin: 60mm

cat. n°

38015-M930-WB-00-12

power: 8.5W (M) | 8.5W (A)

flux: 1149lm

optics: 18° (S_) | 35° (F_) | 50° (W_)

CCT: 2700K (27) | 3000K (30) | 4000K (40)

CC driver: (H) 250mA | 34.2V

control: ON/OFF (00) | Phase-Control (PH) | DALI (DA) | require driver (CC)*

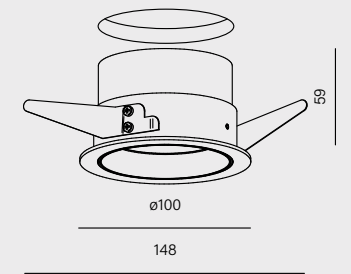

∅ 90mm | Hmin: 70mm

cat. n°

38017-M930-WB-00-12

power: 11.5W (L) | 17W (M) | 17W (A)

flux: 1617lm - 2261lm

optics: 19° (S_) | 32° (F_) | 63° (W_)

CCT: 2700K (27) | 3000K (30) | 4000K (40)

CC driver: (L) 500mA | 33.6V

control: ON/OFF (00) | Phase-Control (PH) | DALI (DA) | require driver (CC)*



* Protection class, input voltage and IP rating for CC luminaires vary from above table.

accessory

honeycomb



ring finishes

- white -_W
- black -_B
- burgundy -_U
- terracotta -_R
- sandy -_D
- taupe -_T
- grey -_A
- gold -_G

luminaire finishes

- white -13
- black -12
- burgundy -86
- terracotta -83
- sandy -87
- taupe -82
- grey -84
- gold -19

main material

aluminium

recessed

PUTT

LIGHT INTEGRATED INTO ARCHITECTURE



Depending on the selected beam angle, PUTT offers either versatile general lighting or focused accent illumination. Available in a range of colour finishes, its recessed light source reduces glare, ensuring high visual ease of use. Its simple, neutral form allows it to integrate harmoniously into interiors of varied styles, from private to commercial.

HARMONY OF LIGHT,
FORM AND ERGONOMICS

PUTT trimless

PUTT trimless is installed flush with the ceiling surface, without a visible frame, creating the impression of a unified plane. Its discreet form allows the attention to remain focused on the light and the interior architecture. An ideal choice for projects where aesthetically cohesive and high-quality finishes are essential.



PUTT LED trimless mini | midi | maxi

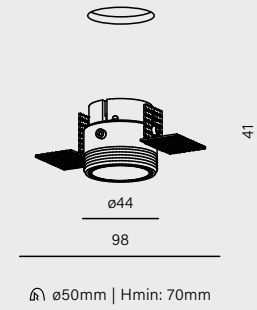

cat. n°

38014-M930-WB-00-12

power: 4.5W (M) | 4.5W (A)

flux: 543lm

optics: 20° (S_) | 41° (W_)

CCT: 2700K (27) | 3000K (30) | 4000K (40)

CC driver: (B) 500mA | 8.6V

control: ON/OFF (00) | require driver (CC)*

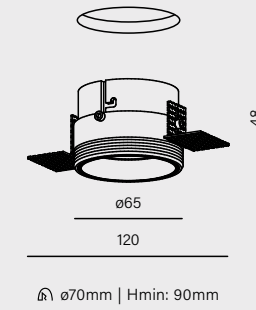

cat. n°

38016-M930-WB-00-12

power: 8.5W (M) | 8.5W (A)

flux: 1149lm

optics: 18° (S_) | 35° (F_) | 50° (W_)

CCT: 2700K (27) | 3000K (30) | 4000K (40)

CC driver: (H) 250mA | 34.2V

control: ON/OFF (00) | Phase-Control (PH) | DALI (DA) | require driver (CC)*

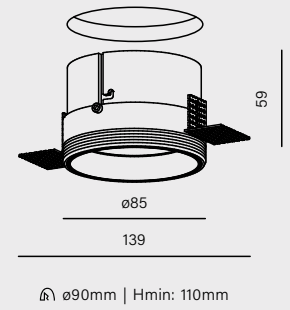

cat. n°

38018-M930-WB-00-12

power: 11.5W (L) | 17W (M) | 17W (A)

flux: 1617lm - 2261lm

optics: 19° (S_) | 32° (F_) | 63° (W_)

CCT: 2700K (27) | 3000K (30) | 4000K (40)

CC driver: (L) 500mA | 33.6V

control: ON/OFF (00) | Phase-Control (PH) | DALI (DA) | require driver (CC)*



* Protection class, input voltage and IP rating for CC luminaires vary from above [table](#).

For trimless luminaires, it is possible to order the mounting frame and the luminaire insert separately. More information can be found in the technical brochure.

accessory

honeycomb



ring finishes

- white -_W
- black -_B
- burgundy -_U
- terracotta -_R
- sandy -_D
- taupe -_T
- grey -_A
- gold -_G

luminaire finishes

- white -13
- black -12
- burgundy -86
- terracotta -83
- sandy -87
- taupe -82
- grey -84
- gold -19

main material

aluminium

PUTT move

PUTT move allows the light source to tilt, enabling flexible accent lighting within the space. It retains a discreet character and compact size while offering high functionality, making it an ideal solution for interiors that require adaptable lighting scenes.

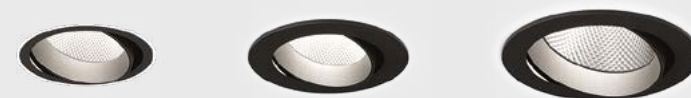

PUTT move LED midi trimless | midi | maxi

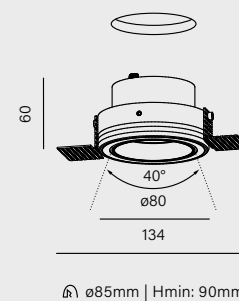

cat. n°

38043-M930-FB-00-12

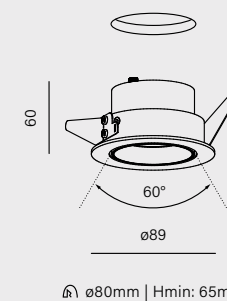

cat. n°

38042-M930-FB-00-12

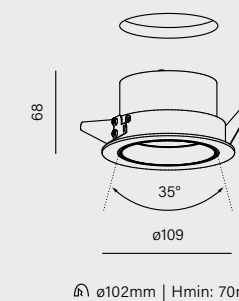

cat. n°

38044-M930-FB-00-12

power:	8.5W (M) 8.5W (A)	11.5W (L) 17W (M) 17W (A)
flux:	1149lm	1617lm - 2261lm
optics:	18° (S_) 35° (F_) 50° (W_)	19° (S_) 32° (F_) 63° (W_)
CCT:	2700K (27) 3000K (30) 4000K (40)	
CC driver:	(H) 250mA 34.2V	(L) 500mA 33.6V
control:	ON/OFF (00) Phase-Control (PH) DALI (DA) require driver (CC)*	



*not for midi trimless | * Protection class, input voltage and IP rating for CC luminaires vary from above [table](#).

For trimless luminaires, it is possible to order the mounting frame and the luminaire insert separately. More information can be found in the technical brochure.

accessory

honeycomb



ring finishes

- white -_W
- black -_B
- burgundy -_U
- terracotta -_R
- sandy -_D
- taupe -_T
- grey -_A
- gold -_G

luminaire finishes

- white -13
- black -12
- burgundy -86
- terracotta -83
- sandy -87
- taupe -82
- grey -84
- gold -19

main material

aluminium

PUTT_hermetic

PUTT hermetic is a recessed luminaire with an enhanced ingress protection rating, designed for demanding environments. Its recessed light source supports ease of use and reduces glare. Available in several versions, including an adjustable option, it allows functional and aesthetically refined lighting solutions to be created in bathrooms, wellness areas and utility spaces.



PUTT LED hermetic mini | midi | midi move

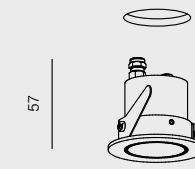

ø58

⌀ ø50mm | Hmin: 65mm

cat. n°

38046-M930-WW-00-12

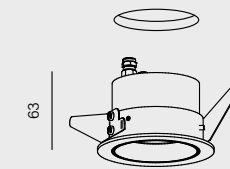

ø80

⌀ ø70mm | Hmin: 70mm

cat. n°

38045-M930-WW-00-12

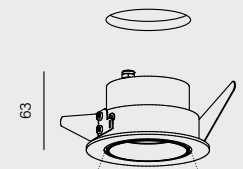

ø89

⌀ ø80mm | Hmin: 65mm

cat. n°

38047-M930-WW-00-12

power:	4.5W (M) 4.5W (A)	8.5W (M) 8.5W (A)
flux:	543lm	1149lm
optics:	20° (S_) 41° (W_)	18° (S_) 35° (F_) 50° (W_)
CCT:	2700K (27) 3000K (30) 4000K (40)	
CC DRIVER:	(B) 500mA 8.6V	(H) 250mA 34.2V
control:	ON/OFF (00) Phase-Control (PH) require driver (CC)*	

* Protection class, input voltage and IP rating for CC luminaires vary from above [table](#).

accessory

honeycomb

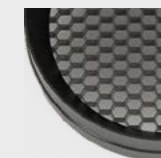

ring finishes

- white -_W ○
- black -_B ●
- burgundy -_U ●
- terracotta -_R ●
- sandy -_D ●
- taupe -_T ●
- grey -_A ●
- gold -_G ●

luminaire finishes

- white -13 ○
- black -12 ●
- burgundy -86 ●
- terracotta -83 ●
- sandy -87 ●
- taupe -82 ●
- grey -84 ●
- gold -19 ●

main material
aluminium

HOLLOW

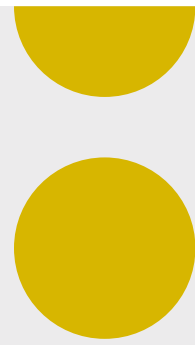

The HOLLOW family has been expanded to include the full range of AQForm's standard colour finishes, including taupe, terracotta and brutal, making it easier to achieve coherent matching of fixtures with project requirements. In addition, a new mounting version designed for installation in concrete has been introduced, extending the scope of applications in contemporary architectural projects.

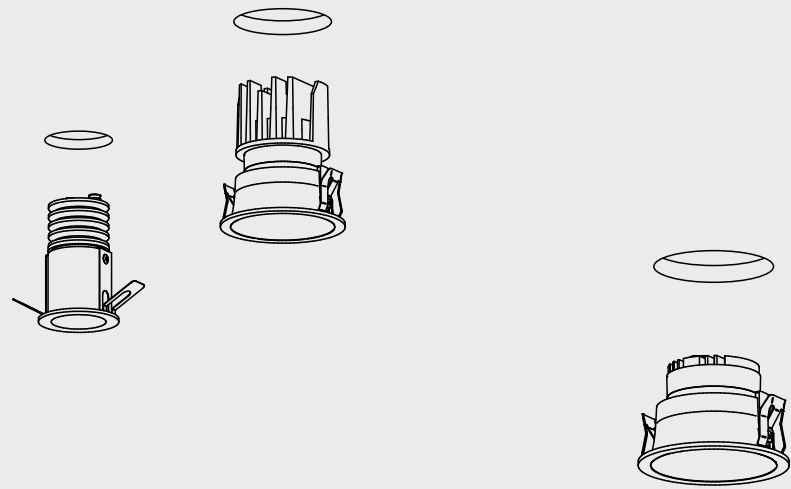

EYE-FRIENDLY LIGHT

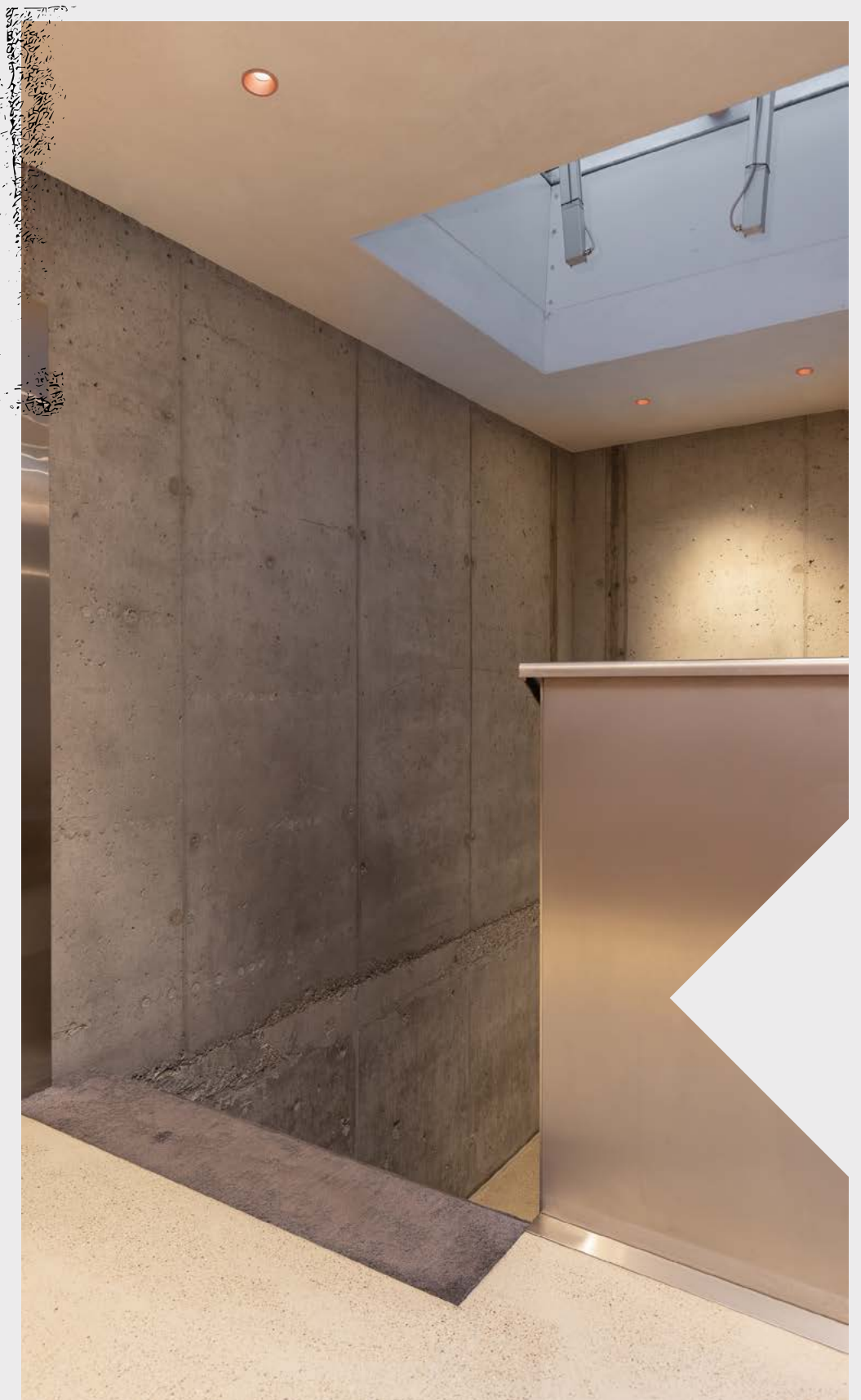



HOLLOW_

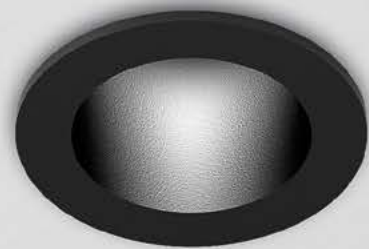

HOLLOW features a deeply recessed light source that minimises glare and supports ease of use. Available in multiple diameters, colours, and beam angles, it allows the lighting effect to be precisely matched to the interior's function while remaining a discreet element of the arrangement.



HOLLOW LED micro | 6 | 8 lens | 8

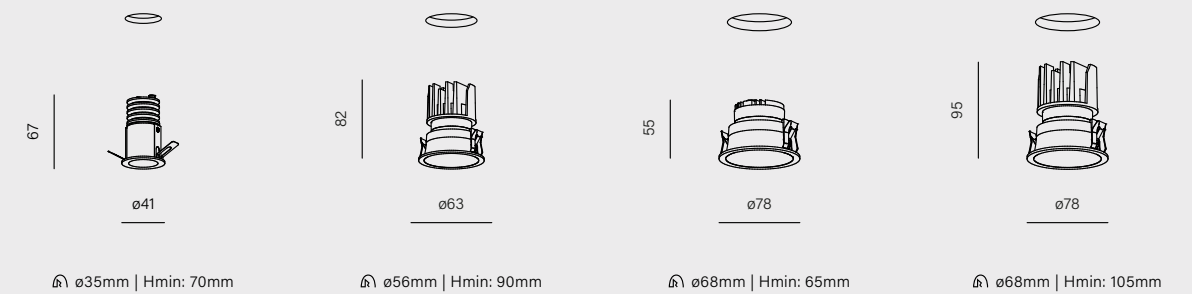

	cat. n°	cat. n°	cat. n°	cat. n°
	37986-M930-FB-00-12	38058-M930-WB-00-12	38055-M930-FB-00-12	38051-M930-WB-00-12
power:	2.5W (M) 2.5W (A)	6W (M) 6W (A)		8.5W (M) 8.5W (A)
flux:	223lm	794lm		1097lm
optics:	30° (F_)	49° (W_)	34° (F_)	41° (W_)
CCT:	2700K (27) 3000K (30) 4000K (40)			
CC driver:	(A) 700mA 2.9V	(D) 350mA 16.7V		(E) 500mA 17.2V
control:	ON/OFF (00) require driver (CC)*		ON/OFF (00) Phase-Control (PH) DALI (DA) require driver (CC)*	

* Protection class, input voltage and IP rating for CC luminaires vary from above table.

- ring finishes**
- white -_W ○
- black -_B ●
- natural -_N ○¹
- burgundy -_U ●
- terracotta -_R ●
- sandy -_D ●
- taupe -_T ●
- grey -_A ●
- gold -_G ●
- luminaire finishes**
- white -13 ○
- black -12 ●
- brutal -85 ○¹
- burgundy -86 ●
- terracotta -83 ●
- sandy -87 ●
- taupe -82 ●
- grey -84 ●
- gold -19 ●

every color variant of the luminaires can only be ordered with its equivalent (e.g.-12 and -_B)

¹ not for HOLLOW micro

main material
aluminium





ELEGANCE IN FORM
AND GLARE-FREE LIGHT

HOLLOW hermetic

HOLLOW hermetic combines a deeply recessed light source with enhanced resistance to moisture. As a result, it performs well in bathrooms, kitchens and other interiors that require additional protection. A wide range of diameters and beam angles allows the lighting effect to be precisely matched while maintaining an elegant, neutral form.



HOLLOW LED hermetic micro | 6 | 8 lens | 8

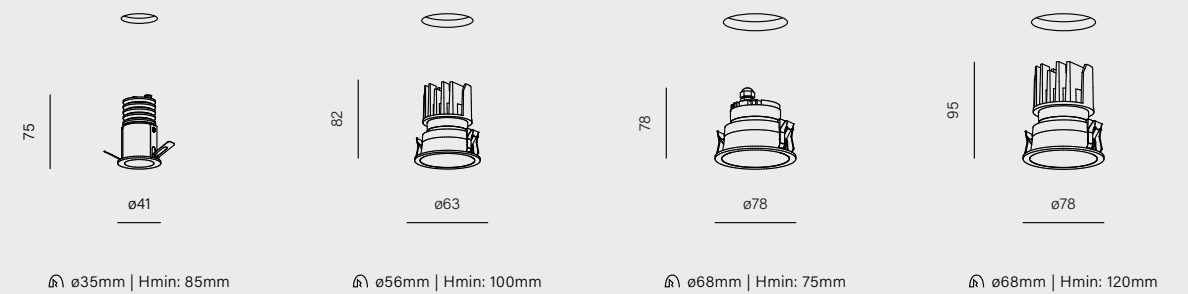

	cat. n°	cat. n°	cat. n°	cat. n°
	38011-M930-FB-00-12	38059-M930-WB-00-12	38056-M930-FB-00-12	38052-M930-WB-00-12
power:	2.5W (M) 2.5W (A)	6W (M) 6W (A)		8.5W (M) 8.5W (A)
flux:	223lm	794lm		1097lm
optics:	30° (F_)	49° (W_)	34° (F_)	41° (W_)
CCT:	2700K (27) 3000K (30) 4000K (40)			
CC DRIVER:	(A) 700mA 2.9V	(D) 350mA 16.7V		(E) 500mA 17.2V
control:	ON/OFF (00) require driver (CC)*			

* Protection class, input voltage and IP rating for CC luminaires vary from above table.

- ring finishes**
- white -_W ○
- black -_B ●
- natural -_N ○
- burgundy -_U ●
- terracotta -_R ●
- sandy -_D ●
- taupe -_T ●
- grey -_A ●
- gold -_G ●
- luminaire finishes**
- white -13 ○
- black -12 ●
- brutal -85 ○
- burgundy -86 ●
- terracotta -83 ●
- sandy -87 ●
- taupe -82 ●
- grey -84 ●
- gold -19 ●

every color variant of the luminaires can only be ordered with its equivalent (e.g.-12 and -_B)

¹ not for HOLLOW micro

main material
aluminium



HOLLOW move

HOLLOW move offers adjustable beam direction while retaining all the advantages of a deeply recessed light source. This solution allows selected interior elements to be accentuated and lighting scenes to be shaped flexibly. Its elegant form and eye-friendly illumination make it suitable for projects that require functionality and discreet aesthetics.



HOLLOW move LED 6 | 8 lens | 8

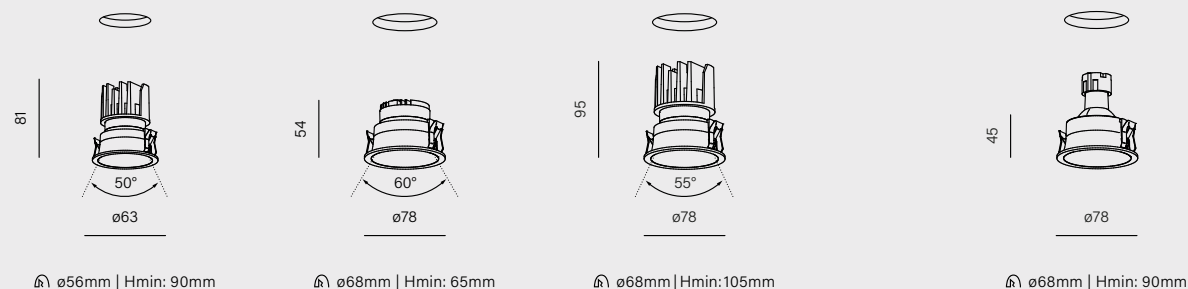

cat. n°	cat. n°	cat. n°	cat. n°
38060-M930-WB-00-12	38057-M930-FB-00-12	38053-M930-WB-00-12	38054-G000-00-PH-12
power: 6W (M) 6W (A)		8.5W (M) 8.5W (A)	power: max: 50W
flux: 794lm		1097lm	control: Phase-Control (PH)
optics: 49° (W_)	34° (F_)	41° (W_)	
CCT: 2700K (27) 3000K (30) 4000K (40)			
CC driver: (D) 350mA 16.7V		(E) 500mA 17.2V	
control: ON/OFF (00) Phase-Control (PH) DALI (DA) require driver (CC)*			



* Protection class, input voltage and IP rating for CC luminaires vary from above table.

inner finishes

only for HOLLOW move

- white -_W ○
- black -_B ●
- natural -_N ○
- burgundy -_U ●
- terracotta -_R ●
- sandy -_D ○
- taupe -_T ○
- grey -_A ●
- gold -_G ●

luminaire finishes

- white -13 ○
- black -12 ●
- brutal -85 ○
- burgundy -86 ●
- terracotta -83 ●
- sandy -87 ○
- taupe -82 ○
- grey -84 ●
- gold -19 ●

every color variant of the luminaries can only be ordered with its equivalent (e.g.-12 and -_B)

main material

aluminium



SWING

SWING next allows the light module to tilt, enabling precise illumination of selected interior elements. Reduced mounting height, simplified installation and the framed version increase the luminaire's versatility. Carefully designed optics make SWING a reliable choice for both private and commercial interiors.



recessed

SWING

LIGHT INTEGRATED INTO ARCHITECTURE

SWING next LED - | trimless

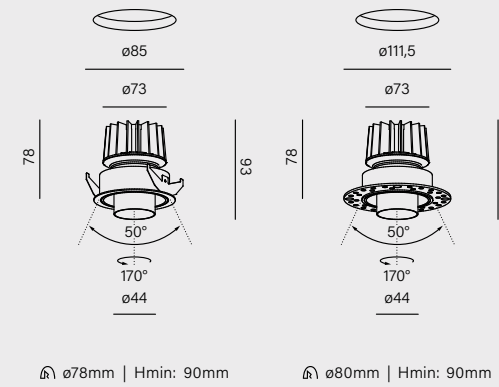

	cat. n°	cat. n°
	38035-M930-FW-00-12	38036-M930-FW-00-12
power:	12.5W (M) 12.5W (A)	
flux:	1553lm	
optics:	33° (F_) 54° (W_)	
CCT:	2700K (27) 3000K (30) 4000K (40)	
CC driver:	(I) 350mA 35.3V	
control:	ON/OFF (00) DALI (DA) require driver (CC)*	

* not for trimless version

* Protection class, input voltage and IP rating for CC luminaires vary from above [table](#).

accessory

81244 - Trimless hole saw 75x115x3



www.aqform.com

SWING next GU10 - | trimless

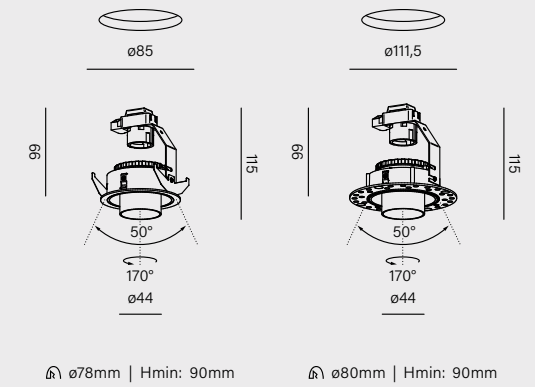

	cat. n°	cat. n°
	38069-G000-00-PH-12	38070-G000-00-PH-12
power:	max: 50W	
control:	Phase-Control (PH)	

light source not included

ring finishes

only for SWING next LED

- white -_W ○
- black -_B ●
- burgundy -_U ●
- terracotta -_R ●
- sandy -_D ●
- taupe -_T ●
- grey -_A ●
- gold -_G ●

luminaire finishes

- white -13 ○
- black -12 ●
- burgundy -86 ●
- terracotta -83 ●
- sandy -87 ●
- taupe -82 ●
- grey -84 ●
- gold -19 ●

every color variant of the luminaires can only be ordered with its equivalent (e.g.-12 and -_B)

main material

aluminium | ABS

Data for standard LED product is shown for LED light source 3000K. Other variants are available on our website.



TRIBA

TRIBA LED stands out with a slim, modern form and decorative, well-balanced proportions. Available in mini and midi versions, it enables precise light shaping thanks to a choice of beam angles and power options. This spotlight performs well in both private and commercial spaces, offering an aesthetic and functional solution for a wide range of arrangements.

Awarded products: TRIBA family



TRIBA LED SR spot mini | midi

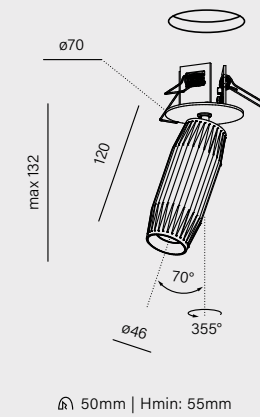

⌀ 50mm | Hmin: 55mm

cat. n°

16476-M930-WB-00-12

power:	4.5W (M) 4.5W (A)
flux:	543lm
optics:	20° (S_) 41° (W_)
CCT:	2700K (27) 3000K (30) 4000K (40)
CC driver:	(B) 500mA 8.6V
control:	ON/OFF (00) Phase-Control (PH) DALI (DA)* require driver (CC)*



* only for midi version

* Protection class, input voltage and IP rating for CC luminaires vary from above [table](#).

accessory

honeycomb



TRIBA midi GU10 SR spot

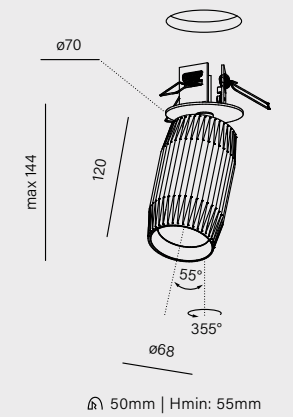

⌀ 50mm | Hmin: 55mm

cat. n°

16478-M930-WB-00-12

power:	8.5W (M) 8.5W (A)
flux:	1149lm
optics:	18° (S_) 35° (F_) 50° (W_)
CCT:	2700K (27) 3000K (30) 4000K (40)
CC driver:	(H) 250mA 34.2V
control:	ON/OFF (00) Phase-Control (PH) DALI (DA)* require driver (CC)*



cat. n°

16532-G000-00-PH-12

power:	max: 50W
control:	Phase-Control (PH)



light source not included
includes a ring in the colour of the fixture

ring finishes

only for TRIBA LED

- white -_W ○
- black -_B ●
- natural -_N ●
- burgundy -_U ●
- terracotta -_R ●
- sandy -_D ●
- taupe -_T ●
- grey -_A ●
- gold -_G ●

luminaire finishes

- white -13 ○
- black -12 ●
- brutal -85 ●
- burgundy -_86 ●
- terracotta -83 ●
- sandy -_87 ●
- taupe -82 ●
- grey -84 ●
- gold -19 ●

The brutal (-85) color variant of the luminaires can only be ordered with neutral optics (_N)

main material

aluminium

recessed
surface p. 148-152
suspended p. 282
Track p. 412-414
wall p. 470
systems p. 584



PET_spot

PET LED is a LED spotlight with a distinctive cylindrical shape that combines modern technology with varied optical parameters. It offers different power outputs and beam angles, allowing the light to be matched to the function of the interior, from focused accents to even illumination of larger areas. Its subtle form integrates well with the architecture.



recessed
 surface p. 162-164
 suspended p. 304-306
 track p. 416-420
 wall p. 472
 exterior p. 538
 systems p. 584

PET LED SR spot mini | midi | maxi

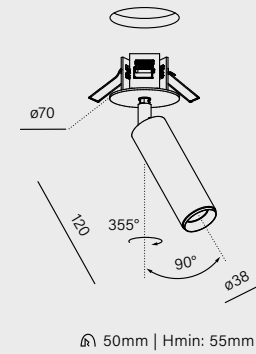

50mm | Hmin: 55mm

cat. n°

16413-M930-WB-00-12

power:	4.5W (M) 4.5W (A)
flux:	543lm
optics:	20° (S_) 41° (W_)
CCT:	2700K (27) 3000K (30) 4000K (40)
CC driver:	(B) 500mA 8.6V
control:	ON/OFF (00) Phase-Control (PH) require driver (CC)*

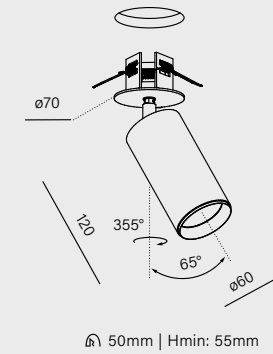

50mm | Hmin: 55mm

cat. n°

16412-M930-WB-00-12

power:	8.5W (M) 8.5W (A)
flux:	1149lm
optics:	18° (S_) 35° (F_) 50° (W_)
CCT:	2700K (27) 3000K (30) 4000K (40)
CC driver:	(H) 250mA 34.2V
control:	ON/OFF (00) Phase-Control (PH) DALI (DA) require driver (CC)*

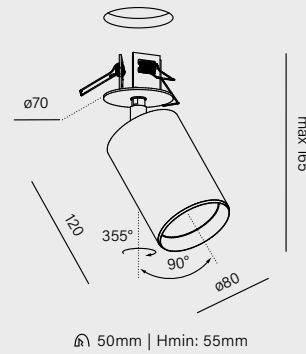

50mm | Hmin: 55mm

cat. n°

16414-M930-WB-00-12

power:	11.5W (L) 17W (M) 17W (A)
flux:	1617lm - 2261lm
optics:	19° (S_) 32° (F_) 63° (W_)
CCT:	2700K (27) 3000K (30) 4000K (40)
CC driver:	(L) 500mA 33.6V
control:	ON/OFF (00) Phase-Control (PH) DALI (DA) require driver (CC)*



* Protection class, input voltage and IP rating for CC luminaires vary from above table.

accessory

honeycomb



ring finishes

- white -_W ○
- black -_B ●
- natural -_N ●
- burgundy -_U ●
- terracotta -_R ●
- sandy -_D ●
- taupe -_T ●
- grey -_A ●
- gold -_G ●

luminaire finishes

- white -13 ○
- black -12 ●
- brutal -85 ●
- burgundy -86 ●
- terracotta -83 ●
- sandy -87 ●
- taupe -82 ●
- grey -84 ●
- gold -19 ●

The brutal (-85) color variant of the luminaires can only be ordered with neutral optics (_N)

main material
aluminium

HYPER

HYPER LED features a rotating ring that allows the beam angle to be adjusted from narrow to wide. As a result, a single spotlight can precisely highlight details as well as accentuate larger areas of a space. This solution is particularly valued in projects that require variable lighting effects and a high degree of precision.



HYPER zoom LED SR spot

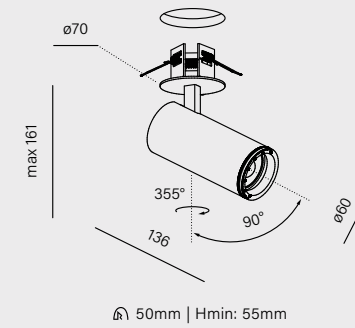

cat. n°	
16447-M930-Z3-00-12	
power:	9W (M) 9W (A)
flux:	1027lm
optics:	20-45° (Z_)
CCT:	2700K (27) 3000K (30) 4000K (40)
CC driver:	(C) 250mA 35.2V
control:	ON/OFF (00) Phase-Control (PH) DALI (DA) require driver (CC)*

* Protection class, input voltage and IP rating for CC luminaires vary from above [table](#).



luminaire finishes

- white -13
- black -12

main material

aluminium

SIRCA

SIRCA is a compact recessed luminaire with a deeply set light source that supports ease of everyday use. Available in single and double versions, it offers various wattages and beam angles. It performs well in arrangements that require precise lighting while maintaining a cohesive aesthetic.

Design: KaCeDe Pracownia Projektowa



SIRCA LED 10 | 14 | 16

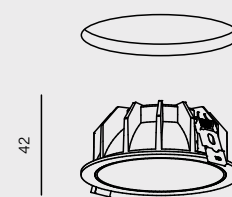

Ø105

⌀ ø95mm | Hmin: 45mm

cat. n°

37988-M930-WB-00-12

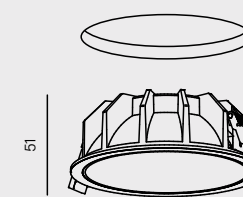
power: 8.5W (M) | 8.5W (A)**flux:** 1149lm**optics:** 59° (W_)**CCT:** 3000K (30) | 4000K (40)**CC driver:** (H) 250mA | 34.2V**control:** ON/OFF (00) | DALI (DA) | require driver (CC)*

Ø136

⌀ ø125mm | Hmin: 55mm

cat. n°

37989-M930-WB-00-12

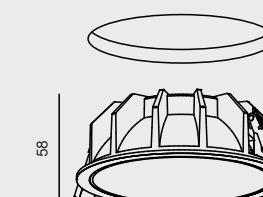
power: 12.5W (M) | 12.5W (A)**flux:** 1553lm**optics:** 53° (W_)**CCT:** 3000K (30) | 4000K (40)**CC driver:** (I) 350mA | 35.3V**control:** ON/OFF (00) | DALI (DA) | require driver (CC)*

Ø163

⌀ ø150mm | Hmin: 65mm

cat. n°

38034-M930-WB-00-12

power: 18.5W (M) | 18.5W (A)**flux:** 2120lm**optics:** 62° (W_)**CCT:** 3000K (30) | 4000K (40)**CC driver:** (J) 500mA | 36.9V**control:** ON/OFF (00) | DALI (DA) | require driver (CC)*

* Protection class, input voltage and IP rating for CC luminaires vary from above table.

optics finishes

white -_W ○

black -_B ●

luminaire finishes

white -13 ○

black -12 ●

main material

aluminium | PC



RING RIM_

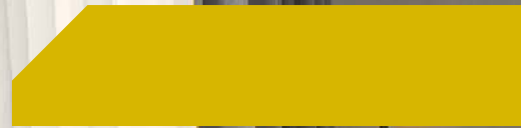

The RING rim directs light downward, providing subtle floor illumination in circulation areas. It performs well as discreet night lighting or as supplementary source of light in corridors and lobbies. Its simple form makes it both a functional and aesthetically refined element of the interior.

Design: ra 15 | Lighting design: LIGHT WORKS

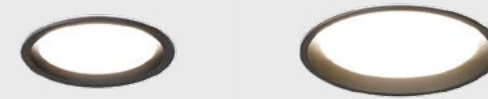

RING rim LED mini | midi

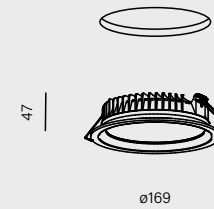

ø160mm | Hmin: 55mm

cat. n°

38031-M930-D9-00-12

power: 12.5W (M) | 12.5W (A)

flux: 1384lm

CCT: 3000K (30) | 4000K (40)

CC driver: (M) 350mA | 35.6V

control: ON/OFF (00) | Phase-Control (PH) | switchDIM (SW) | DALI (DA) | require driver (CC)*

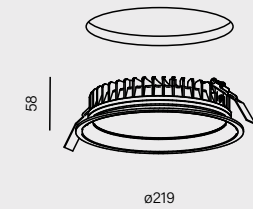

ø210mm | Hmin: 60mm

cat. n°

38030-M930-D9-00-12

power: 17W (M) | 17W (A)

flux: 2203lm

CC driver: (N) 500mA | 34.5V

* Protection class, input voltage and IP rating for CC luminaires vary from above [table](#).



luminaire finishes

- white -13 ○
- black -12 ●
- burgundy -86 ●
- terracotta -83 ●
- sandy -87 ●
- taupe -82 ●
- grey -84 ●
- gold -19 ●

main material

aluminium | PS



BIG SIZE

BIG SIZE is a lighting solution designed for large-scale spaces such as halls, conference rooms and lofts. It offers high luminous efficacy, multiple power options, two shapes and a timeless design that integrates well with a wide range of interior styles. It performs effectively wherever strong, evenly distributed light is required.

Design and Photo: ZERO32 ARCHITEKCI



BIG SIZE next round LED opal | PRO

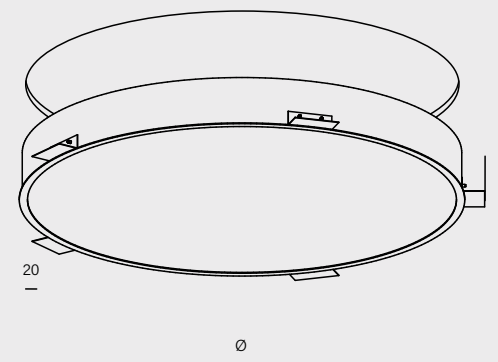

Ø mm | Hmin: 120mm

diameter	instal	cat. n°
ø675mm	ø665mm	30152-A930-D9-00-12
ø975mm	ø965mm	30153-A930-D9-00-12
ø1235mm	ø1225mm	30154-A930-D9-00-12
power:	70W - 250W (M) 23W - 130W (A)	
flux:	3263lm - 19624lm	
optics:	opal (D9) microprism (D5)	
CCT:	2700-6500K (62)* 3000K (30) 4000K (40)	
control:	ON/OFF (00) switchDIM (SW) DALI (DA) Aqsmart (DB)	



*A Tunable-White option available only for opal diffuser (D9) | *only for microprism (D5)

covers comparison

regular (opal)

PRO (microprism)

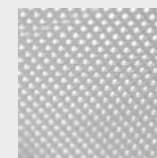
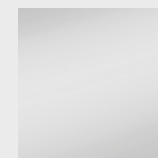

luminaire finishes

- white -13 ○
- black -12 ●

main material

aluminium | PC (opal) | PMMA (microprism)

RAFTER FAMILY

RAFTER is a modular recessed lighting system that allows various light sources to be combined within a single profile. Available in spot, linear LED, and mixed versions, it enables the creation of a cohesive lighting concept throughout the interior. High-quality optics support ease of use, while a wide range of lengths and configurations allows the solution to be matched to the room's function. Particularly suited to offices, hotels, restaurants, and residential interiors, RAFTER offers both precise accent lighting and uniform general illumination.

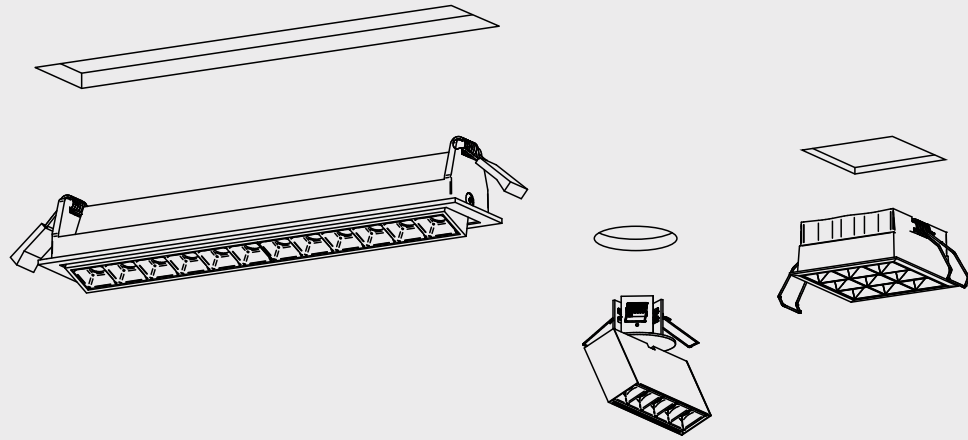

RAFTER points LED trim recessed | PET midi rift LED surface | QRLED next track



Hygge Hotel, Opole

recessed
 surface p. 206-212
 suspended p. 328-330
 track p. 430-438
 wall p. 494
 systems p. 618

RAFTER points SQ LED trim recessed

RAFTER_points trim



RAFTER points LED trim | SQ trim

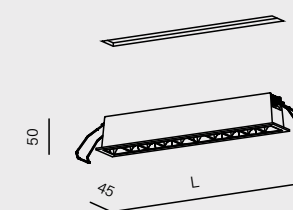

35xLmm | Hmin: 70mm

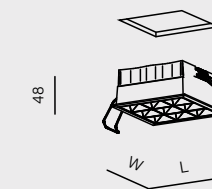

WxLmm | Hmin: 60mm

length	instal	CC driver	cat. n°	length	instal	CC driver	cat. n°
75mm	65mm	(P) 500mA 5.6V	37972-M930-WB-00-12	75x75mm	67x67mm	(Z) 500mA 11.5V	38068-M930-FB-00-12
147mm	138mm	(S) 500mA 14.2V	37973-M930-WB-00-12	105x105mm	97x97mm	(AA) 500mA 25.2V	38067-M930-FB-00-12
280mm	271mm	(T) 500mA 28.5V	37974-M930-WB-00-12				
412mm	403mm	(U) 500mA 42.7V	37975-M930-WB-00-12				
power:		1W - 10.5W (L) 2.5W - 21.5W (M) 2.5W - 21.5W (A)		2.5W - 6W (L) 5.5W - 12.5W (M) 5.5W - 12.5W (A)			
flux:		177lm - 2512lm		368lm - 1523lm			
optics:		37° (F_) 50° (W_)		32° (F_)			
CCT:		2700K (27) 3000K (30) 4000K (40)					
control:		ON/OFF (00) Phase-Control (PH)* DALI (DA)* require driver (CC)*					

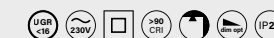

¹only for SQ trim | ²for trim from length 147mm

* Protection class, input voltage and IP rating for CC luminaires vary from above [table](#). Information about dimensions of optics placement within the luminaire are on page [642](#).

optics detail

black -_B- white -_W-



optics finishes
 white -_W ○
 black -_B ●

luminaire finishes
 white -13 ○
 black -12 ●

main material
 aluminium | PC





RAFTER points LED SR spot

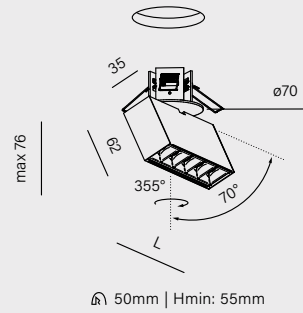

length	CC driver	cat. n°
90mm	(Q) 350mA 8.7V	16420-M930-WB-00-12
140mm	(V) 350mA 14.1V	16416-M930-WB-00-12
power:	3W - 5W (M) 3W (A)	
flux:	366lm - 602lm	
optics:	37° (F_) 50° (W_)	
CCT:	2700K (27) 3000K (30) 4000K (40)	
control:	ON/OFF (00) Phase-Control (PH) ¹ DALI (DA) require driver (CC)*	



¹ for length 140mm

* Protection class, input voltage and IP rating for CC luminaires vary from above [table](#).

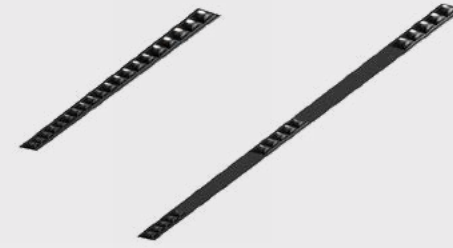

RAFTER points LED - | section

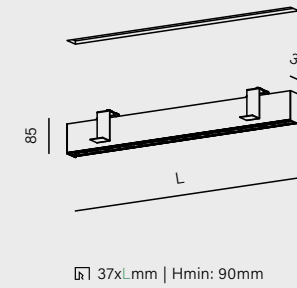

length	instal	cat. n°
271mm	273mm	30270-L930-WB-00-12
537mm	539mm	30271-M930-WB-00-12
power:	7.5W - 14.5W (L) 29.5W (M)	
flux:	889lm - 3318lm	
optics:	37° (F_) 50° (W_)	
CCT:	2700K (27) 3000K (30) 4000K (40)	
control:	ON/OFF (00)* switchDIM (SW) DALI (DA) Aqsmart (DB)	



¹ length 271mm available with ON/OFF only

Information about dimensions of optics placement within the luminaire are on page [642](#).

optics detail

black -_B- white -_W-



optics finishes

- white -_W- ○
- black -_B- ●

luminaire finishes

- white -13 ○
- black -12 ●
- brutal -85 ●

main material
aluminium | PC

RAFTER_points



RAFTER wall washer LED trim recessed

RAFTER

recessed
 surface p. 206-212
 suspended p. 328-330
 track p. 430-438
 wall p. 494
 systems p. 618

RAFTER

LIGHT INTEGRATED INTO ARCHITECTURE



RAFTER wall washer LED trim

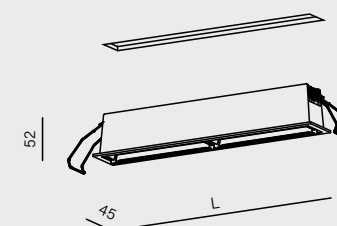

35xL mm | Hmin: 70mm

RAFTER mini points move LED

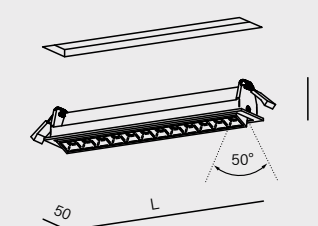

43xL mm | Hmin: 50mm

length	instal	CC driver	cat. n°	length	instal	CC driver	cat. n°
147mm	138mm	(W) 350mA 14.1V	37976-L930-R1-00-12	143mm	134mm	(AB) 500mA 17.2V	38065-M930-FB-00-12
279mm	271mm	(X) 350mA 28.2V	37977-L930-R1-00-12	255mm	247mm	(AC) 500mA 34.4V	38066-M930-FB-00-12
412mm	403mm	(Y) 350mA 42.3V	37978-L930-R1-00-12				
power:		5W - 15W (L) 5W - 15W (A)		power:		8.5W - 17W (M) 8.5W - 17W (A)	
flux:		584lm - 1752lm		flux:		778lm - 1556lm	
optics:		wall washer (R1)		optics:		37° (F ₋)	
CCT:		3000K (30) 4000K (40)		CCT:		2700K (27) 3000K (30) 4000K (40)	
control:		ON/OFF (00) DALI (DA) require driver (CC)*		control:		ON/OFF (00) Phase-Control (PH) DALI (DA) require driver (CC)*	

* Protection class, input voltage and IP rating for CC luminaires vary from above [table](#).



www.aqform.com

- optics finishes**
 only for RAFTER mini points
- white -_W ○
 - black -_B ●
- luminaire finishes**
- white -13 ○
 - black -12 ●
- main material**
 aluminium | PC

Data for standard LED product is shown for LED light source 3000K. Other variants are available on our website.

111

110

RAFTER LED recessed | RAFTER points LED recessed

GREMBOX

RAFTER

Design: K NAP Studio | Photo: Kamil „szylAIR” Szyler

recessed
 surface p. 206-212
 suspended p. 328-330
 track p. 430-438
 wall p. 494
 systems p. 618

RAFTER

LIGHT INTEGRATED INTO ARCHITECTURE



RAFTER LED

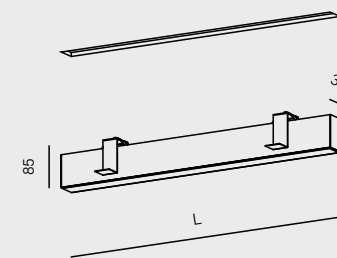

37xL mm | Hmin: 90mm

length	instal	cat. n°
570mm	572mm	30275-M930-D9-00-11
860mm	862mm	30276-M930-D9-00-11
1140mm	1142mm	30277-M930-D9-00-11
1420mm	1422mm	30278-M930-D9-00-11
1700mm	1702mm	30279-M930-D9-00-11
1980mm	1982mm	30280-M930-D9-00-11
power:	8.5W - 30W (L) 17W - 60W (M) 25W - 87W (H)	
flux:	1164lm - 10864lm	
optics:	opal diffuser (D9)	
CCT:	2700K (27) 3000K (30) 4000K (40)	
control:	ON/OFF (00) switchDIM (SW) DALI (DA) Aqsmart (DB)	



luminaire finishes

aluminium -11

main material

aluminium | PC



www.aqform.com

Data for standard LED product is shown for LED light source 3000K. Other variants are available on our website.

113

112

RAFTER mix

RAFTER mix integrates opal diffusers, adjustable spotlights and deeply embedded downlights into a single structure. As a result, one profile can perform multiple lighting functions, reducing the number of fixtures required in a project. Ideal for interiors that require varied lighting scenes.

recessed

surface p. 206-212
 suspended p. 328-330
 track p. 430-438
 wall p. 494
 systems p. 618



RAFTER mix LED 57 | 94 | 133 | 136

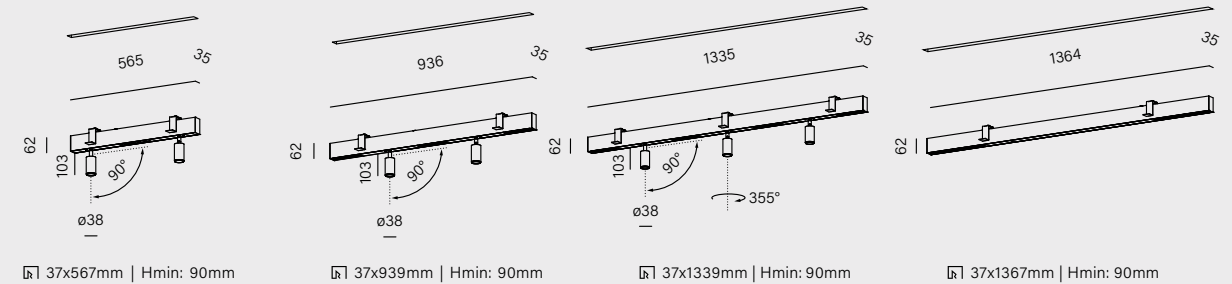

cat. n°	cat. n°	cat. n°	cat. n°
37953-M930-WB-00-12	37954-M930-WB-00-12	37955-M930-WB-00-12	37956-M930-WB-00-12
power: 16W (M)	power: 30.5W (M)	power: 42.5W (M)	power: 38W (M)
flux: 1915lm	flux: 3574lm	flux: 4947lm	flux: 4482lm
optics (points modules): 37° (F_) 50° (W_)			
CCT: 2700K (27) 3000K (30) 4000K (40)			
control: ON/OFF (00)		control: ON/OFF (00) switchDIM (SW) DALI (DA)	

optics detail

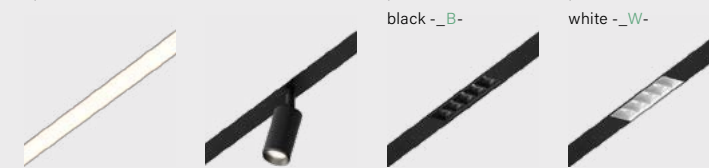

optics finishes

for points modules
 white -_W-
 black -_B-

luminaire finishes

white -13
 black -12
 brutal -85

main material

aluminium | PC (points modules) | PMMA (opal)

MIXLINE combines a linear module with a spotlight in a single form, enabling both uniform general lighting and precise accent illumination at the same time. Available in various lengths and configurations, it offers a flexible solution for offices, retail spaces, and residential interiors.

MIXLINE

recessed
 surface p. 214
 suspended p. 324
 systems p. 606



MIXLINE LED - | INV

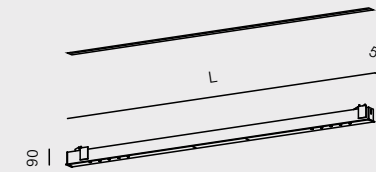

46xLmm | Hmin: 110mm

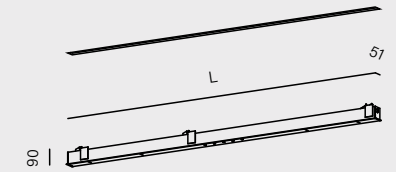

46xLmm | Hmin: 110mm

length	instal	cat. n°	length	instal	cat. n°
1600mm	1594mm	30225-M930-W3-00-12	1670mm	1664mm	30228-M930-W3-00-12
1880mm	1874mm	30226-M930-W3-00-12	1920mm	1914mm	30229-M930-W3-00-12
2160mm	2154mm	30227-M930-W3-00-12			
power:		16W - 33W (M)	power:		21W - 24.5W (M)
flux:		2064lm - 4392lm	flux:		2778lm - 3228lm
optics:		26° (F_) 54° (W_)			
CCT:		2700K (27) 3000K (30) 4000K (40)			
control:		ON/OFF (00) switchDIM (SW) DALI (DA) AQsmart (DB)			



Information about dimensions of optics placement within the luminaire are on page [642](#).



luminaire finishes

- white -13 ○
- black -12 ●
- brutal -85 ●

main material

aluminium | PMMA

LENS LINE

LENS LINE uses an advanced lens system that enables precise beam shaping. Available in wide and narrow beam versions, it allows the lighting effect to be tailored to the function of the space. Its slim form and high light quality make LENS LINE a highly versatile solution.

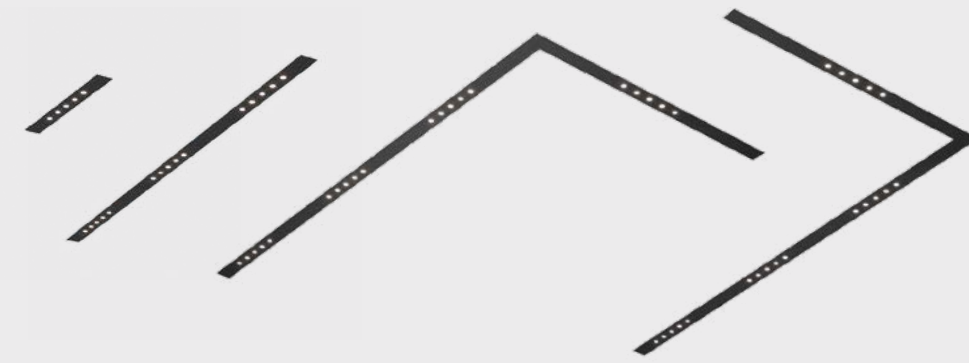

recessed
surface p. 220
suspended p. 322

LENS LINE

LIGHT INTEGRATED INTO ARCHITECTURE

LENS LINE LED - | section | 180x89 LC | 180x89 RC

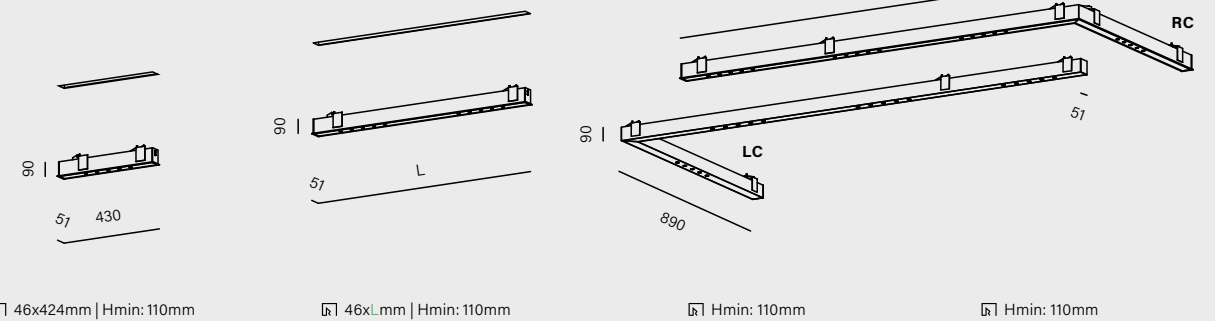

	cat. n°	length	instal	cat. n°	cat. n°	cat. n°
	30173-M930-W3-00-12	960mm	954mm	30175-M930-W3-00-12	LC 38037-M930-W3-00-12	RC 30230-M930-W3-00-12
		1490mm	1484mm	30177-M930-W3-00-12		
		2020mm	2014mm	30179-M930-W3-00-12		
power:	3.5W (L) 7.5W (M)	7W - 14.5W (L) 14.5W - 29.5W (M)		14.5W (L) 29.5W (M)		
flux:	450lm - 843lm	900lm - 3372lm		1800lm - 3372lm		
optics:	26° (F_) 54° (W_)					
CCT:	2700K (27) 3000K (30) 4000K (40)					
control:	ON/OFF (00)		ON/OFF (00) switchDIM (SW) DALI (DA) Aqsmart (DB)			

Information about dimensions of optics placement within the luminaire are on page 642.



www.aqform.com

luminaire finishes

- white -13 ○
- black -12 ●
- brutal -85 ●

main material

aluminium

Data for standard LED product is shown for LED light source 3000K. Other variants are available on our website.

119

Design: Architektura Nastazja Kropidłowska | Photo: Dariusz Jarząbek

Private apartment, Łódź

LENS LINE LED section recessed



118

SET RAW mini LED recessed | KLIVA LED suspended

SET RAW

SET RAW mini features a technical, yet subtle aesthetic. It provides well diffused lighting while maintaining a compact dimensions. Ideal for loft-style, modern, and industrial interiors, where the fixture can serve as a subtle decorative accent.

RECEPTION

recessed
suspended p. 320
wall p. 490
systems p. 610

LIGHT INTEGRATED INTO ARCHITECTURE



SET RAW mini LED

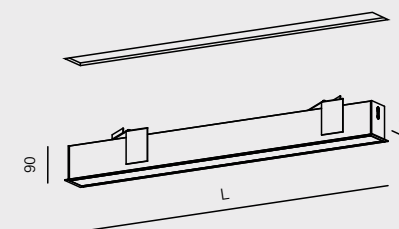

46xLmm | Hmin: 110mm

length	instal	cat. n°
581mm	574mm	30383-M930-D9-00-12
871mm	864mm	30385-M930-D9-00-12
1151mm	1144mm	30387-M930-D9-00-12
1431mm	1424mm	30389-M930-D9-00-12
1711mm	1704mm	30391-M930-D9-00-12
1991mm	1984mm	30393-M930-D9-00-12
power:		8.5W - 30W (L) 17W - 60W (M)
flux:		1164lm - 8148lm
CCT:		2700K (27) 3000K (30) 4000K (40)
control:		ON/OFF (00) switchDIM (SW) DALI (DA) Aqsmart (DB)



luminaire finishes

- white -13 ○
- black -12 ●
- brutal -85 ●

main material

aluminium | PMMA



SET TRU

SET TRU is a slim luminaire with a clean form that provides eye-friendly general lighting. It's available in both framed and frameless versions and in various lengths, it performs well in offices, retail spaces, and residential interiors, offering a cohesive visual effect and high-quality craftsmanship.

recessed
 surface p. 224
 suspended p. 338
 track p. 442
 wall p. 496
 systems p. 614

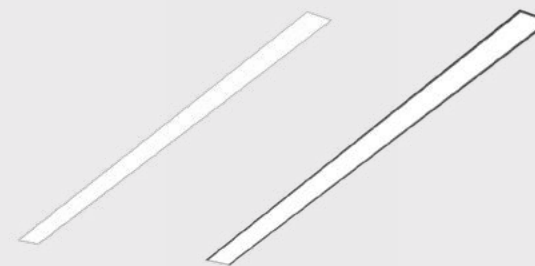

SET TRU LED opal | PRO | trim opal | trim PRO

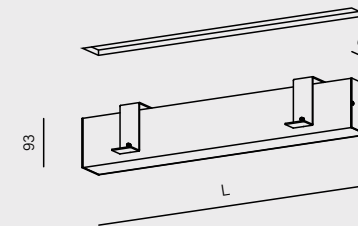

62xLmm | Hmin:110mm

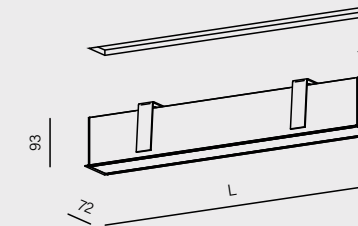

64xLmm | Hmin:130mm

length	instal	cat. n°	length	instal	cat. n°
290mm	292mm	37840-M930-D9-00-13	582mm	572mm	38019-M930-D9-00-12
570mm	572mm	37842-M930-D9-00-13	872mm	862mm	38020-M930-D9-00-12
860mm	862mm	37846-M930-D9-00-13	1152mm	1142mm	38021-M930-D9-00-12
1140mm	1142mm	37848-M930-D9-00-13	1432mm	1422mm	38022-M930-D9-00-12
1420mm	1422mm	37850-M930-D9-00-13	1712mm	1702mm	38023-M930-D9-00-12
1700mm	1702mm	37852-M930-D9-00-13			
1980mm	1982mm	37854-M930-D9-00-13			
power:		4.5W - 30W (L) 8.5W - 60W (M)	power:		8.5W - 26W (L) 17W - 51.5W (M)
flux:		582lm - 8148lm	flux:		1164lm - 6984lm
optics:		opal (D9) microprism (D5)			
CCT:		2700-6500K (62) ¹ 2700K (27) 3000K (30) 4000K (40)			
control:		ON/OFF (00) switchDIM (SW) ² DALI (DA) ² Aqsmart (DB) ²			



¹ the opal version (D9) has a Tunable-White option available from length 1140mm | ² from length 570mm and 582mm

covers comparison

regular (opal)

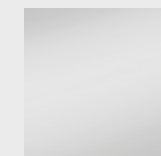

PRO (microprism)

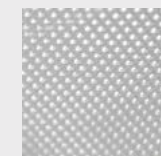

luminaire finishes

- white -13 ○
- black -12 ●⁴
- brutal -85 ●

⁴ only for SET TRU trim

main material

aluminium | PMMA



INTERIOR **SURFACE**

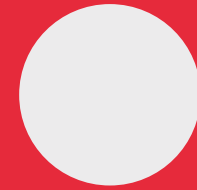
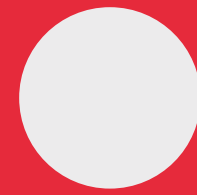

A PERFECT
BALANCE OF FORM
AND FUNCTION



INTERIOR SURFACE

PRODUCTS

**DOWNLIGHT
SNOP QRLED**



[p. 140](#)

KLIVA



[p. 144](#)

TRIBA midi



[p. 148](#)

TRIBA midi GU10



new

[p. 152](#)

PET GU10



[p. 154](#)

VYRO round 230V



[p. 172](#)

VYRO square 230V



[p. 172](#)

VYRO round move



[p. 172](#)

RAFTER points



[p. 206](#)

RAFTER points section



[p. 206](#)

LENS LINE



[p. 220](#)

LENS LINE section



[p. 220](#)

LENS LINE 180x89 RC



[p. 220](#)

LENS LINE 180x89 LC



[p. 220](#)

**SPOT
QRLED next E x1
spot**



new

[p. 132](#)

**QRLED next E x2
spot**



new

[p. 132](#)

**QRLED next
spot**



[p. 136](#)

**TRIBA midi
spot**



[p. 148](#)

**TRIBA GU10
spot**



new

[p. 152](#)

**PET
spot**



[p. 162](#)

**PET GU10
spot**



[p. 162](#)

**PET E
spot**



[p. 164](#)

**PET asymmetry
spot**



new

[p. 164](#)

**HYPER
spot**



[p. 168](#)

**RAFTER points
spot**



[p. 206](#)

RAFTER mix



[p. 212](#)

**LUMINAIRES
SNOP E27**



[p. 140](#)

KLIVA E27



[p. 144](#)

TRIBA midi E27



[p. 152](#)

CAST BALL



new

[p. 176](#)

MODERN BALL



[p. 182](#)

RING dot



[p. 186](#)

BLOS cast



[p. 194](#)

BIG SIZE next round



[p. 202](#)

RAFTER



[p. 210](#)

MIXLINE



[p. 214](#)

MIXLINE INV



[p. 214](#)

**IP-RATED
QRLED next**



new

[p. 136](#)

PET



[p. 154](#)

**MODERN BALL
simple**



[p. 178](#)

RING rim



[p. 192](#)

BLOS round



new

[p. 198](#)

SET TRU



[p. 224](#)

INTERIOR SURFACE

Every interior tells a story, and well-chosen lighting can reveal an entirely new dimension of it. Surface-mounted fixtures perform particularly well in this role, as depending on their function they can provide general illumination, act as a guiding light or serve as a subtle decorative accent.



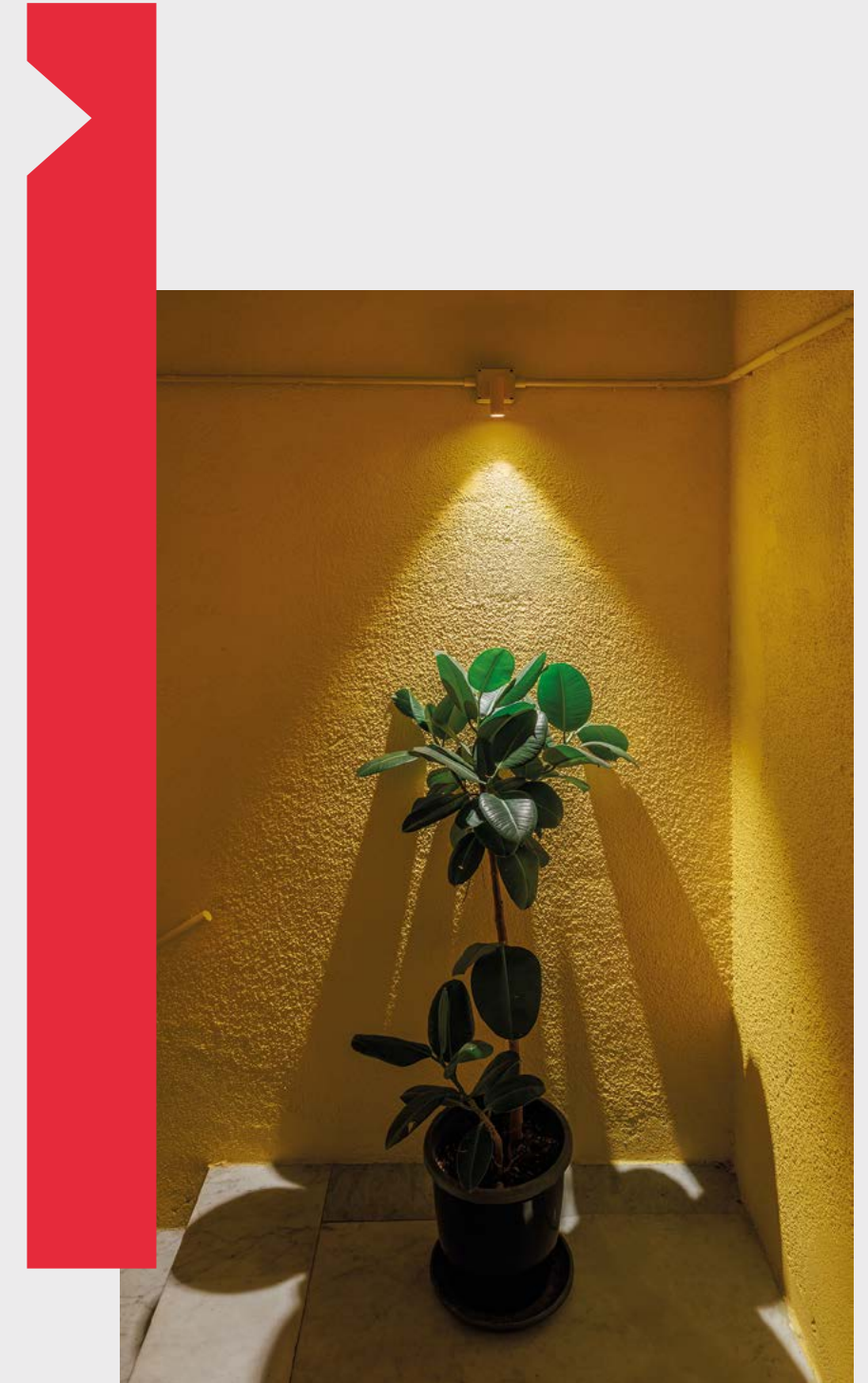
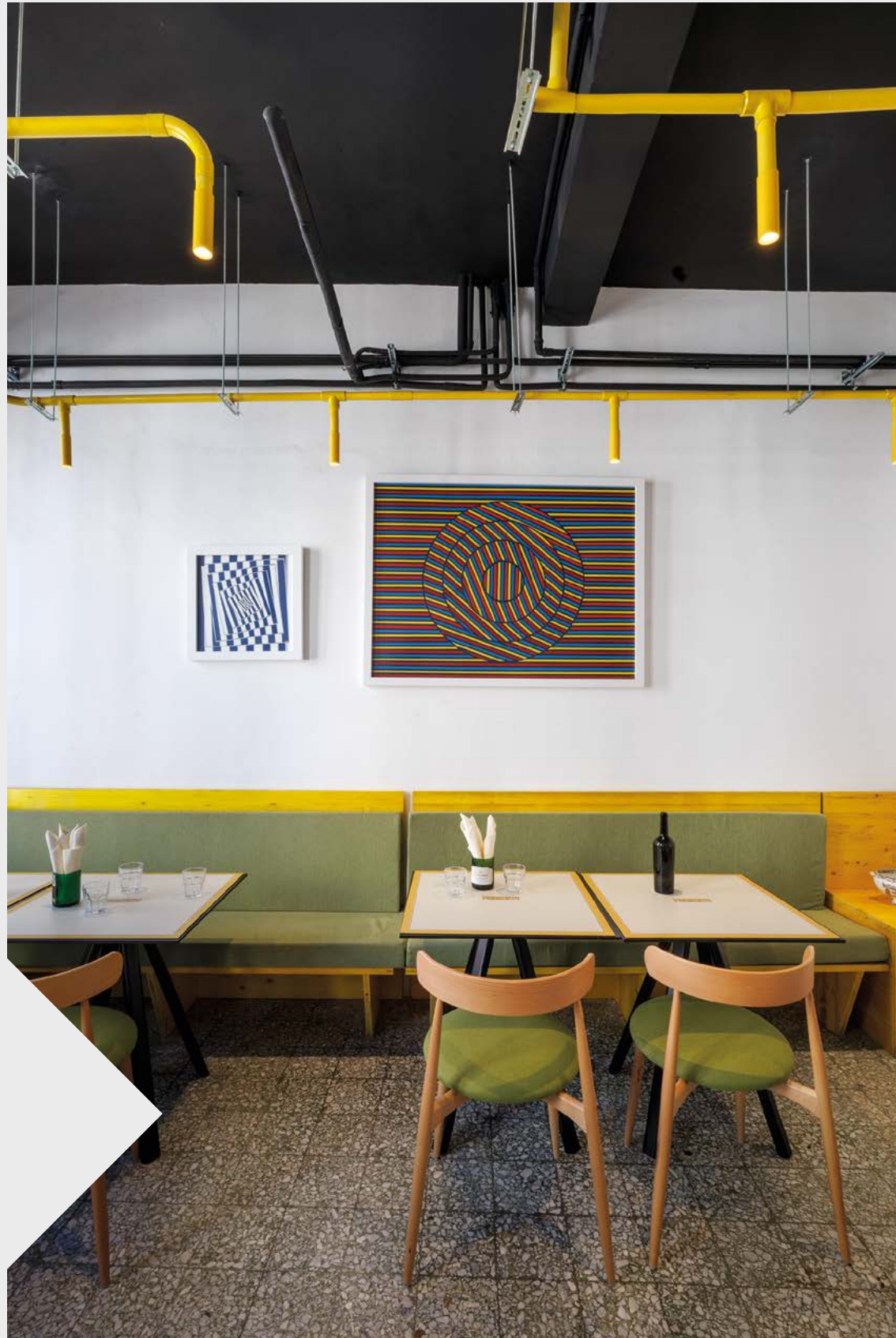

QRLED next E



NEW PRODUCT

QRLED next E spot
x1 | x2

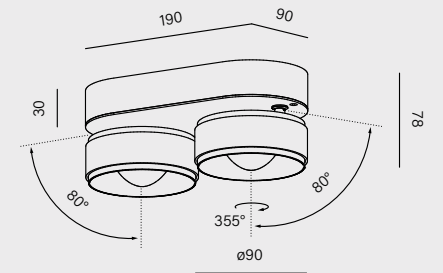
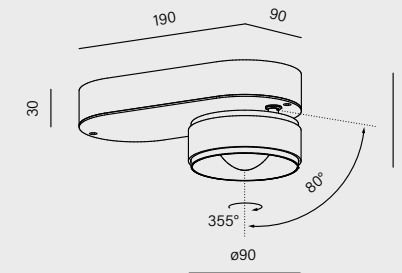

	cat. n° 16525-M930-W3-00-12	cat. n° 16526-M930-W3-00-12
power:	6W (L) 9W (M)	12W (L) 17.5W (M)
flux:	834lm - 1134lm	1668lm - 2268lm
optics:	52° (W_)	
CCT:	2700K (27) 3000K (30) 4000K (40)	
control:	ON/OFF (00) Phase-Control (PH) DALI (DA)	

luminaire finishes

- white -13 ○
- black -12 ●
- burgundy -86 ●
- terracotta -83 ●
- sandy -87 ●
- taupe -82 ●
- grey -84 ●
- gold -19 ●
- mix -06 ●

main material

aluminium | optical glass | PPE+PA





The new QRLED next E LED spot variant introduces an oval rosette and the option of one or two light modules. This solution allows lighting accents to be created with a wide range of adjustment options in areas requiring focused illumination, while maintaining coherence with other luminaires from the QRLED next family. The double version offers greater compositional freedom with just one power point.

New configuration,
more design flexibility,
the same precision of light.



The surface-mounted QRLED next is a compact, elegant fixture with high luminous output and a wide beam angle, allowing low glare to be achieved in interior spaces. Designed for dynamic, contemporary environments, it combines minimalist aesthetics with advanced LED technology, offering a perfect solution for those who value both functionality and aesthetics within a single product.

QRLED next

recessed p. 062-066
surface
 suspended p. 278
 track p. 408
 systems p. 584



QRLED next
hermetic | spot

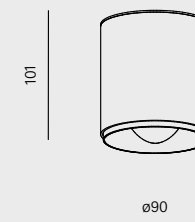

cat. n°

47063-M930-W3-00-12

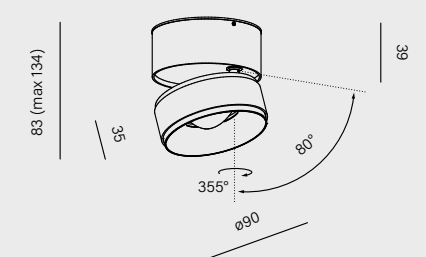

cat. n°

16487-M930-W3-00-12

power:	6W (L) 9W (M)
flux:	834lm - 1134lm
optics:	52° (W_)
CCT:	2700K (27) 3000K (30) 4000K (40)
control:	ON/OFF (00) Phase-Control (PH) DALI (DA)

luminaire finishes

- white -13 ○
- black -12 ●
- burgundy -86 ●
- terracotta -83 ●
- sandy -87 ●
- taupe -82 ●
- grey -84 ●
- gold -19 ●
- mix -06 ●

main material

aluminium | optical glass | PPE+PA



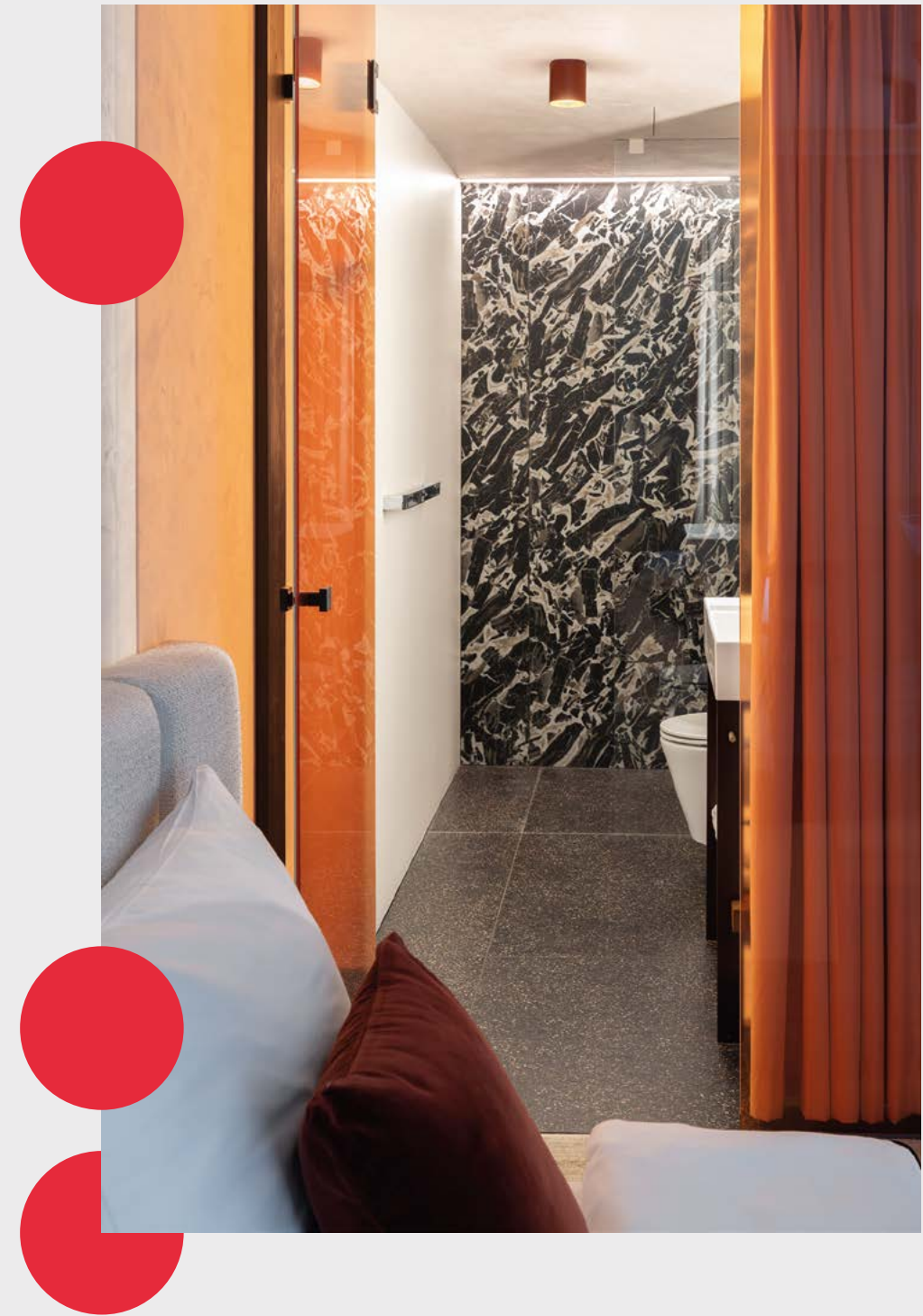

SNOP E27 surface

SNOP

Surface
suspended 2,266

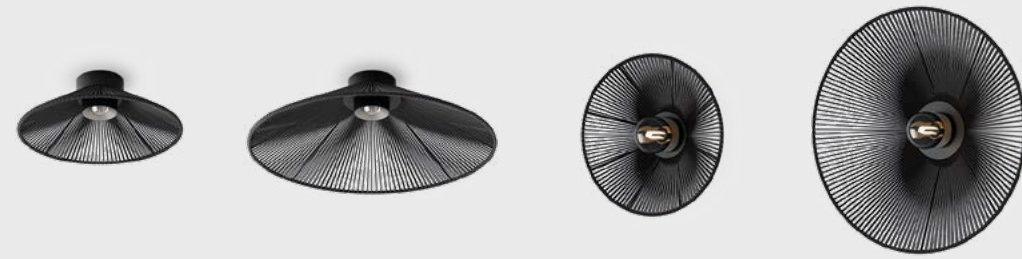

SNOP QRLED

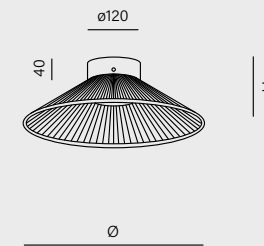

dimensions	cat. n°
ø 405mm H 140mm	47046-M930-W3-00-B2
ø 605mm H 190mm	47049-M930-W3-00-B2
power:	6W (L) 9W (M)
flux:	834lm - 1134lm
optics:	52° (W_)
CCT:	2700K (27) 3000K (30) 4000K (40)
control:	ON/OFF (00) DALI (DA)

SNOP E27

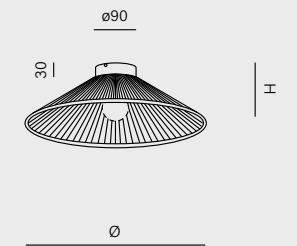

dimensions	cat. n°
ø 405mm H 136mm	47047-E000-00-PH-B2
ø 605mm H 180mm	47048-E000-00-PH-B2
power:	max: 50W
control:	Phase-Control (PH)

light source not included

luminaire finishes*

- black + terracotta shade -R2
- mix + terracotta shade -R6
- black + black shade -B2
- mix + black shade -B6
- black + khaki shade -K2
- mix + khaki shade -K6

*only for SNOP QRLED

main material

aluminium | optical glass (LED) | PPE+PA | synthetic lace | steel





DETAILS
THAT TELL
A STORY

The SNOP collection stands for precision, handcraft and the ability to combine tradition with design. Each shade is hand-wrapped with cord, making every piece truly one of a kind. Available in two versions, LED and E27, SNOP adapts flexibly to the specific needs of an interior, either by delivering functional illumination or by creating a more atmospheric effect as decorative lighting.

KLIVA

The KLIVA collection combines aesthetics harmony with functionality. Its elegant design makes it suitable for both private and commercial spaces. KLIVA adapts easily to a variety of interior styles, delivering high-quality lighting. This versatile solution captures attention with its form while remaining a distinctive element of the arrangement.



KLIVA LED

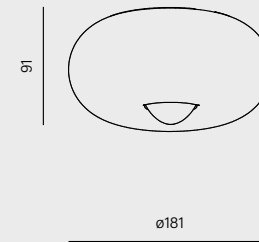

	cat. n°
	47051-M930-W3-00-12
power:	6W (L) 9W (M)
flux:	834lm - 1134lm
optics:	52° (W_)
CCT:	2700K (27) 3000K (30) 4000K (40)
control:	ON/OFF (00) Phase-Control (PH) DALI (DA)



KLIVA E27

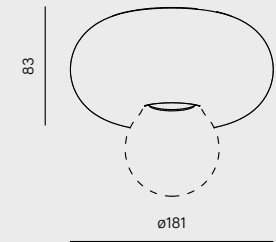

	cat. n°
	47042-E000-00-PH-12
power:	max: 50W
control:	Phase-Control (PH)



light source not included

luminaire finishes

- white -13 ○
- black -12 ●
- brutal -85 ●
- burgundy -86 ●
- terracotta -83 ●
- sandy -87 ●
- taupe -82 ●
- grey -84 ●
- gold -19 ●

main material

aluminium | steel | optical glass (LED)





TIMELESS
STYLE AND
VERSATILITY

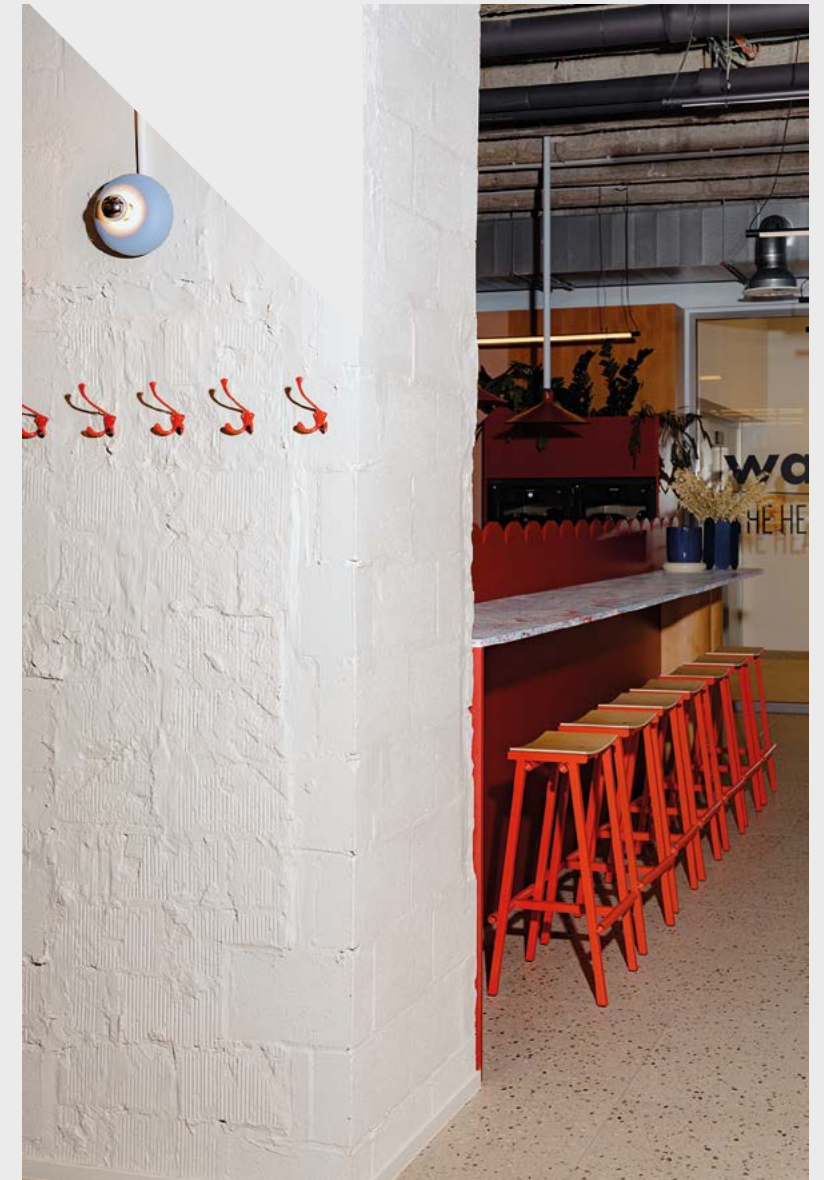



TRIBA_



recessed p. 090
surface
 suspended p. 282
 track p. 412-414
 wall p. 470
 systems p. 584



TRIBA midi LED
12 | 30 | spot

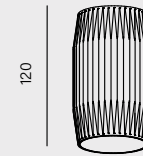

ø68

cat. n°

47040-M930-FT-00-82

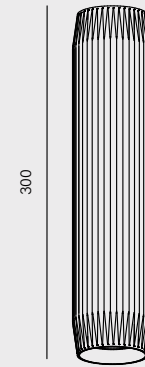

ø68

cat. n°

47041-M930-FT-00-82

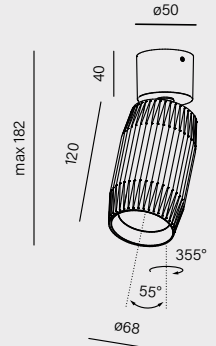

ø68

cat. n°

16477-M930-FT-00-82

power:	8.5W (M)
flux:	1149lm
optics:	18° (S_) 35° (F_) 50° (W_)
CCT:	2700K (27) 3000K (30) 4000K (40)
control:	ON/OFF (00) Phase-Control (PH) DALI (DA)*

*for height 300mm

accessory
 honeycomb



- | | |
|----------------------|---------------------------|
| ring finishes | luminaire finishes |
| white -_W ○ | white -13 ○ |
| black -_B ● | black -12 ● |
| natural -_N ● | brutal -85 ● |
| burgundy -_U ● | burgundy -86 ● |
| terracotta -_R ● | terracotta -83 ● |
| sandy -_D ● | sandy -87 ● |
| taupe -_T ● | taupe -82 ● |
| grey -_A ● | grey -84 ● |
| gold -_G ● | gold -19 ● |

The brutal (-85) color variant of the luminaires can only be ordered with neutral optics (_N)

main material
 aluminium



A perfect duo of strong technical performance and decorative design

Luminaires from the TRIBA collection combine uncompromising form with functionality enclosed in a decorative design.

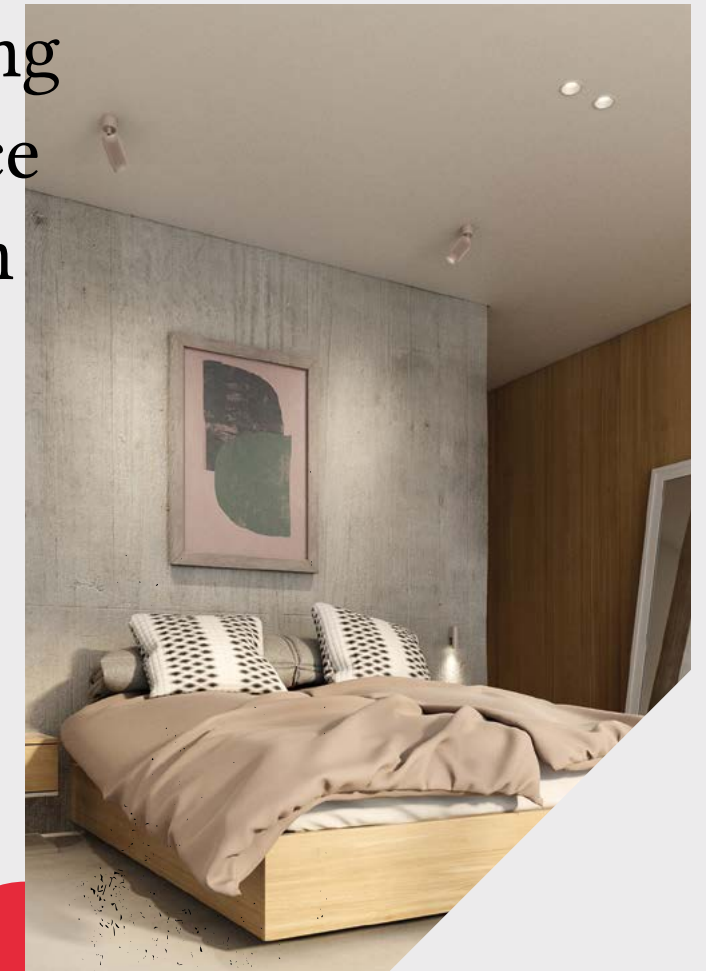

TRIBA midi E27 surface

Panorama bedrijfstgoed Zellik, Zellik

TRIBA GU10 & E27

Awarded products: TRIBA family



TRIBA

A PERFECT BALANCE OF FORM AND FUNCTION

recessed p. 090
surface
suspended p. 282
Track p. 412-414
wall p. 470
systems p. 584



TRIBA midi GU10
12 | 30 | spot

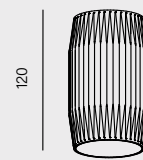

ø68

new

cat. n°

47064-G000-00-PH-82

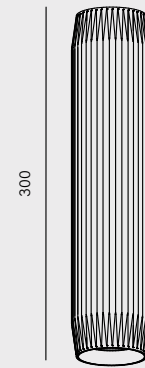

ø68

new

cat. n°

47065-G000-00-PH-82

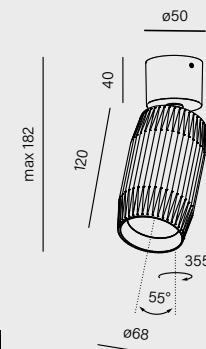

ø68

new

cat. n°

16531-G000-00-PH-82

TRIBA midi E27
9

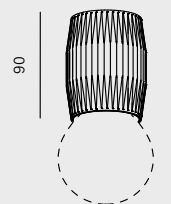

ø68

cat. n°

47039-E000-00-PH-82

power:	max: 50W		
control:	Phase-Control (PH)		

light source not included
TRIBA GU10 includes a ring in the colour of the luminaire

accessory

honeycomb



Not applicable to the E27 version



luminaire finishes

- white -13 ○
- black -12 ●
- brutal -85 ●
- burgundy -86 ●
- terracotta -83 ●
- sandy -87 ●
- taupe -82 ●
- grey -84 ●
- gold -19 ●

main material

aluminium

PET



recessed p. 092
surface
 suspended p. 304-306
 track p. 416-420
 wall p. 472
 exterior p. 538
 systems p. 584

PET

A PERFECT BALANCE OF FORM AND FUNCTION

PET LED mini | midi | maxi

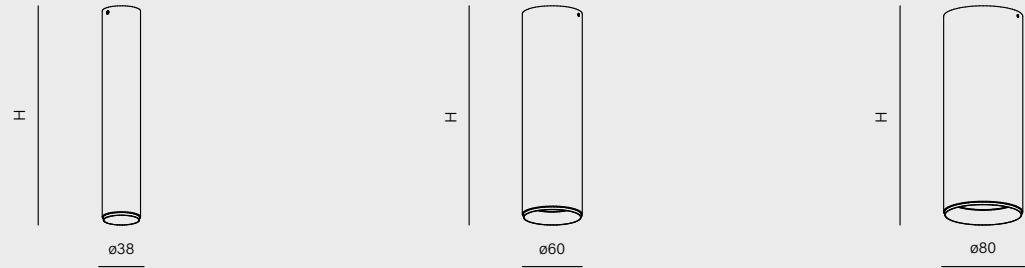

height	cat. n°	cat. n°	cat. n°
120mm	46959-M930-WB-00-12	46962-M930-WB-00-12	46965-M930-WB-00-12
200mm	46960-M930-WB-00-12	46963-M930-WB-00-12	46966-M930-WB-00-12
power:	4.5W (M)	8.5W (M)	11.5W (L) 17W (M)
flux:	543lm	1149lm	1617lm - 2261lm
optics:	20° (S_) 41° (W_)	18° (S_) 35° (F_) 50° (W_)	19° (S_) 32° (F_) 63° (W_)
CCT:	2700K (27) 3000K (30) 4000K (40)		
control:	ON/OFF (00)	ON/OFF (00) Phase-Control (PH) DALI (DA) ¹	

¹for height 200mm

PET LED hermetic mini | midi



height	cat. n°	cat. n°
122mm	47052-M930-WB-00-12	47054-M930-WB-00-12
202mm	47053-M930-WB-00-12	47055-M930-WB-00-12
power:	4.5W (M)	8.5W (M)
flux:	543lm	1149lm
optics:	20° (S_) 41° (W_)	18° (S_) 35° (F_) 50° (W_)
CCT:	2700K (27) 3000K (30) 4000K (40)	
control:	ON/OFF (00)	ON/OFF (00) Phase-Control (PH) DALI (DA) ¹

¹for height 200mm

accessory

honeycomb



Not applicable to the GU10 version



PET GU10

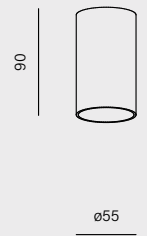

cat. n°
42311-G000-00-PH-12
power: max: 50W
control: Phase-Control (PH)

light source not included

ring finishes

only for PET LED

- white -_W ○
- black -_B ●
- natural -_N ●
- burgundy -_U ●
- terracotta -_R ●
- sandy -_D ●
- taupe -_T ●
- grey -_A ●
- gold -_G ●

luminaire finishes

- white -13 ○
- black -12 ●
- brutal -85 ●
- burgundy -86 ●
- terracotta -83 ●
- sandy -87 ●
- taupe -82 ●
- grey -84 ●
- gold -19 ●

The brutal (-85) color variant of the luminaries can only be ordered with neutral optics (_N)

main material

aluminium

PET is a comprehensive lighting solution that stands out for its power, versatility and subtle yet distinctive design. Thanks to hybrid optics and an extended shielding angle, it ensures low glare. The collection offers a broad range of applications performing effectively as general, accent or task lighting in both compact interiors and large, high-ceiling spaces.



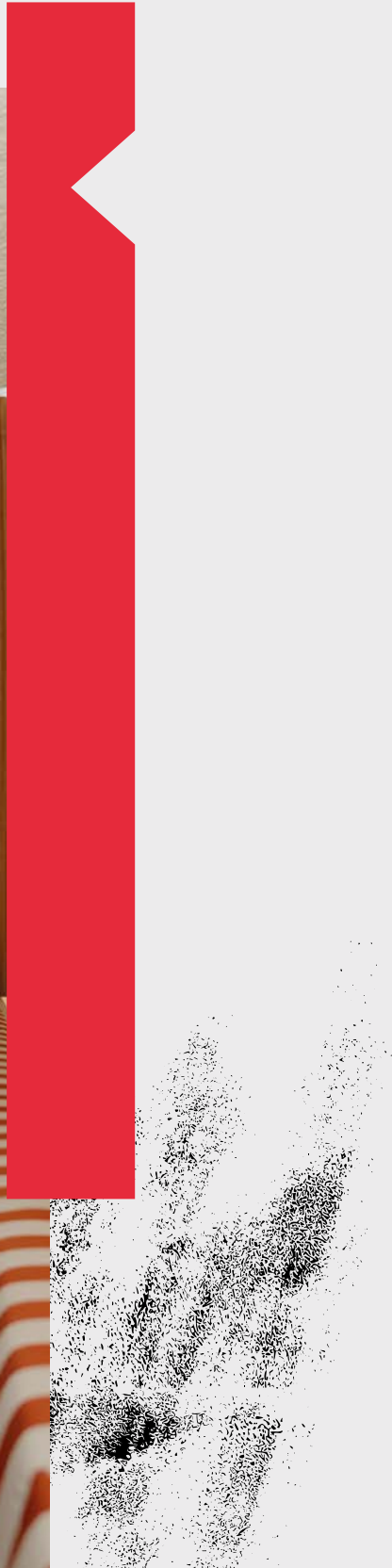
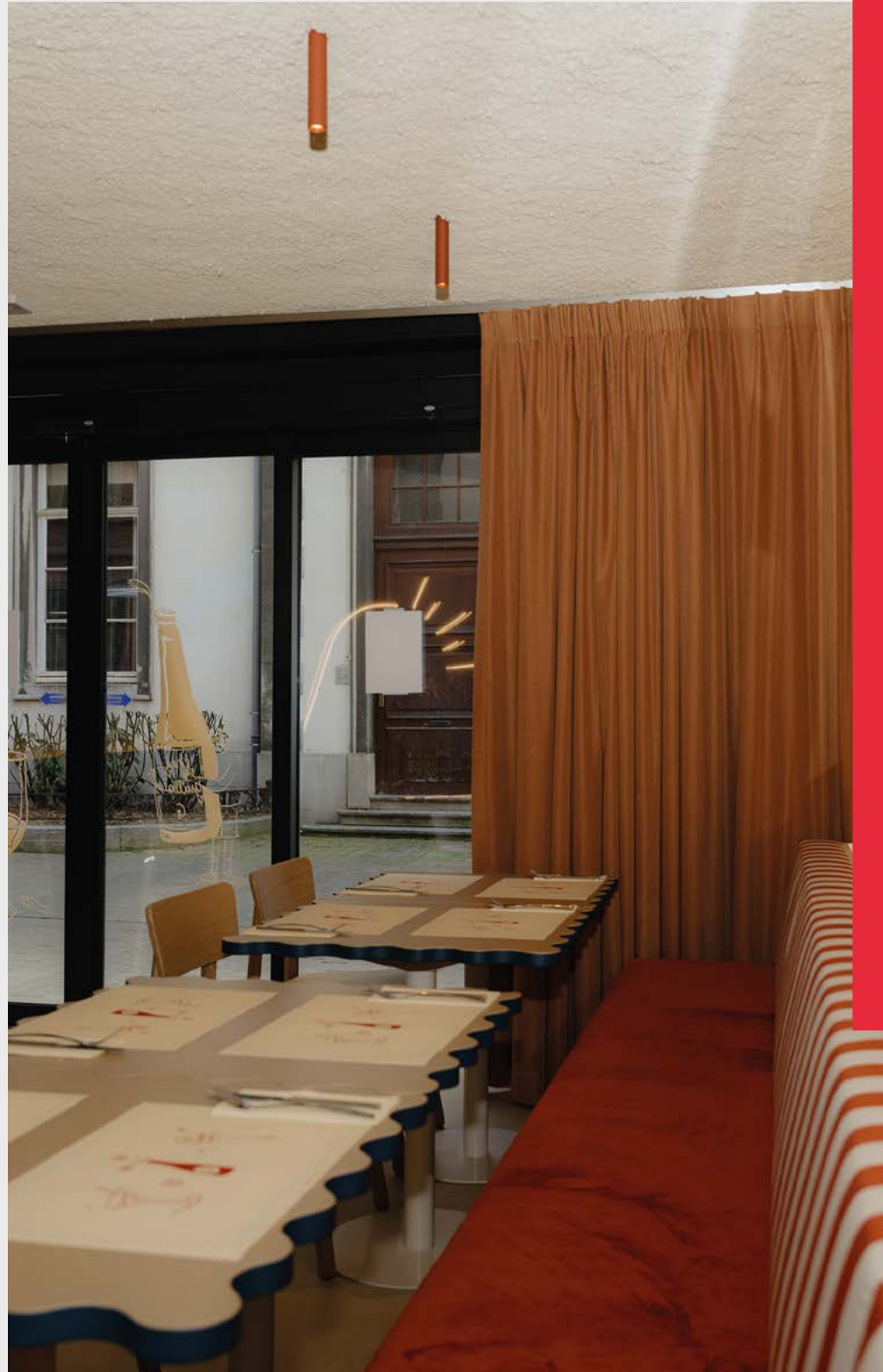



PET IS MORE
THAN JUST
A SHAPE

PET luminaires feature an extended shielding angle, multiple power options, beam angles, diameters and lengths, as well as decorative ring that allows for creative customization of the finish. Even in its mini version, PET is suitable for residential needs, while the maxi variant performs effectively in very high spaces and professional applications.





HARMONY

The minimalist design of PET enhances the product's visual appeal, while its technical performance makes it easy to illuminate any space, from private to public.



PET SPOT

PET spot is a modern lighting fixture that combines minimalist design with high functionality. It performs well in contemporary residential and commercial interiors, providing precise spot lighting. The fixture successfully merges modern aesthetics with high functionality, making PET spot a proven way to highlight selected elements, such as a favourite piece of furniture or detail, or to create a more atmospheric effect.

Awarded products: PET LED mini | PET LED midi | PET LED maxi



recessed p. 092
surface
 suspended p. 304-306
 Track p. 416-420
 wall p. 472
 exterior p. 538
 systems p. 584



PET LED spot mini | midi | maxi

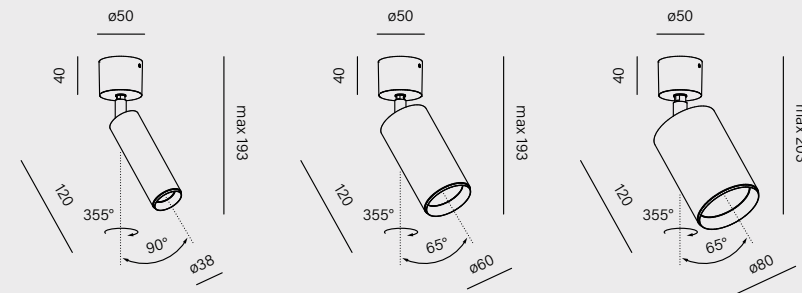

	cat. n° 16359-M930-WB-00-12	cat. n° 16363-M930-WB-00-12	cat. n° 16371-M930-WB-00-12
power:	4.5W (M)	8.5W (M)	11.5W (L) 17W (M)
flux:	543lm	1149lm	1617lm - 2261lm
optics:	20° (S_) 41° (W_)	18° (S_) 35° (F_) 50° (W_)	19° (S_) 32° (F_) 63° (W_)
CCT:	2700K (27) 3000K (30) 4000K (40)		
control:	ON/OFF (00)	ON/OFF (00) Phase-Control (PH)	

accessory

honeycomb



Not applicable to the GU10 version



PET spot GU10

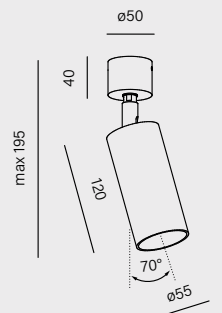

	cat. n° 10045-G000-00-PH-12
power:	max: 50W
control:	Phase-Control (PH)

light source not included

ring finishes

only for PET LED

- white -_W ○
- black -_B ●
- natural -_N ●
- burgundy -_U ●
- terracotta -_R ●
- sandy -_D ●
- taupe -_T ●
- grey -_A ●
- gold -_G ●

luminaire finishes

- white -13 ○
- black -12 ●
- brutal -85 ●
- burgundy -86 ●
- terracotta -83 ●
- sandy -87 ●
- taupe -82 ●
- grey -84 ●
- gold -19 ●

main material

aluminium

The brutal (-85) color variant of the luminaires can only be ordered with neutral optics (_N)

NEW PRODUCT



PET_ASYMMETRY

PET asymmetry LED spot
mini x2 | mini x3 | midi x2 | midi x3

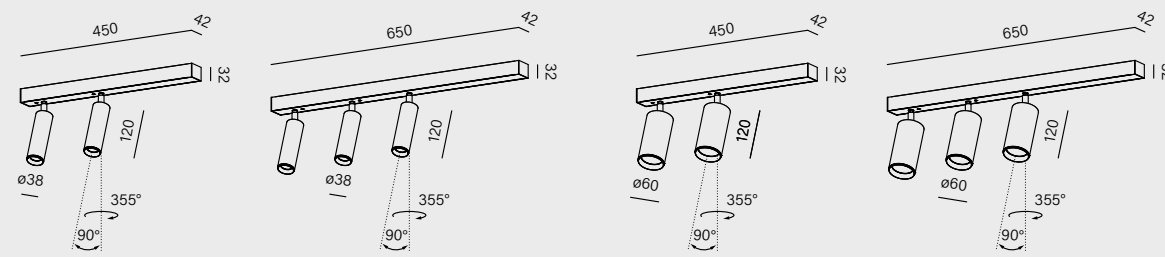

cat. n°	cat. n°	cat. n°	cat. n°
47056-M930-WB-00-12	47057-M930-WB-00-12	47058-M930-WB-00-12	47059-M930-WB-00-12
power: 8.5W (M) 13W (H)	13W (M) 19.5W (H)	17W (M)	25.5W (M)
flux: 1086lm - 1326lm	1629lm - 1993lm	2298lm	3447lm
optics: 20° (S_) 41° (W_)	18° (S_) 35° (F_) 50° (W_)		
CCT:	2700K (27) 3000K (30) 4000K (40)		
control:	ON/OFF (00) DALI (DA)		ON/OFF (00) Phase-Control (PH) DALI (DA)



PET asymmetry LED Spot is a new variant of the well-known PET spotlights, featuring an elongated, oval ceiling plate. Two or three light modules are arranged asymmetrically, grouped on one side of the canopy. This design allows several spotlights to be installed at a single mounting point while maintaining a clear and organised appearance across multiple light sources.

SPOT



& E

PET E LED spot
mini x1 | mini x2 | midi x1 | midi x2

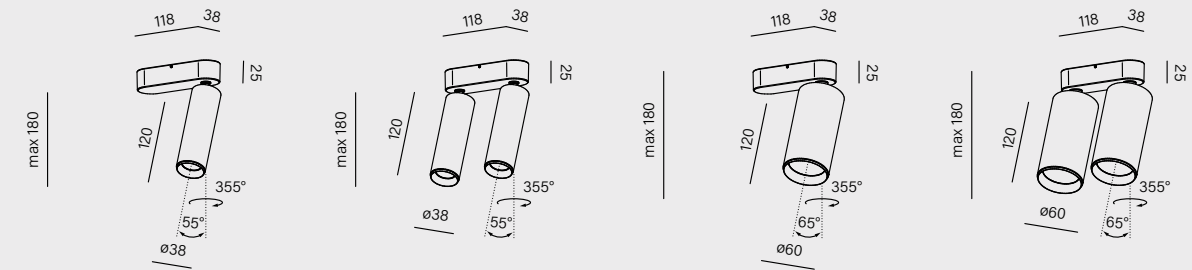

cat. n°	cat. n°	cat. n°	cat. n°
16469-M930-WB-00-12	16470-M930-WB-00-12	16467-M930-WB-00-12	16468-M930-WB-00-12
power: 4.5W (M)	8.5W (M)	8.5W (M)	17W (M)
flux: 543lm	1086lm	1149lm	2298lm
optics:	20° (S_) 41° (W_)		18° (S_) 35° (F_) 50° (W_)
CCT:	2700K (27) 3000K (30) 4000K (40)		
control:	ON/OFF (00)		ON/OFF (00) Phase-Control (PH)



- | ring finishes | luminaire finishes |
|------------------|--------------------|
| white -_W ○ | white -13 ○ |
| black -_B ● | black -12 ● |
| natural -_N ● | brutal -85 ● |
| burgundy -_U ● | burgundy -86 ● |
| terracotta -_R ● | terracotta -83 ● |
| sandy -_D ● | sandy -87 ● |
| taupe -_T ● | taupe -82 ● |
| grey -_A ● | grey -84 ● |
| gold -_G ● | gold -19 ● |

accessory
honeycomb



The brutal (-85) color variant of the luminaires can only be ordered with neutral optics (_N)

main material
aluminium

recessed p. 092
surface
suspended p. 304-306
Track p. 416-420
wall p. 472
exterior p. 538
systems p. 584

PET

A PERFECT BALANCE OF FORM AND FUNCTION

PET midi x2 asymmetry LED spot



PET mini x3 asymmetry LED spot

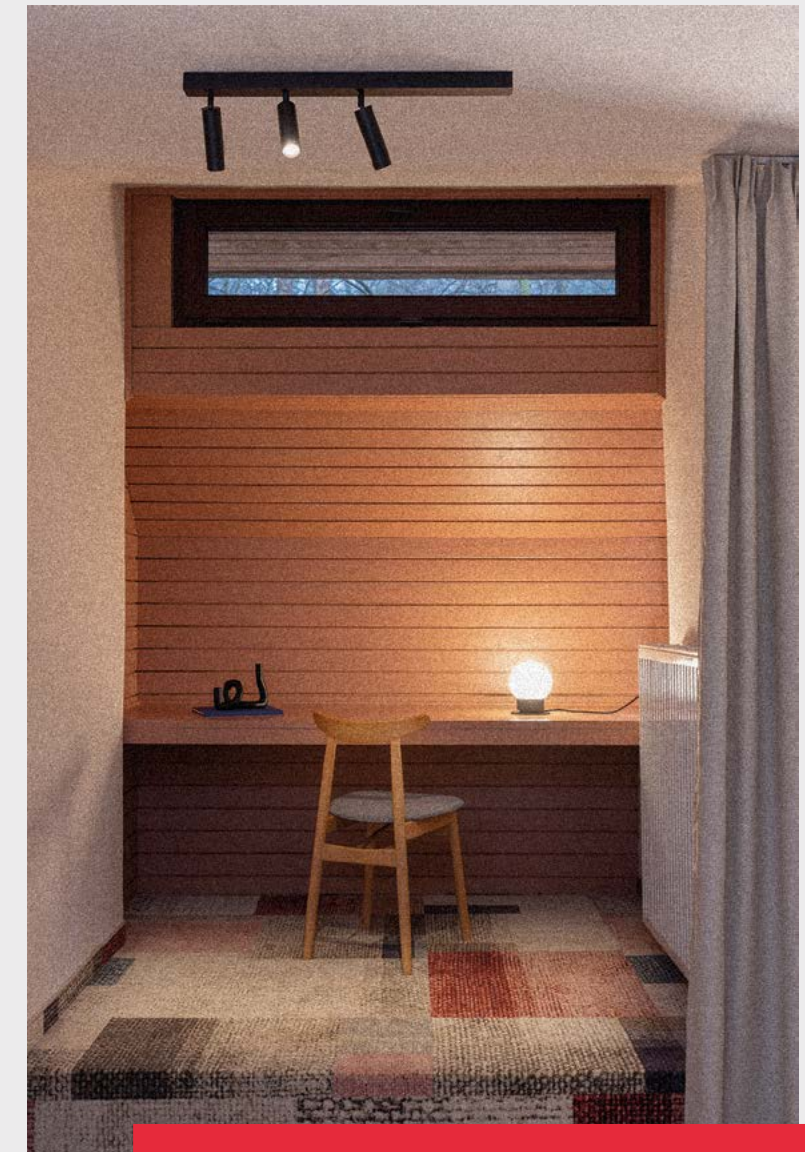

Multiple spotlights,
one power point – a clear
and organised layout

HYPER_spot

HYPER zoom is designed for those seeking a high-performance fixture with an adjustable beam angle. It is defined by a distinctive form and strong light output, combining modern appearance with technical precision.



HYPER zoom LED spot

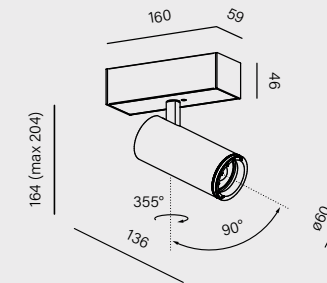

cat. n°

16448-M930-Z3-00-12

power:	9W (M)
flux:	1027lm
optics:	20-45° (Z_)
CCT:	2700K (27) 3000K (30) 4000K (40)
control:	ON/OFF (00)



luminaire finishes

- white -13 ○
- black -12 ●

main material

aluminium



VYRO

VYRO offers the option to independently select the colour of the optics and the body, allowing refined and unique colour combinations. This approach opens up additional design possibilities: the luminaire can become a bold accent or subtly reference the colours and materials used in the interior, offering greater freedom when aligning with the project concept.

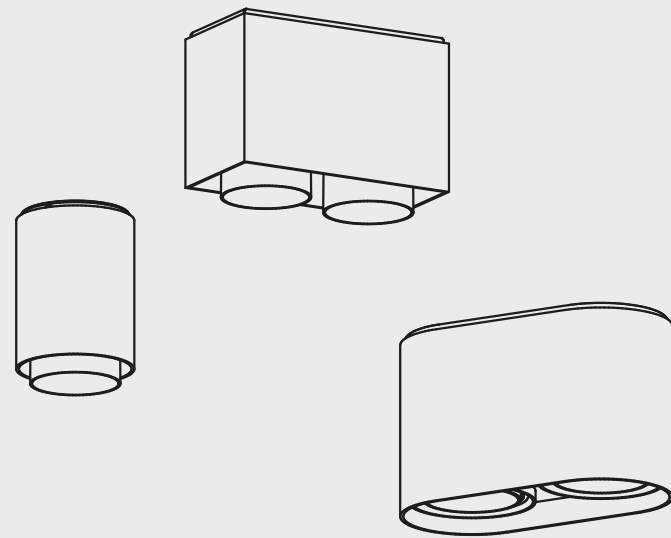

VYRO square LED 230V surface

VYRO



VYRO round move LED
x1 | x2

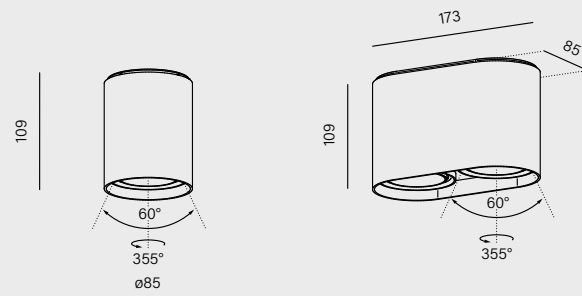

	cat. n°	cat. n°
	47037-M930-FB-PH-12	47038-M930-FB-PH-12
power:	6W (M)	11.5W (M)
flux:	794lm	1588lm
optics:	36° (F_) 59° (W_)	
CCT:	2700K (27) 3000K (30)	
control:	Phase-Control (PH)	Phase-Control (PH) DALI (DA)



VYRO round LED 230V
x1 | x2

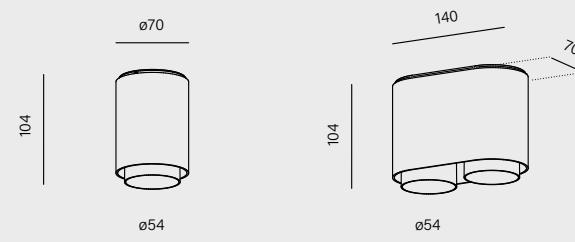

	cat. n°	cat. n°	cat. n°	cat. n°
	47033-M930-FB-PH-12	47034-M930-FB-PH-12	47035-M930-FB-PH-12	47036-M930-FB-PH-12
power:	8W (M)	16W (M)	8W (M)	16W (M)
flux:	680lm	1360lm	680lm	1360lm
optics:	27° (F_)			
CCT:	2700K (27) 3000K (30) 4000K (40)			
control:	Phase-Control (PH)			

VYRO square LED 230V
x1 | x2

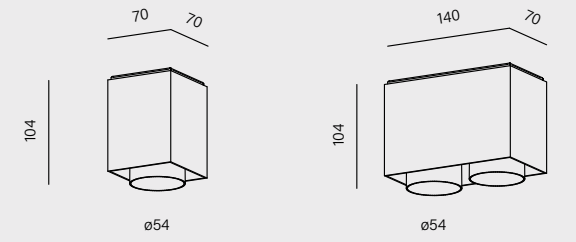

The VYRO luminaire family is distinguished by a wide range of available finishes, two beam angle options in the adjustable version. Good technical performance, easy installation, and multiple configurations, including single or double light sources and rounded or square shapes, make it a well-suited solution for homes and apartments.



- ring finishes**
- white -_W ○
- black -_B ●
- burgundy -_U ●
- terracotta -_R ●
- sandy -_D ●
- taupe -_T ●
- grey -_A ●
- gold -_G ●
- luminaire finishes**
- white -13 ○
- black -12 ●
- burgundy -86 ●
- terracotta -83 ●
- sandy -87 ●
- taupe -82 ●
- grey -84 ●
- gold -19 ●

main material
aluminium | steel

Surface

VYRO x2 round LED 230V surface



VYRO x1 round LED 230V surface | TRIBA LED suspended

STYLISH LIGHTING FOR PRIVATE SPACES

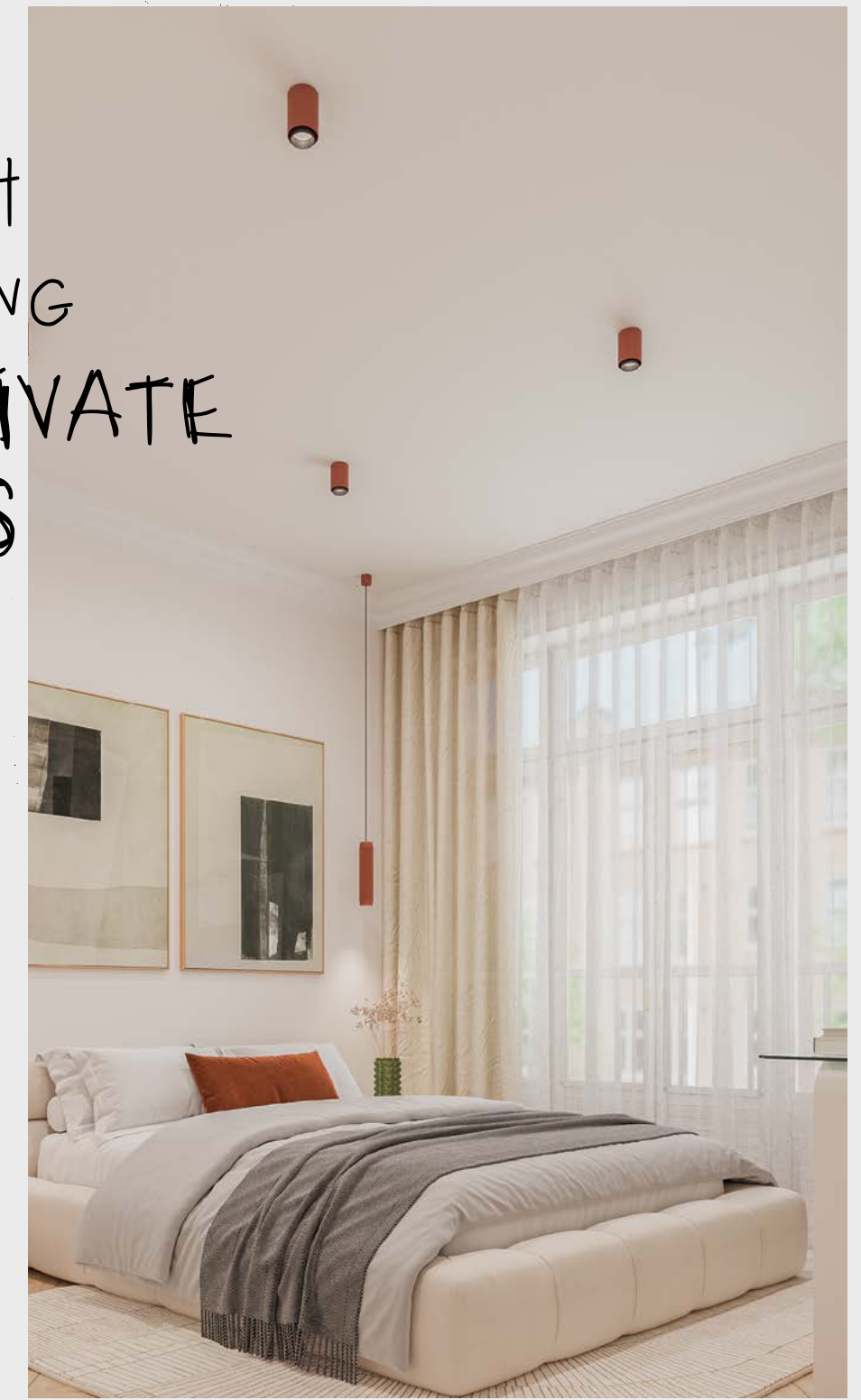

CAST BALL

CAST BALL LED combines the spherical form known from MODERN BALL with the cast base characteristic of BLOS cast. The glass shade partially merges with the gypsum base, giving the luminaire a bold, decorative character. It provides uniform light distribution and allows the shade and base to be freely combined in mini and midi sizes, creating a variety of compositions.



CAST BALL LED mini | midi

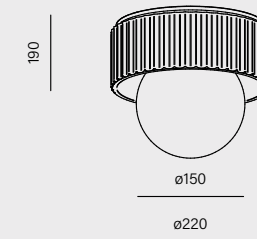
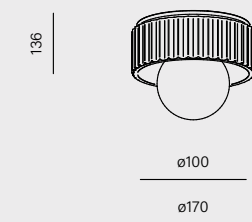

	cat. n°	cat. n°
	47060-M930-DX-00-12	47061-M930-DY-00-12
power:	4W (L) 6W (M)	6W (L) 9W (M)
flux:	580lm - 794lm	834lm - 1134lm
CCT:	2700K (27) 3000K (30) 4000K (40)	
control:	ON/OFF (00)	



luminaire finishes

- white -13
- black -12
- burgundy -86
- terracotta -83
- sandy -87
- taupe -82
- grey -84
- gold -19

main material

aluminium | glass | synthetic gipsum



MODERN BALL simple



MODERN BALL simple combines timeless design with functionality. The milky glass globe, an icon of design, conceals impressive technical performance, delivering up to 100lm/W. MODERN BALL simple is a refined solution for general lighting, while its softly diffused, eye-friendly light performs well in both private and public spaces.



Design: Projekt Praga

surface
suspended p. 296-298
Track p. 448
upright p. 516
systems p. 584



MODERN BALL simple PW LED hermetic mini SR | midi SR | mini | midi | maxi

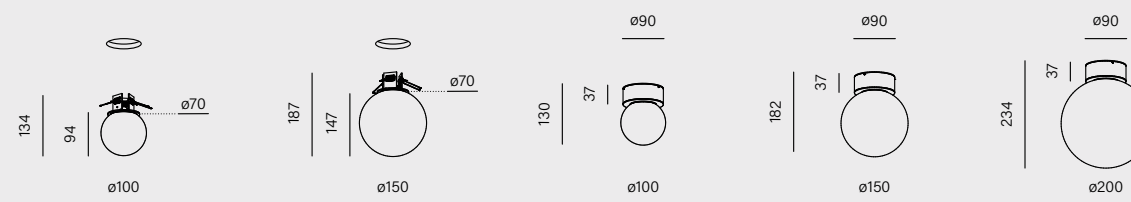

	cat. n°	cat. n°	cat. n°	cat. n°	cat. n°
	47015-M930-PW-00-12	47001-M930-PW-00-12	47016-M930-PW-00-12	47000-M930-PW-00-12	47014-M930-PW-00-12
power:	4W (L) 6W (M) 6W (A)	6W (L) 9W (M) 9W (A)	4W (L) 6W (M)	6W (L) 9W (M)	8W (L) 11.5W (M)
flux:	580lm - 794lm	834lm - 1134lm	580lm - 794lm	834lm - 1134lm	1173lm - 1617lm
CCT:	2700K (27) 3000K (30) 4000K (40)				
CC driver:	(D) 350mA 16.7V	(G) 350mA 25.1V	-		
control:	ON/OFF (00) Phase-Control (PH) DALI (DA) require driver (CC)*		ON/OFF (00)		

*Protection class, input voltage and IP rating for CC luminaires vary from above table.

luminaire finishes

- white -13
- black -12
- burgundy -86
- terracotta -83
- sandy -87
- taupe -82
- grey -84
- gold -19

main material

aluminium | glass



MODERN BALL simple maxi PW LED hermetic surface

Private apartment, Warszawa



Design: Chruściany Studio

BRIGHTLY



THIN TUBE central LED suspended | MODERN BALL simple midi PW LED hermetic surface

Syrena Irena, Warszawa

Design: Projekt Praga

MODERN BALL



MODERN BALL PW LED x1 | x2 | x3

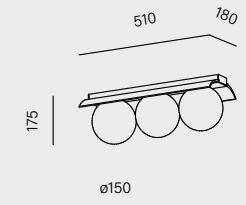
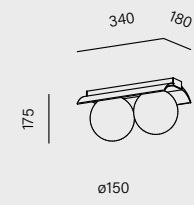
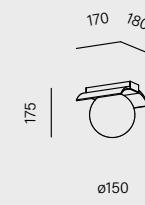

	cat. n°	cat. n°	cat. n°
	46970-M930-PW-00-12	46971-M930-PW-00-12	46972-M930-PW-00-12
power:	6W (L) 8.5W (M)	11.5W (L) 17W (M)	17.5W (L) 26W (M)
flux:	794lm - 1097lm	1588lm - 2194lm	2382lm - 3291lm
CCT:	2700K (27) 3000K (30) 4000K (40)		
control:	ON/OFF (00) DALI (DA)		



Surface
suspended 2, 296

luminaire finishes

- white -13 ○
- black -12 ●
- burgundy -86 ●
- terracotta -83 ●
- sandy -87 ●
- taupe -82 ●
- grey -84 ●
- gold -19 ●

main material

aluminium | glass



Minimalist yet **distinctive design** remains a timeless trend in interior design, as demonstrated by the MODERN BALL collection. It combines a decorative function with high efficiency.



RING DOT

RING DOT is a luminaire that provides general lighting, combining the advantages of technical performance with a sleek, geometric shape that adds visual lightness. Softly diffused, reflected light illuminates the space without unpleasant glare. As a result, RING DOT performs well in both private and public interiors, adding character through its aesthetic presence.



RING dot LED midi | maxi

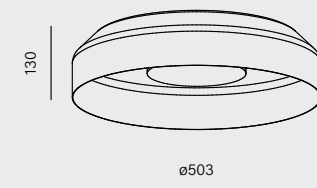
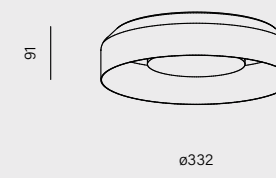

	cat. n°	cat. n°
	47028-M930-DW-PH-12	47027-M930-DW-PH-12
power:	14.5W (M)	25W (M)
flux:	2168lm ¹	3833lm ¹
CCT:	2700K (27) 3000K (30) 4000K (40)	
control:	Phase-Control (PH)	Phase-Control (PH) DALI (DA)

¹ Luminaires with a colored interior finish emit a lower luminous flux and are intended for decorative use.

- inner finishes**
- white -_W ○
- grey -_A ●
- terracotta -_R ●
- sandy -_D ●
- taupe -_T ●
- gold -_G ●
- luminaire finishes**
- white -13 ○
- black -12 ●
- burgundy -86 ●
- terracotta -83 ●
- sandy -87 ●
- taupe -82 ●
- grey -84 ●
- gold -19 ●

main material
aluminium | steel | PC



The signature feature of RING DOT is its inner ring





Before the light reaches the room,
it reflects off the interior of the fixture,
creating a particularly eye-pleasing glow.

RING_RIM

RING RIM is a lighting solution designed to meet the needs of circulation areas. Despite its compact size, it evenly illuminates the entire space, softly highlighting both walls and flooring. RING RIM performs well in both private and public interiors.

Design: IN-ARCHITEKTURA I WNEŹRZA

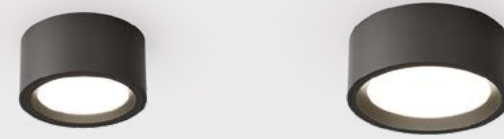

RING rim LED mini | midi

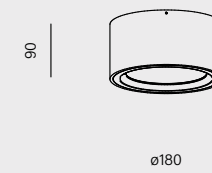

cat. n°

47026-M930-D9-00-12

power: 12.5W (M)
flux: 1384lm

CCT: 3000K (30) | 4000K (40)

control: ON/OFF (00) | Phase-Control (PH) | switchDIM (SW) | DALI (DA)

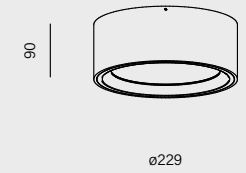

cat. n°

47020-M930-D9-00-12

power: 17W (M)
flux: 2203lm

luminaire finishes

- white -13
- black -12
- burgundy -86
- terracotta -83
- sandy -87
- taupe -82
- grey -84
- gold -19

main material

aluminium | PS





BLOS cast



BLOS cast C LED
33 | 40 | 55

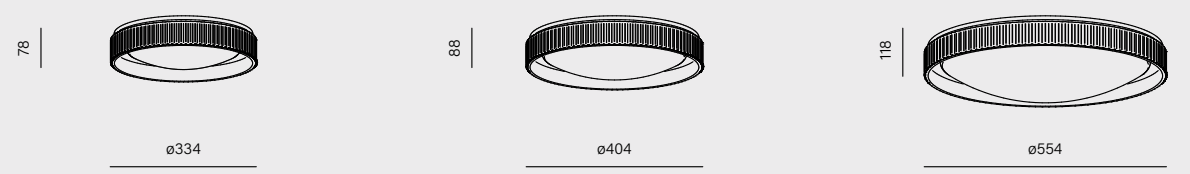

	cat. n°	cat. n°	cat. n°
	47043-M930-D9-00-12	47044-M930-D9-00-12	47045-M930-D9-00-12
power:	10.5W (M)	18W (M)	29.5W (M)
flux:	1326lm	2218lm	3716lm
CCT:	2700K (27) 3000K (30) 4000K (40)		
control:	ON/OFF (00) DALI (DA)		

luminaire finishes

- white -13 ○
- black -12 ●
- burgundy -86 ●
- terracotta -83 ●
- sandy -87 ●
- taupe -82 ●

main material

synthetic gypsum | steel | PMMA





BLOS cast is a perfect example of how the interplay of materials, shapes, and light can give a space a distinctive character.

BLOS cast is a luminaire with a timeless form that also aligns with contemporary design trends. Made from synthetic gypsum, it features a distinctive porous texture that brings lightness and character to interiors. Available in several sizes and four colour options, BLOS cast looks stunning both on its own and in grouped lighting arrangements.



BLOS_round

BLOS round combines strong technical parameters and rugged construction while maintaining an elegant character. It performs well as general lighting. The collection features an elevated ingress protection rating as well as high impact resistance, making it a proven solution for both residential and public spaces.



BLOS round distance LED hermetic

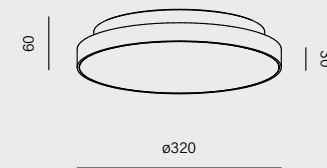

cat. n°

47019-M930-D9-00-12

power:	11.5W (L) 23W (M)
flux:	1725lm - 3268lm
CCT:	2700K (27) 3000K (30) 4000K (40)
control:	ON/OFF (00) Phase-Control (PH) ¹ DALI (DA) Aqsmart (DB) Occupation Sensor (OS) ²



¹ available only for L version

² Control system OS integrates a microwave motion sensor for automatic presence detection. It supports tri-level dimming, corridor function, and configurable parameters such as detection area, hold-time, daylight threshold, and standby dimming level.

accessory

81300 - BLOS round PRO diffuser set



new



luminaire finishes

- white -13
- black -12
- burgundy -86
- terracotta -83
- sandy -87
- taupe -82
- grey -84
- gold -19

main material

PC



BLOS round performs well as general lighting in bathrooms, small living rooms, circulation areas and outdoor spaces.



BIG SIZE next round LED PRO surface

Modern house with character, Zielona Góra

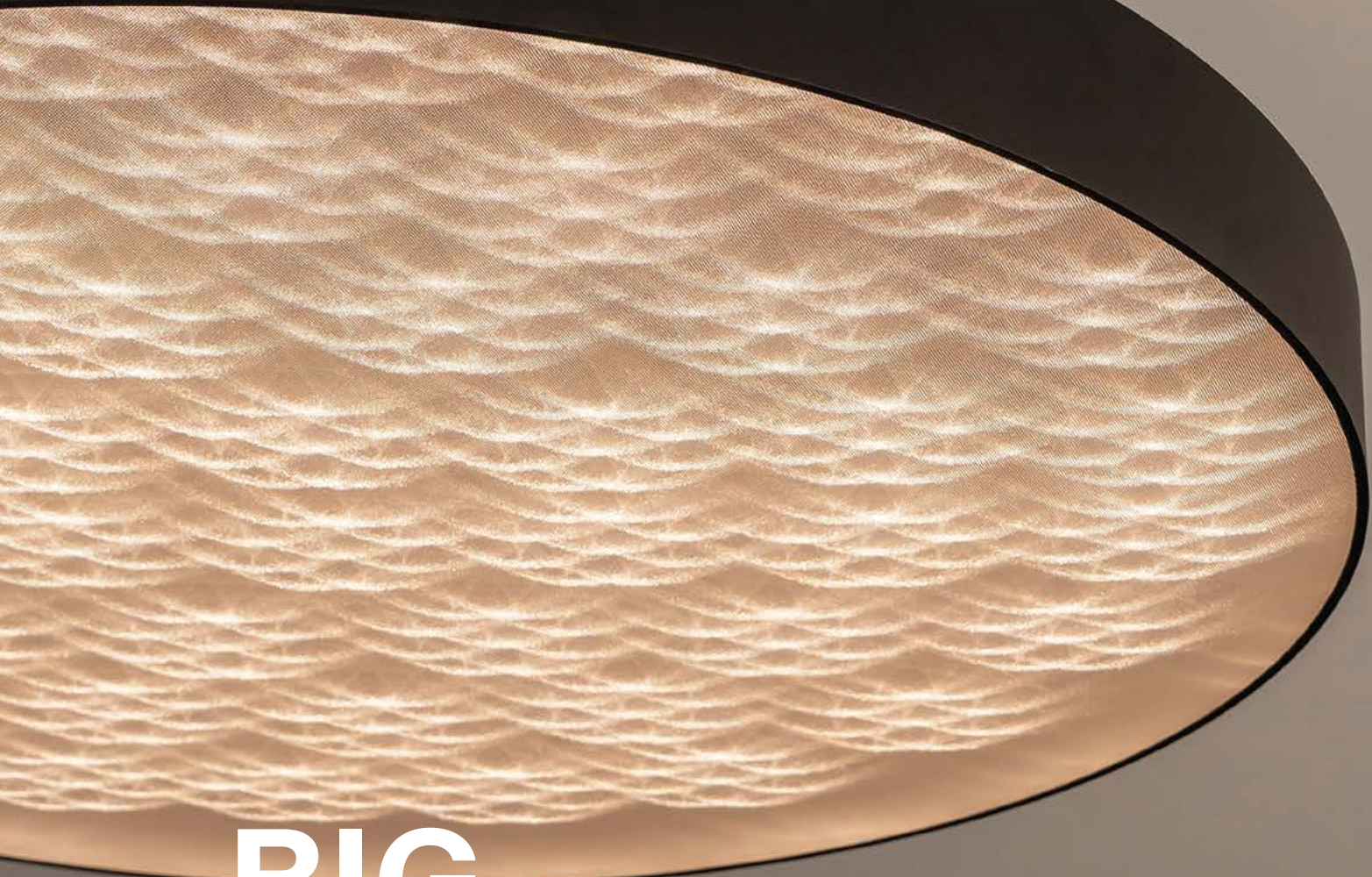

BIG SIZE_round

The photos show versions with the PRO diffuser. The opal version creates a smooth diffuser effect.

Design: FANAJLO Home Design Decor | Photo: KRZYSZTOF STRAŻYŃSKI

recessed p. 100
surface
suspended p. 314

BIG SIZE

A PERFECT BALANCE OF FORM AND FUNCTION



BIG SIZE next round LED opal | PRO

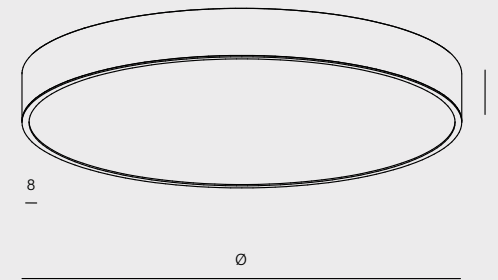

diameter	cat. n°
ø 450mm	46976-A930-D9-00-12
ø 660mm	40237-A930-D9-00-12
ø 960mm	40238-A930-D9-00-12
ø 1220mm	40239-A930-D9-00-12
power:	30W - 250W (M) 10.5W - 130W (A)
flux:	1506lm - 19624lm
optics:	opal (D9) microprism (D5)
CCT:	2700-6500K (62)* 3000K (30) 4000K (40)
control:	ON/OFF (00) switchDIM (SW) DALI (DA) AQsmart (DB)



*A Tunable-White option available only for opal diffuser (D9) | *only for microprism (D5)

covers comparison

regular (opal)

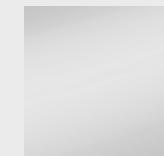

PRO (microprism)

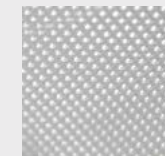

luminaire finishes

- white -13 ○
- black -12 ●

main material

aluminium | PC (opal) | PMMA (microprism)



LUMINAIRES DESIGNED FOR LARGE INTERIORS

Lighting large, high-ceilinged interiors can be a significant challenge. How can the right amount of general illumination be achieved in such spaces? The luminaires from the BIG SIZE collection rise to the occasion, offering high luminous efficacy. Strong technical parameters combined with a timeless design make them a suitable solution for most interiors where both power and size play a key role.



RAFTER points



Luminaires from the RAFTER collection represent high-quality lighting enclosed in a sleek form. The points version is perfect for precise task lighting, the LED variant with an opal diffuser provides soft general illumination, while RAFTER mix addresses multiple needs within a single product. Spot modules deliver directional downlight, LED modules provide sufficient ambient lighting, and PET spotlights are the ideal solution for accent lighting.

RAFTER points LED spot

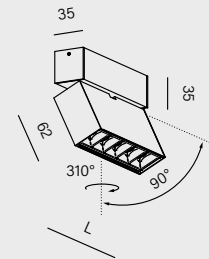

length	cat. n°
93mm	16471-M930-WB-00-12
138mm	16472-M930-WB-00-12
power:	3W - 5W (M)
flux:	366lm - 602lm
optics:	37° (F) 50° (W)
CCT:	2700K (27) 3000K (30) 4000K (40)
control:	ON/OFF (00) Phase-Control (PH)



RAFTER points LED - | section

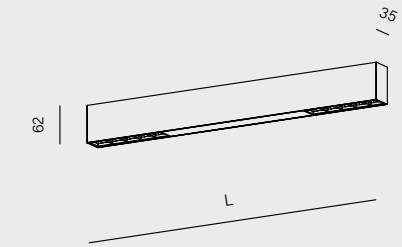
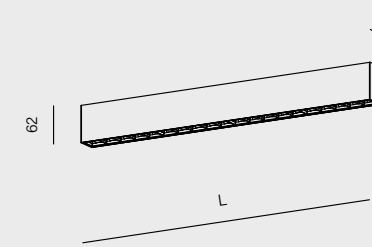

length	cat. n°	length	cat. n°
93mm	47030-M930-WB-00-12	536mm	40520-M930-WB-00-12
138mm	47031-M930-WB-00-12	936mm	40521-M930-WB-00-12
271mm	40525-L930-WB-00-12	1335mm	40522-M930-WB-00-12
537mm	40526-L930-WB-00-12	1734mm	40523-M930-WB-00-12
537mm	40526-M930-WB-00-12	2133mm	40524-M930-WB-00-12
power:	7.5W - 14.5W (L) 3W - 29.5W (M)	power:	7.5W - 22W (L) 14.5W - 44W (M)
flux:	366lm - 3516lm	flux:	917lm - 5274lm
optics:	37° (F_) 50° (W_)	optics:	37° (F_) 50° (W_)
CCT:	2700K (27) 3000K (30) 4000K (40)	CCT:	2700K (27) 3000K (30) 4000K (40)
control:	ON/OFF (00) Phase-Control (PH) ¹ switchDIM (SW) ² DALI (DA) ² AQsmart (DB) ²	control:	ON/OFF (00) Phase-Control (PH) ¹ switchDIM (SW) ² DALI (DA) ² AQsmart (DB) ²



¹ for length 93 and 138mm | ² from length 536mm

Information about dimensions of optics placement within the luminaire are on page 642.

optics detail

black -_B-

white -_W-

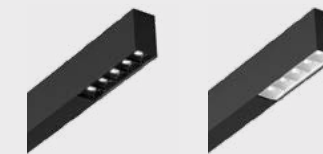

optics finishes

- white -_W ○
- black -_B ●

luminaire finishes

- white -13 ○
- black -12 ●

main material
aluminium | PC



CHOOSE
VERSATILE
SOLUTIONS

RAFTER



recessed p. 104-114
surface
 suspended p. 328-330
 track p. 430-438
 wall p. 494
 systems p. 618

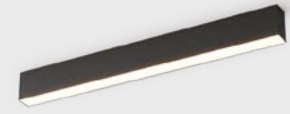

RAFTER LED

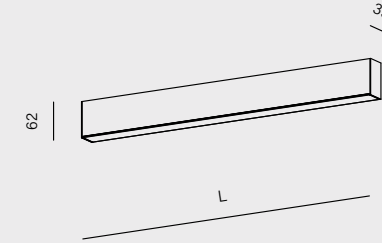

length	cat. n°
570mm	40529-M930-D9-00-12
860mm	40530-M930-D9-00-12
1140mm	40531-M930-D9-00-12
1421mm	40532-M930-D9-00-12
1700mm	40533-M930-D9-00-12
1980mm	40534-M930-D9-00-12
power:	8.5W - 30W (L) 17W - 60W (M) 25W - 87W (H)
flux:	1164lm - 10864lm
optics:	opal diffuser (D9)
CCT:	2700K (27) 3000K (30) 4000K (40)
control:	ON/OFF (00) switchDIM (SW) DALI (DA) Aqsmart (DB)



luminaire finishes

- white -13 ○
- black -12 ●
- brutal -85 ●

main material

aluminium | PMMA



RAFTER mix LED surface

RAFTER mix

recessed p. 104-114
surface
 suspended p. 328-330
 track p. 430-438
 wall p. 494
 systems p. 618

RAFTER

A PERFECT BALANCE OF FORM AND FUNCTION

RAFTER mix LED 57 | 94 | 133 | 136

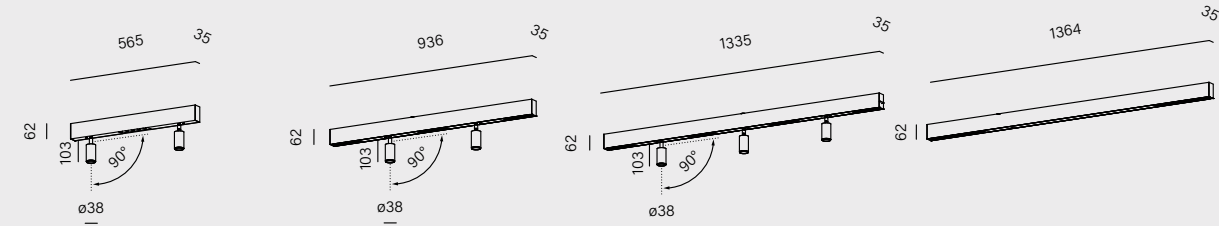

	cat. n°	cat. n°	cat. n°	cat. n°
	46910-M930-WB-00-12	46911-M930-WB-00-12	46912-M930-WB-00-12	46913-M930-WB-00-12
power:	16W (M)	30.5W (M)	42.5W (M)	38W (M)
flux:	1915lm	3574lm	4947lm	4482lm
optics (points modules):	37° (F_) 50° (W_)			
CCT:	2700K (27) 3000K (30) 4000K (40)			
control:	ON/OFF (00)		ON/OFF (00) switchDIM (SW) DALI (DA) AQsmart (DB)	

optics detail

opal diffuser

PET modules

points modules
black -_B-

points modules
white -_W-

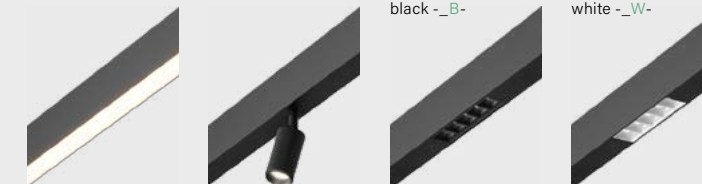

optics finishes

for points modules

white -_W-

black -_B-

luminaire finishes

white -13

black -12

brutal -85

main material

aluminium | PC (points modules) | PMMA (opal)

MIXLINE



MIXLINE is a multifunctional luminaire that performs effectively as both general and task lighting. The LED module provides the right amount of light for work surfaces or floors, while the diffuser supports ambient illumination. MIXLINE is a proven solution suitable for both public and private spaces. Thanks to its minimalist form, it integrates well with most contemporary interior designs.

recessed p. 116
surface
 suspended p. 324
 systems p. 606



MIXLINE LED - | INV

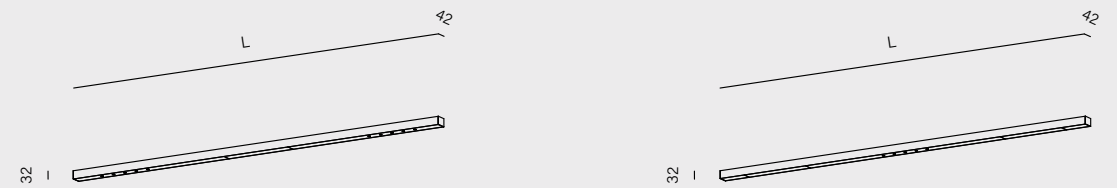

length	cat. n°	length	cat. n°
1600mm	40286-M930-W3-00-12	1670mm	40289-M930-W3-00-12
1880mm	40287-M930-W3-00-12	1920mm	40290-M930-W3-00-12
2160mm	40288-M930-W3-00-12		
power:	16W - 33W (M)		21W - 24.5W (M)
flux:	2064lm - 4392lm		2778lm - 3228lm
optics:	26° (F_) 54° (W_)		
CCT:	2700K (27) 3000K (30) 4000K (40)		
control:	ON/OFF (00) switchDIM (SW) DALI (DA) Aqsmart (DB)		



Information about dimensions of optics placement within the luminaire are on page [642](#).



luminaire finishes

- white -13
- black -12
- brutal -85

main material

aluminium | PMMA



THE MIXLINE COLLECTION
COMBINES MULTIFUNCTIONALITY
WITH A SUBTLE FORM
THIS LUMINAIRE
IS AN EXCELLENT CHOICE
FOR BOTH TASK AND GENERAL
LIGHTING



Discover the
wide-ranging
possibilities
of the MIXLINE
luminaire family



LENS LINE stands out with its slim profile and linear lens arrangement. Depending on the selected version, the luminaire performs well as general lighting, simultaneously illuminating the space and surrounding walls, or, in a version with a narrower beam angle, as task lighting suitable for areas such as worktops. LENS LINE is yet another modern lighting solution that adds character to the interior.

LENS LINE



recessed p. 118
surface
 suspended p. 322



LENS LINE LED - | section | 180x89 LC | 180x89 RC

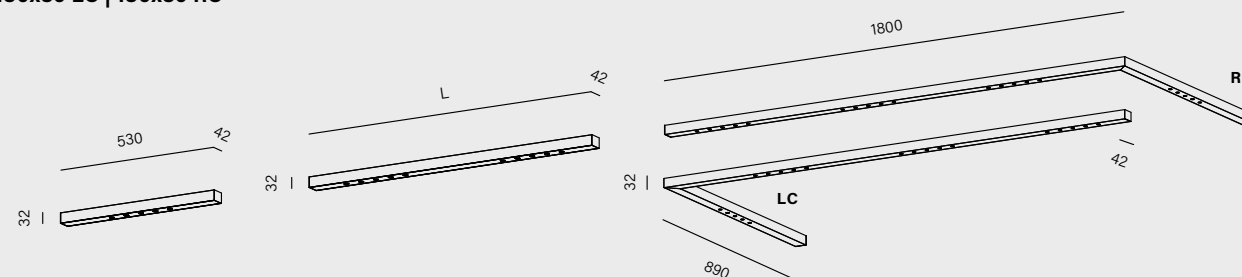

	cat. n°	length	cat. n°	cat. n°	cat. n°
	40258-M930-W3-00-12	960mm	40260-M930-W3-00-12	LC 47024-M930-W3-00-12	RC 40292-M930-W3-00-12
		1490mm	40262-M930-W3-00-12		
		2020mm	40264-M930-W3-00-12		
power:	7.5W (M)	7W - 14.5W (L) 14.5W - 29.5W (M)		14.5W (L) 29.5W (M)	
flux:	886lm	923lm - 3545lm		1846lm - 3545lm	
optics:				26° (F_) 54° (W_)	
CCT:				2700K (27) 3000K (30) 4000K (40)	
control:	ON/OFF (00)			ON/OFF (00) switchDIM (SW) DALI (DA) Aqsmart (DB)	

Information about dimensions of optics placement within the luminaire are on page [642](#).



optics finishes
 white -_W
 black -_B

luminaire finishes
 white -13
 black -12
 brutal -85

main material
 aluminium

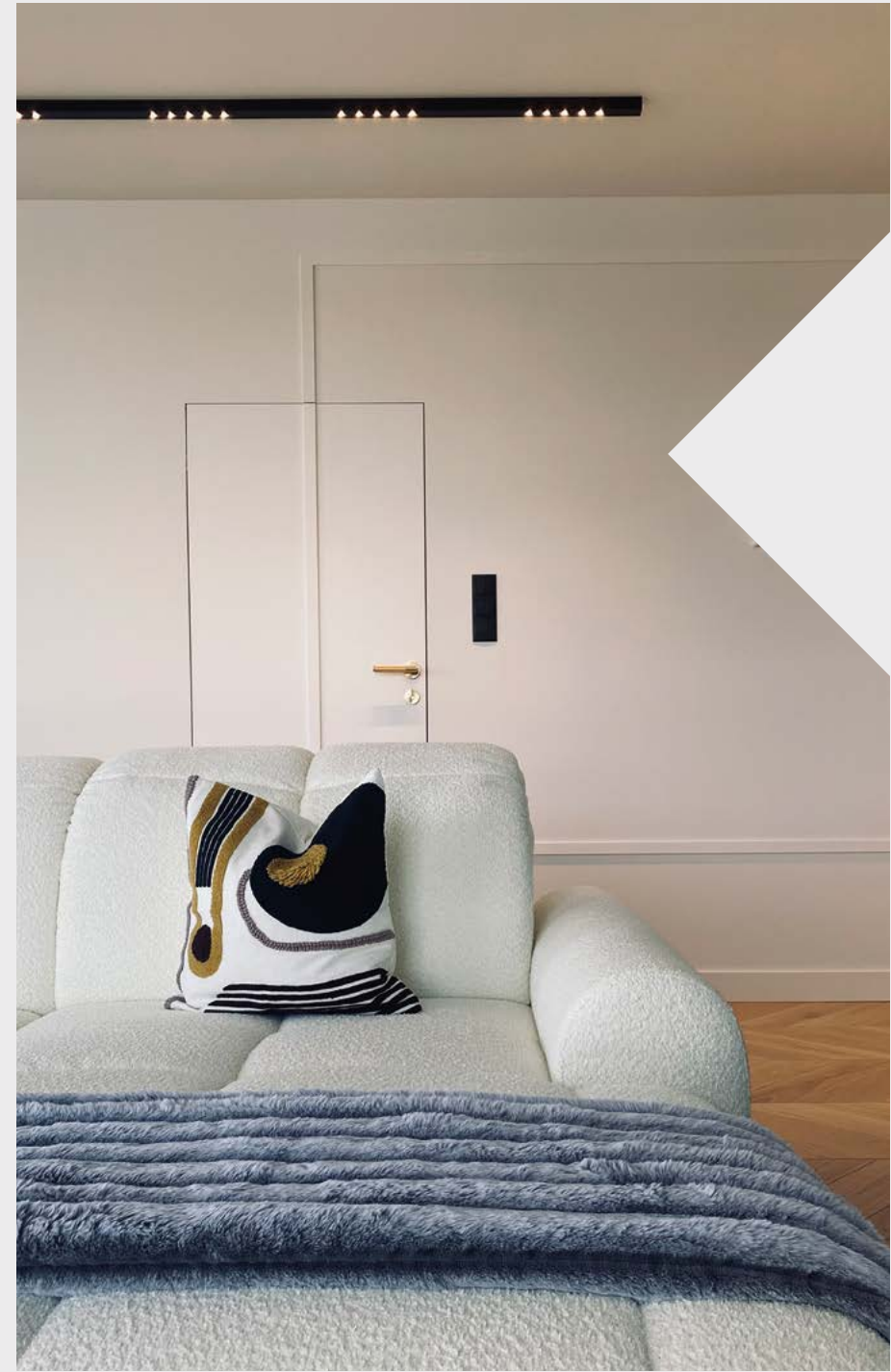

SUBTLE

recessed p. 122
surface
 suspended p. 338
 wall p. 496
 systems p. 614



TRU

The TRU collection was designed with office spaces in mind. It combines elegance with energy efficiency, providing effective lighting across the entire space. TRU is a proven solution for general lighting. In its hermetic version, with an increased ingress protection rating (IP44), it performs well in areas exposed to moisture.



SET TRU LED - | hermetic

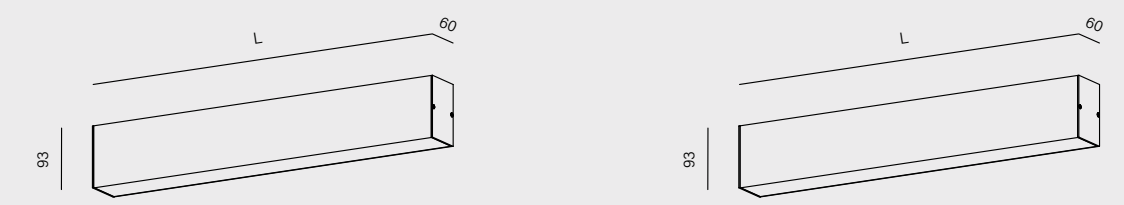

length	cat. n°	length	cat. n°
290mm	45942-M930-D9-00-12	570mm	40082-M930-D9-00-12
570mm	45944-M930-D9-00-12	860mm	40084-M930-D9-00-12
860mm	45948-M930-D9-00-12	1140mm	40086-M930-D9-00-12
1140mm	45950-M930-D9-00-12	1420mm	40088-M930-D9-00-12
1420mm	45952-M930-D9-00-12	1700mm	40027-M930-D9-00-12
1700mm	45954-M930-D9-00-12	1980mm	40029-M930-D9-00-12
1980mm	45956-M930-D9-00-12		
power: 4.5W - 30W (L) 8.5W - 60W (M)		8.5W - 30W (L) 17W - 60W (M)	
flux: 582lm - 8148lm		1164lm - 8148lm	
optics: opal (D9) microprism (D5)		opal (D9)	
CCT: 2700-6500K (62) ¹ 2700K (27) 3000K (30) 4000K (40)			
control: ON/OFF (00) switchDIM (SW) ² DALI (DA) ² Aqsmart (DB) ²			

¹from length 1140mm | ²from length 570mm
 the opal version (D9) has a Tunable-White option available from length 1140mm

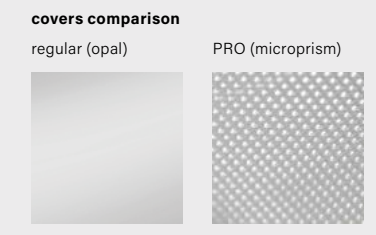

- luminaire finishes**
- white -13 ○
 - black -12 ●
 - brutal -85 ●
- main material**
 aluminium | PMMA



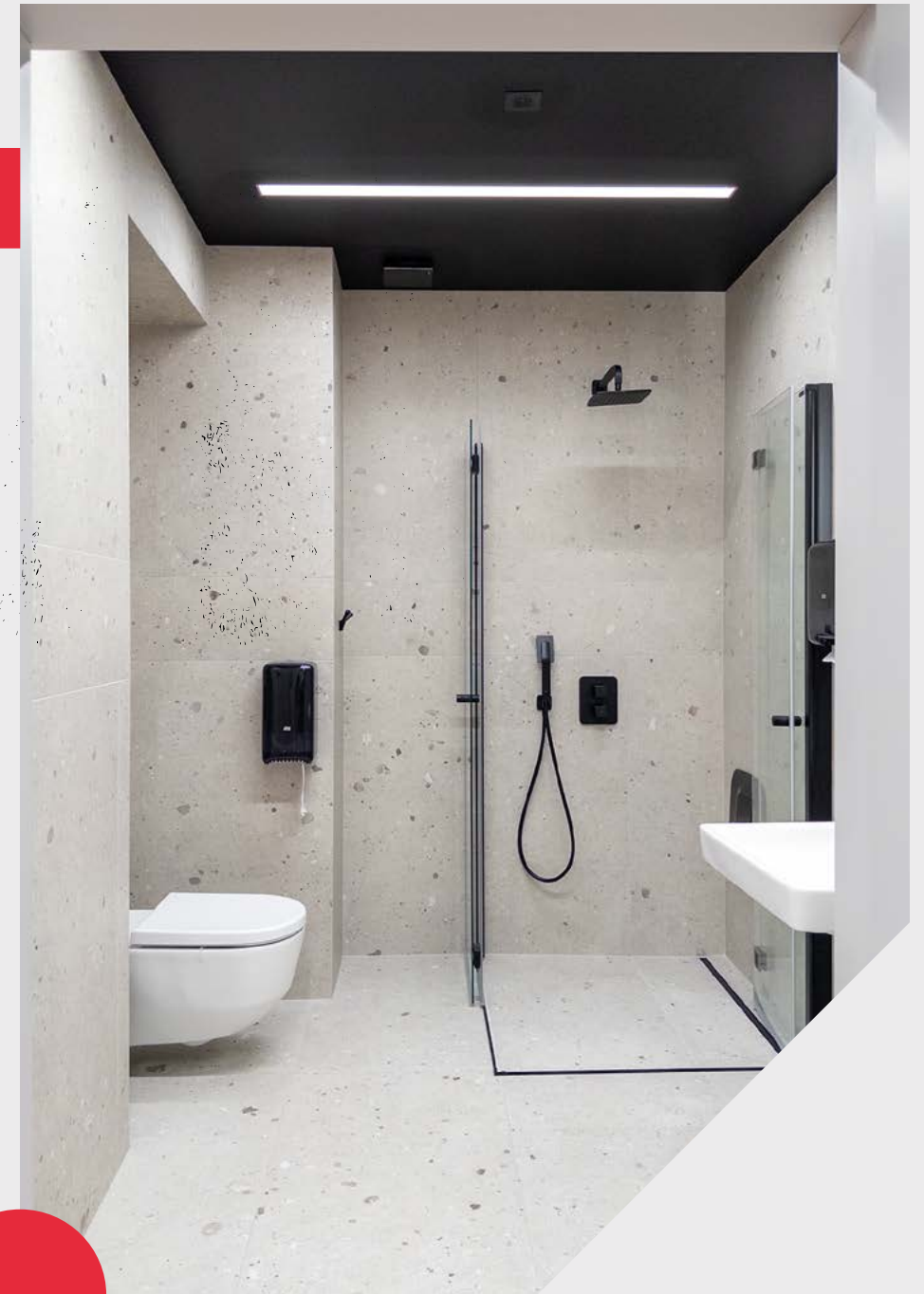
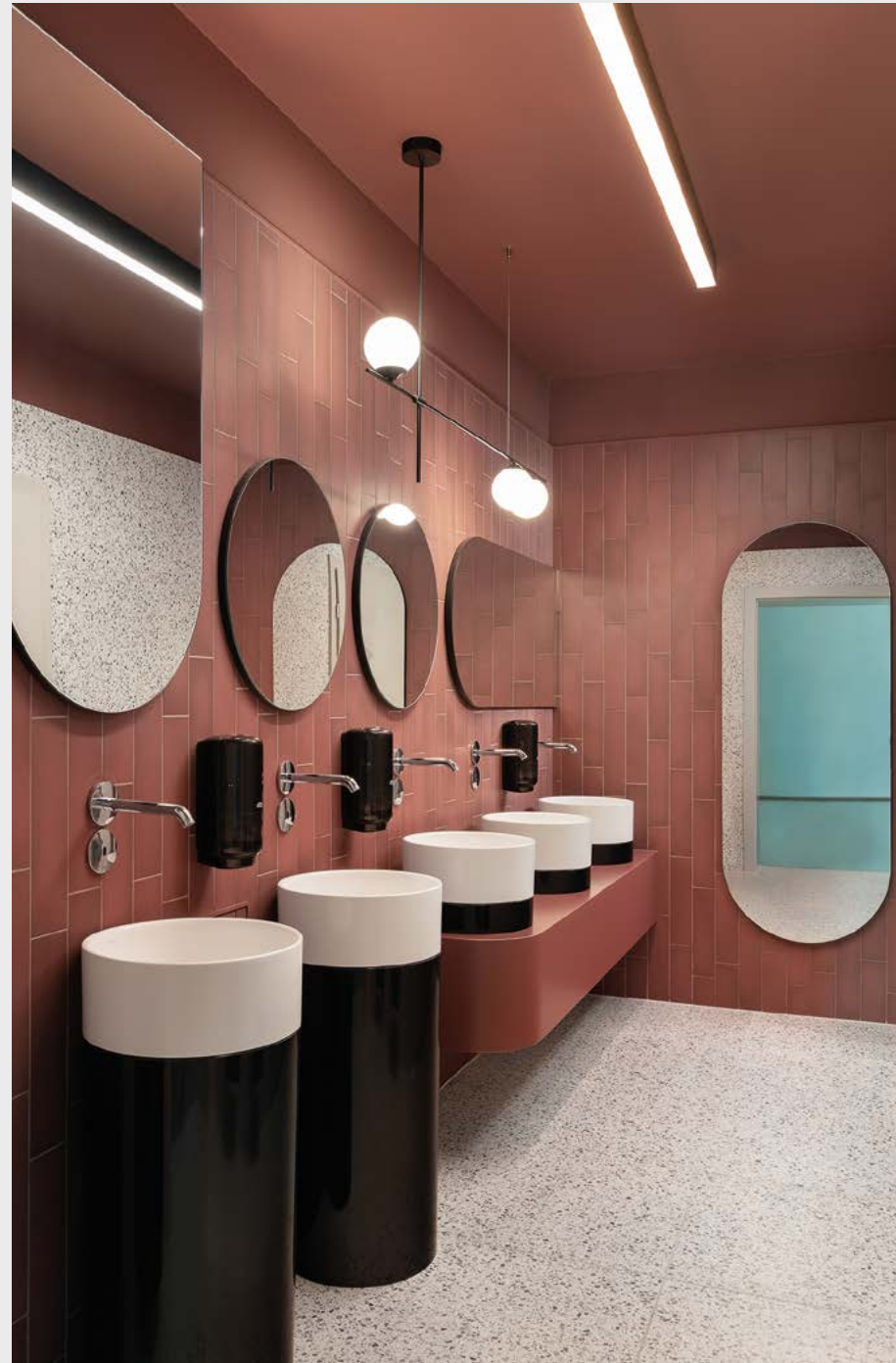

INTERIOR
SUSPENDED

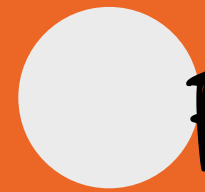
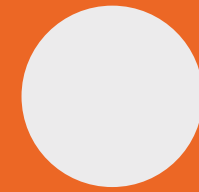

FUNCTIONAL

AND MODERN

INTERIOR SUSPENDED

Suspended luminaires offer a broad range of possibilities, from decorative models to precise task-oriented solutions. They work well above tables, desks, as well as in tall interiors, combining functionality with refined form.



BUCLO down LED suspended

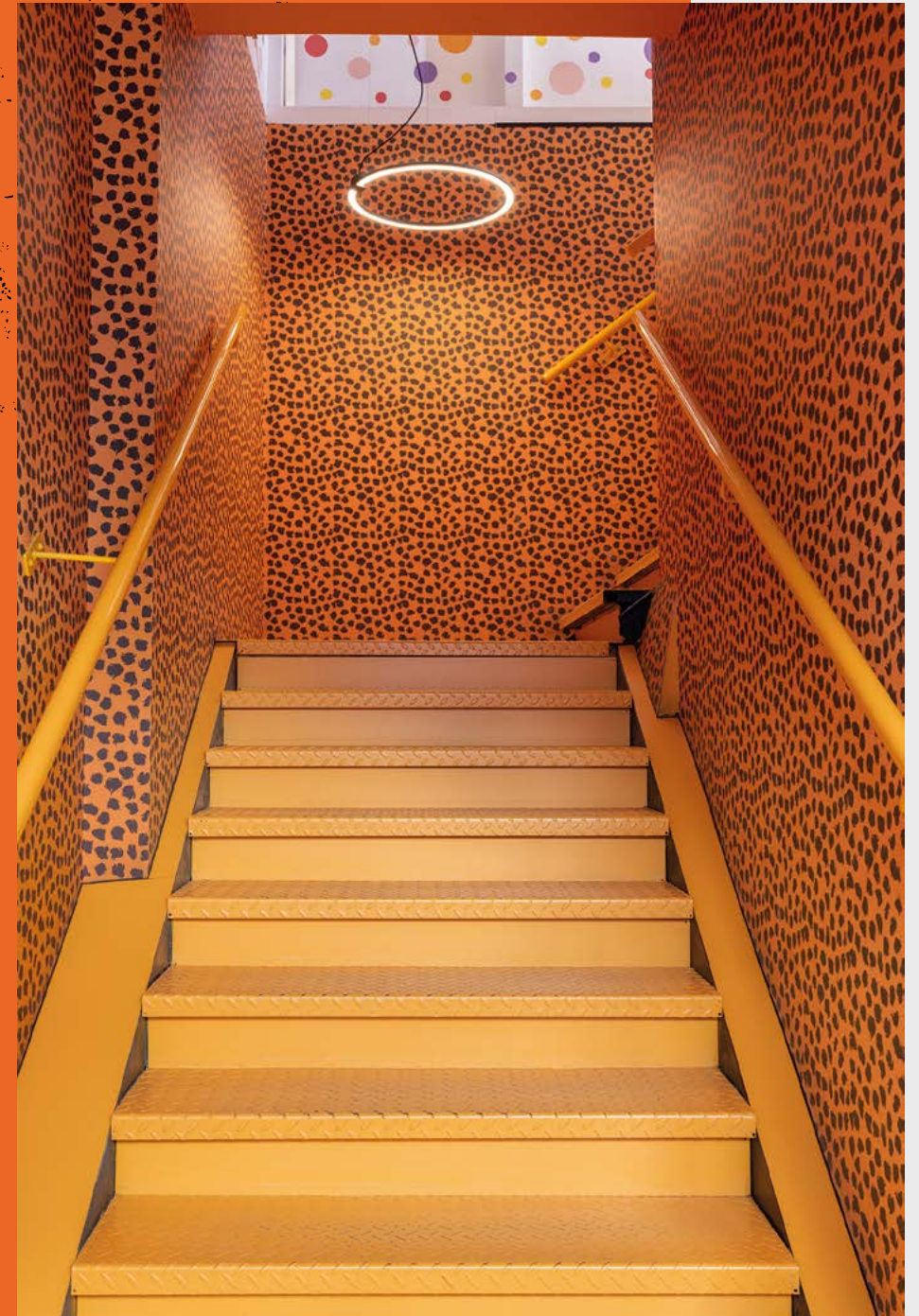



RIBBY line up&down LED suspended

STYLISH FORM

CONA LED suspended

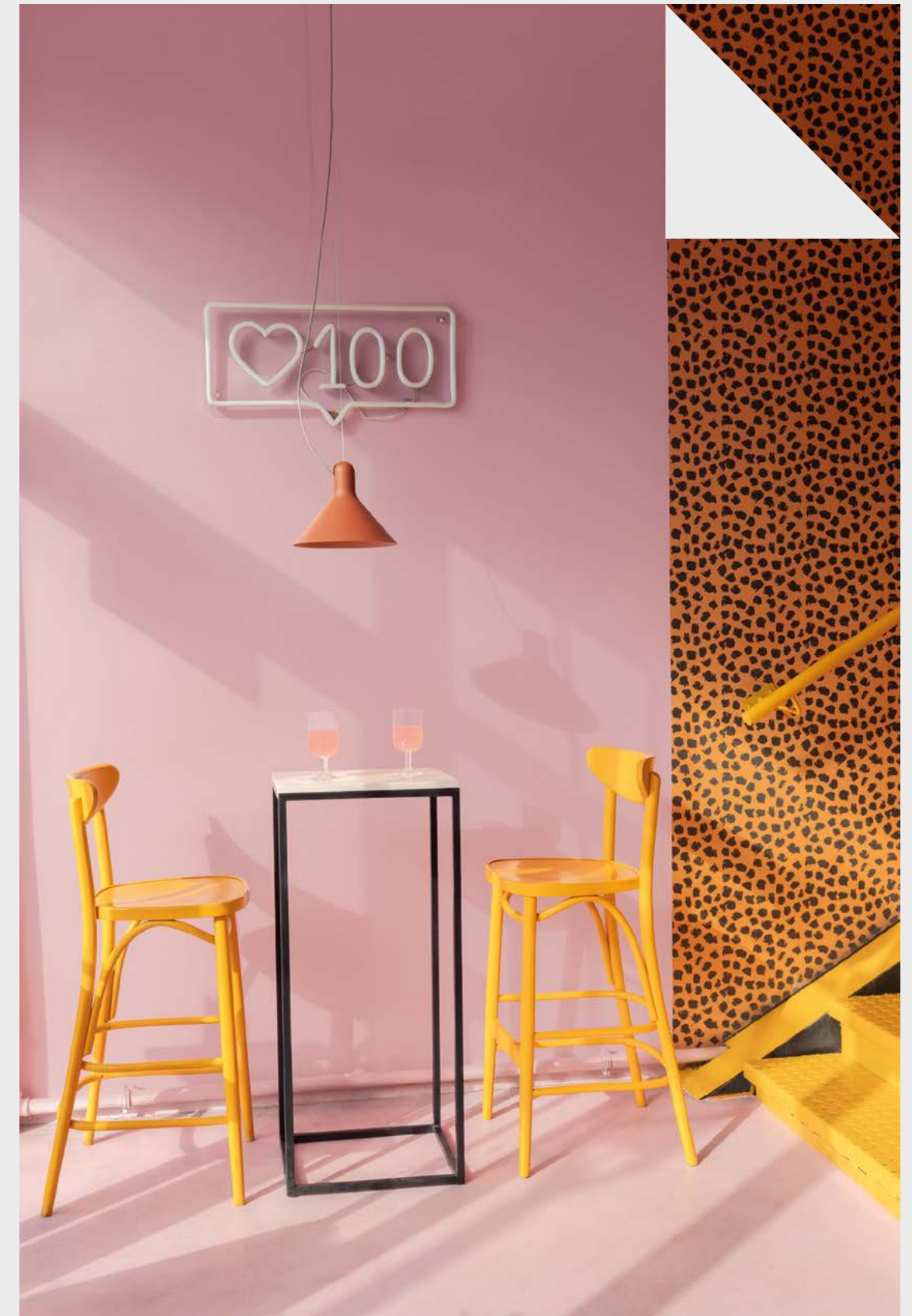

BEADS

BEADS is a family of luminaires designed in collaboration with Maciej Ferenc, featuring a distinctive motif of 'beads' in the form of glass shades. The luminaires are available in both vertical and horizontal versions and incorporate three basic shade shapes and their combinations. A specially designed LED module is placed inside the glass elements and fitted with a frosted diffuser, emphasising the decorative character of the design.



NEW PRODUCT



BEADS
horiz line 120 | horiz line 200 | vert line 120

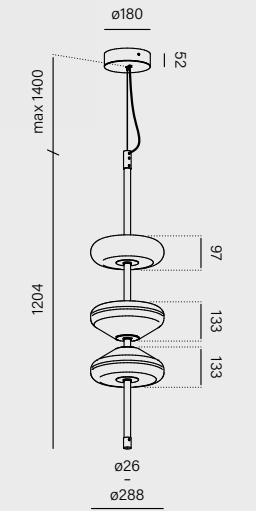
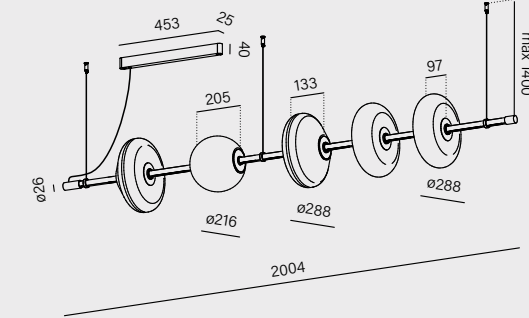
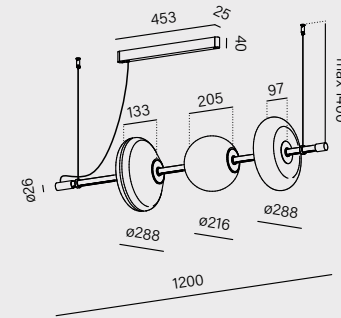

	cat. n°	cat. n°	cat. n°
	57990-M930-PW-00-12	57991-M930-P2-00-12	57992-M930-PJ-00-12
power:	30W (M)	46.5W (M)	26W (M)
flux:	4418lm	6817lm	3828lm
CCT:	2700K (27) 3000K (30) 4000K (40)		
control:	ON/OFF (00) DALI (DA)		
	 cone -PW ball -PW disc -PW	 cone -PJ ball -PI cone -PJ disc -PF disc -PJ	 disc -PJ cone -PJ cone -PJ

Each luminaire is supplied with a dedicated glass shade.



- lampshade finishes**
- plain white -PW ○
 - plain graphite -PJ ●
 - plain fuchsia -PF ●
 - plain indygo -PI ●
 - mix -P2 ●
- luminaire finishes**
- black -12 ●
- main material**
- aluminium | glass | PMMA

BEADS horiz line 200 LED suspended

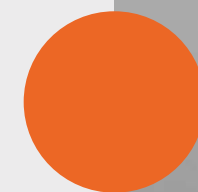

BEADS vert line 120 LED suspended



BEADS cumulus LED suspended



BEADS

BEADS stands out with its refined and highly decorative design in which glass, its shapes and colours play a key role. As a result, it remains visually striking even when switched off. Durability is achieved by combining the established technical standards and the Polish glassmaking tradition. A wide range of variants and configurations allows the fixture to become a key element in shaping the interior's aesthetics.

NEW PRODUCT

BEADS
ball | cone | disc | ovo | cumulus

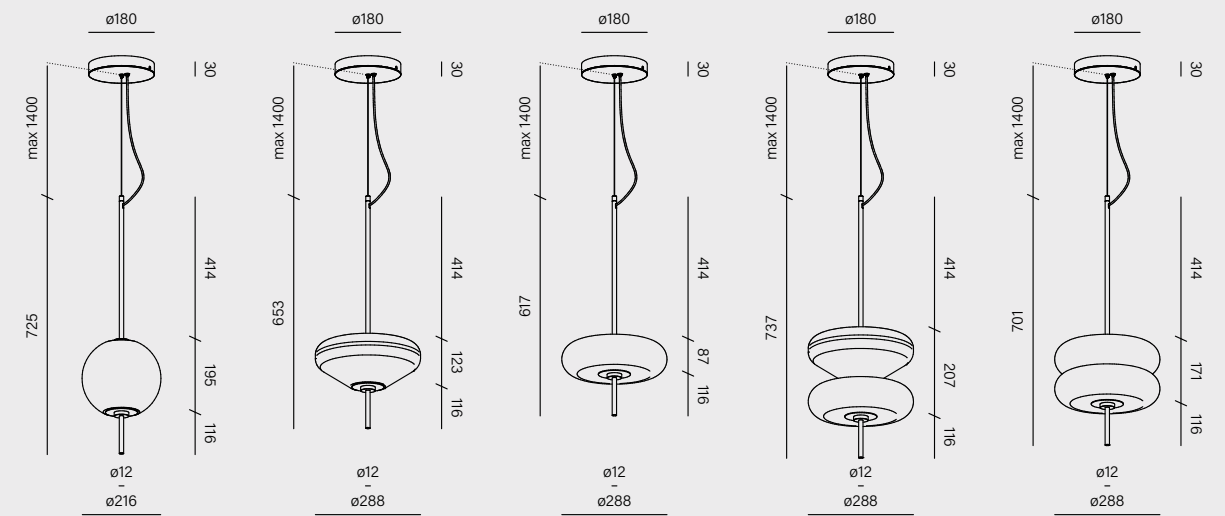

	cat. n°	cat. n°	cat. n°	cat. n°	cat. n°
	59992-M930-PW-00-12	59993-M930-PW-00-12	59994-M930-PW-00-12	59995-M930-PW-00-12	59996-M930-PW-00-12
power:	13.5W (M)	10W (M)	7W (M)	13.5W (M)	14W (M)
flux:	2019lm	1429lm	970lm	2399lm	1941lm
CCT:	2700K (27) 3000K (30) 4000K (40)				
control:	ON/OFF (00) switchDIM (SW) DALI (DA)				

- lampshade finishes**
- plain white -PW ○
 - plain graphite -PJ ●
 - plain fuchsia -PF ●
 - plain indygo -PI ●
- for ovo, the mix finish consists exclusively of PW and PJ
mix -P2 ○
- luminaire finishes**
- white -13 ○
 - black -12 ●
 - burgundy -86 ●
 - terracotta -83 ●
 - sandy -87 ●
 - taupe -82 ●
 - grey -84 ●
 - gold -19 ●

main material
aluminium | glass | PMMA



BEADS disc LED suspended



BEADS ovo LED suspended



Decorative luminaires inspired
by the motif of diverse beads.



RIBBY up&down LED
round | circle

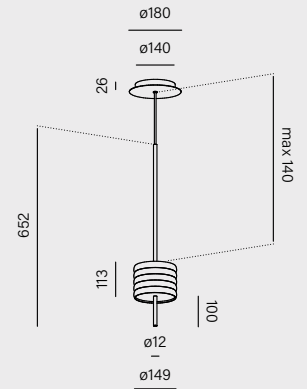

new

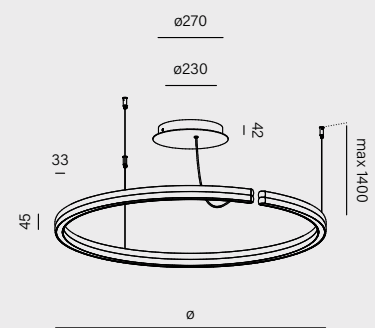

	cat. n°	diameter	cat. n°
	59966-M930-D9-00-12	ø706mm	59963-M930-D9-00-12
		ø974mm	59964-M930-D9-00-12
		ø1280mm	59965-M930-D9-00-12
power:	8W (M)		16W - 29W (L) 26W - 47.5W (M) 52W - 95.5W (H)
flux:	1156lm (M)		1756lm - 11674lm
CCT:	2700K (27) 3000K (30) 4000K (40)		2700K (27) 3000K (30)
control:	ON/OFF (00) switchDIM (SW) DALI (DA) Aqsmart (DB)		ON/OFF (00) 2 circuits (02) switchDIM (SW) DALI (DA) Aqsmart (DB)



RIBBY round & circle

Organic lines, bold shapes, and a touch of vintage flair. The RIBBY collection surprises with a design that goes hand in hand with a contemporary approach to lighting and its functions. The family of the luminaires works well as even illumination above a table, in entrance areas or in lobbies.

- luminaire finishes**
- white -13 ○
 - black -12 ●
 - burgundy -86 ●
 - terracotta -83 ●
 - sandy -87 ●
 - taupe -82 ●
 - grey -84 ●
 - gold -19 ●

main material
aluminium | PC (round) | silicon (circle)





LIGHTING
WITH PERSONALITY





RIBBY line

The RIBBY line is a modern linear luminaire with a minimalist design inspired by nature. It works well in both commercial spaces and private interiors, providing even illumination and a refined finish suited to contemporary arrangements.

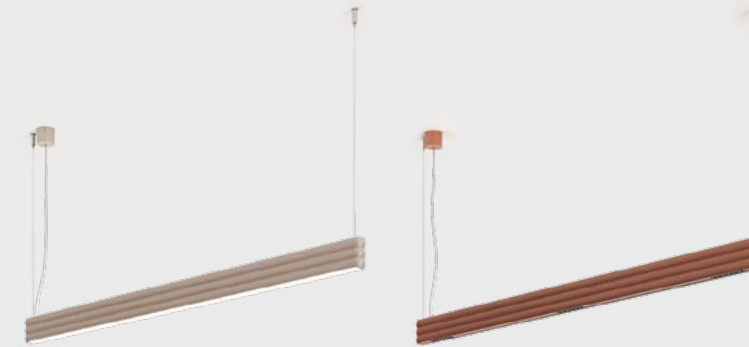

RIBBY up&down LED line | line points

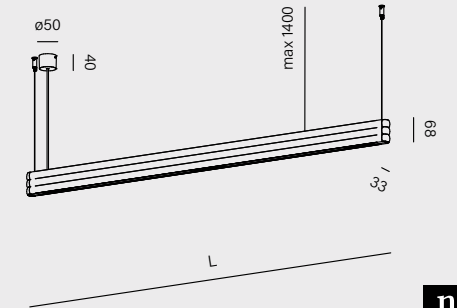
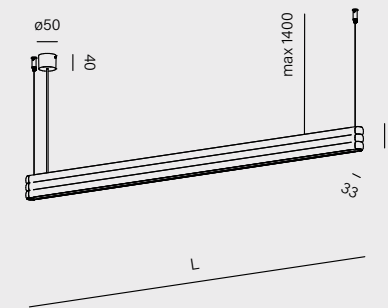

new

length	cat. n°	length	cat. n°
895mm	59960-M930-D9-00-82	750mm	59982-M930-WB-00-83
1135mm	59961-M930-D9-00-82	1250mm	59983-M930-WB-00-83
1495mm	59962-M930-D9-00-82		
power:	5.5W - 10W (L) 9.5W - 16.5W (M) 19W - 33.5W (H)		12.5W - 20W (M)
flux:	634lm - 4068lm		1575lm - 2485lm
optics:	-		45° (W_)
CCT:	2700K (27) 3000K (30)		
control:	ON/OFF (00) 2 circuits (02)* switchDIM (SW) DALI (DA) Aqsmart (DB)		ON/OFF (00) 2 circuits (02) switchDIM (SW) DALI (DA)

* only for H power version

optics finishes

only for line points

- white -_W ○²
- black -_B ●

luminaire finishes

- white -13 ○
- black -12 ●
- burgundy -86 ●
- terracotta -83 ●
- sandy -87 ●
- taupe -82 ●
- grey -84 ●
- gold -19 ●

² the white optics available only with the white luminaire finish

main material

aluminium | silicon





The linear version of RIBBY brings a decorative character to interiors while providing evenly distributed light emitted both upwards and downwards. With three power levels and bi-directional light emission, the desired effect can be precisely achieved, from a warm, ambient glow to functional task lighting.

STYLISH LIGHTING INSPIRED BY NATURE

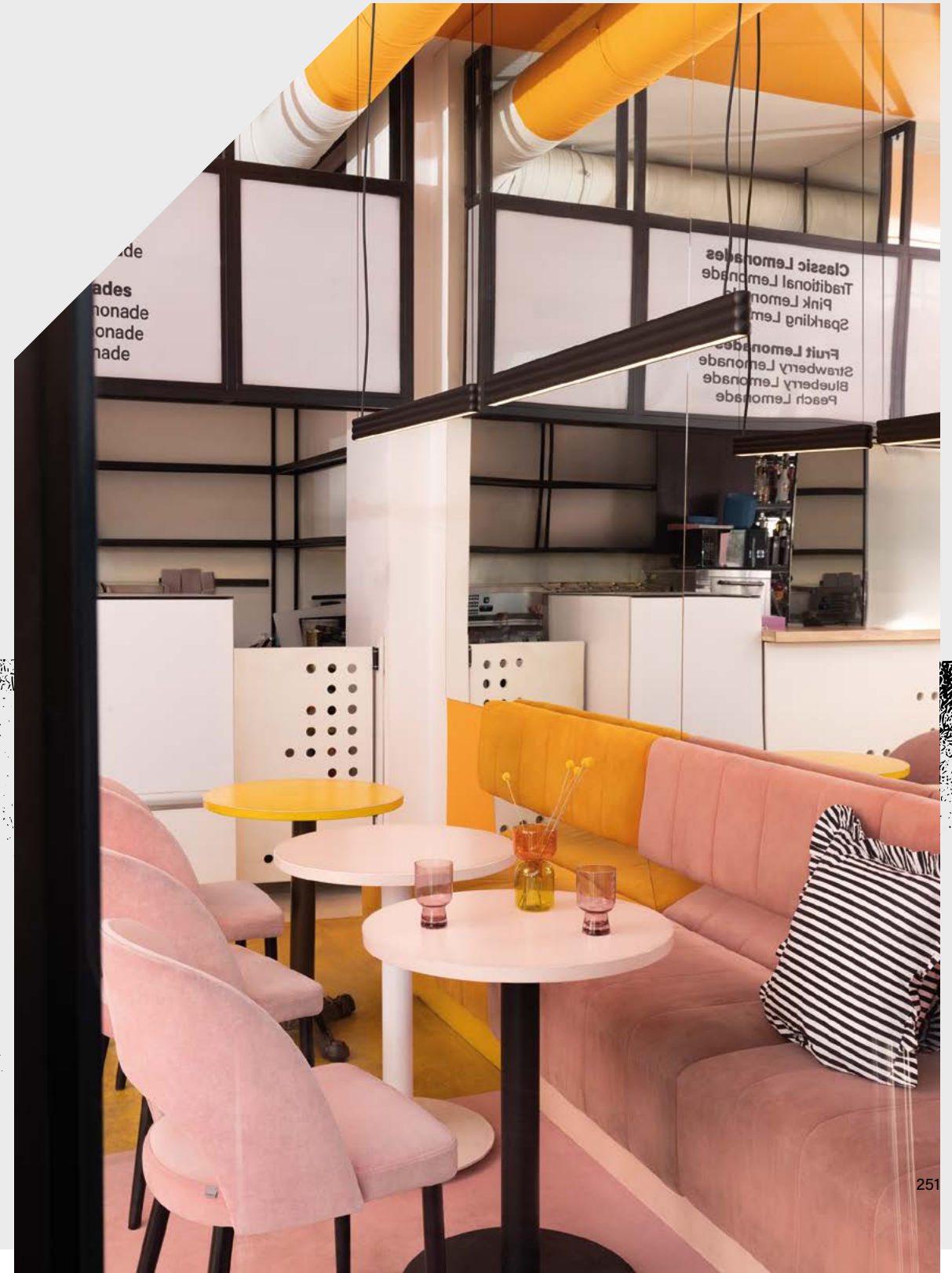



BUCLO

The BUCLO collection is a tribute to all lovers of curves. Its minimalist, lightweight form retains a decorative character, making it well suited to modern interiors. With three lighting modes available, BUCLO is a versatile solution tailored to a wide range of needs.

suspended



BUCLO LED down | in | up

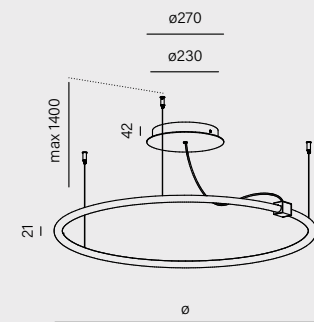
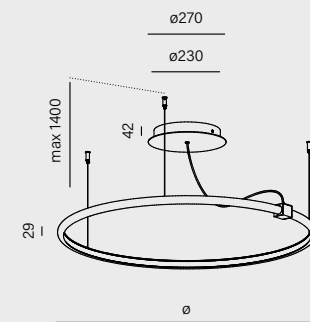
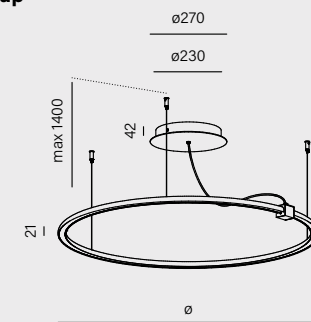

diameter	cat. n°	diameter	cat. n°	diameter	cat. n°
ø611mm	59948-M930-D9-00-12	ø594mm	59951-M930-D9-00-12	ø611mm	59957-M930-D9-00-12
ø920mm	59949-M930-D9-00-12	ø900mm	59952-M930-D9-00-12	ø920mm	59958-M930-D9-00-12
ø1224mm	59950-M930-D9-00-12	ø1206mm	59953-M930-D9-00-12	ø1224mm	59959-M930-D9-00-12
power:		6.5W - 13.5W (L) 11W - 22.5W (M) 22W - 45W (H)			
flux:		731lm - 5483lm			
CCT:		2700K (27) 3000K (30)			
control:		ON/OFF (00) switchDIM (SW) DALI (DA)			



luminaire finishes

- white -13
- black -12
- burgundy -86
- terracotta -83
- sandy -87
- taupe -82
- grey -84
- gold -19

main material

aluminium | silicon



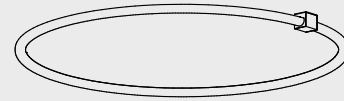

BUCLo UP
provides ideal, glare-free
general lighting in interiors
with light-coloured ceilings.

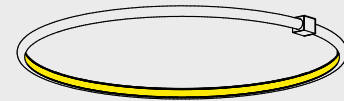

BUCLo IN
adds a touch of decorative flair
to any space.



BUCLo DOWN
works well as general lighting
in large spaces.

BUCLo is an elegant luminaire with a modern character, combining functionality with aesthetics and offering pleasant, diffused light.



suspended

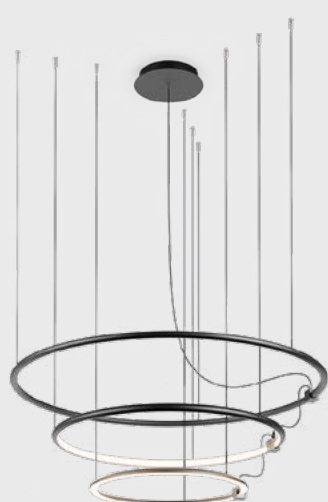

BUCLO LED
chain | ripples

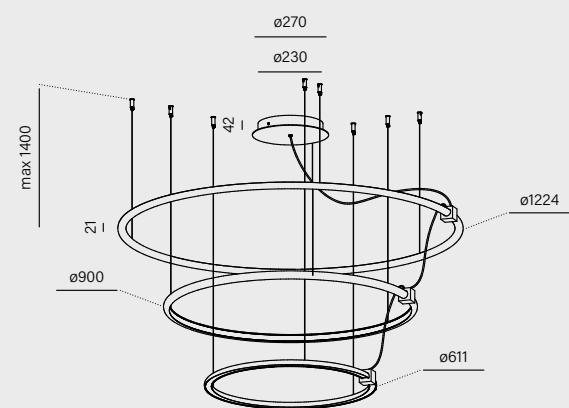
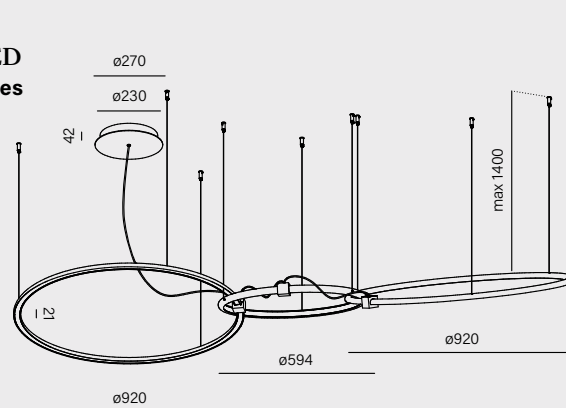

BUCLO LED
hoop | giro

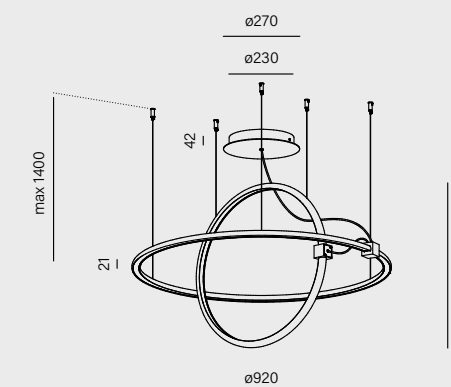
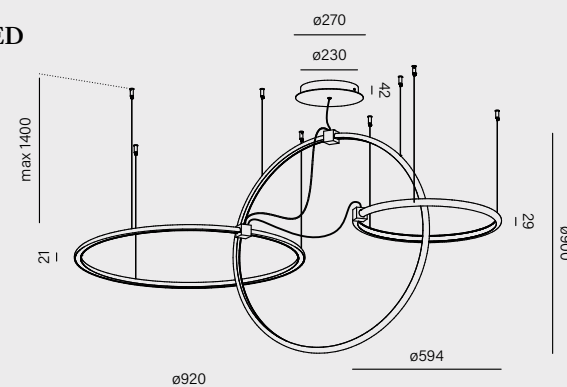

	cat. n°	cat. n°
	59985-L930-D9-00-12	59986-L930-D9-00-12
power:	27W (L)	31W (L)
flux:	2976lm	3366lm
CCT:	2700K (27) 3000K (30)	
control:	ON/OFF (00) switchDIM (SW) DALI (DA)	

	cat. n°	cat. n°
	59987-L930-D9-00-12	59061-L930-D9-00-12
power:	27W (L)	16.5W (L)
flux:	2976lm	1854lm
CCT:	2700K (27) 3000K (30)	
control:	ON/OFF (00) switchDIM (SW) DALI (DA)	

BUCLO **NEW PRODUCT**



luminaire finishes

- white -13
- black -12
- burgundy -86
- terracotta -83
- sandy -87
- taupe -82
- grey -84
- gold -19

main material

aluminium | silicon

BUCLO LED

BUCLO chain LED suspended



BUCLO LED Chain and Hoop are pendant luminaires designed as a striking composition based on the well-known BUCLO in and down versions. Different directions of light emission are combined within a single fixture, providing both decorative form and general lighting. This solution is intended for larger, representative interiors.

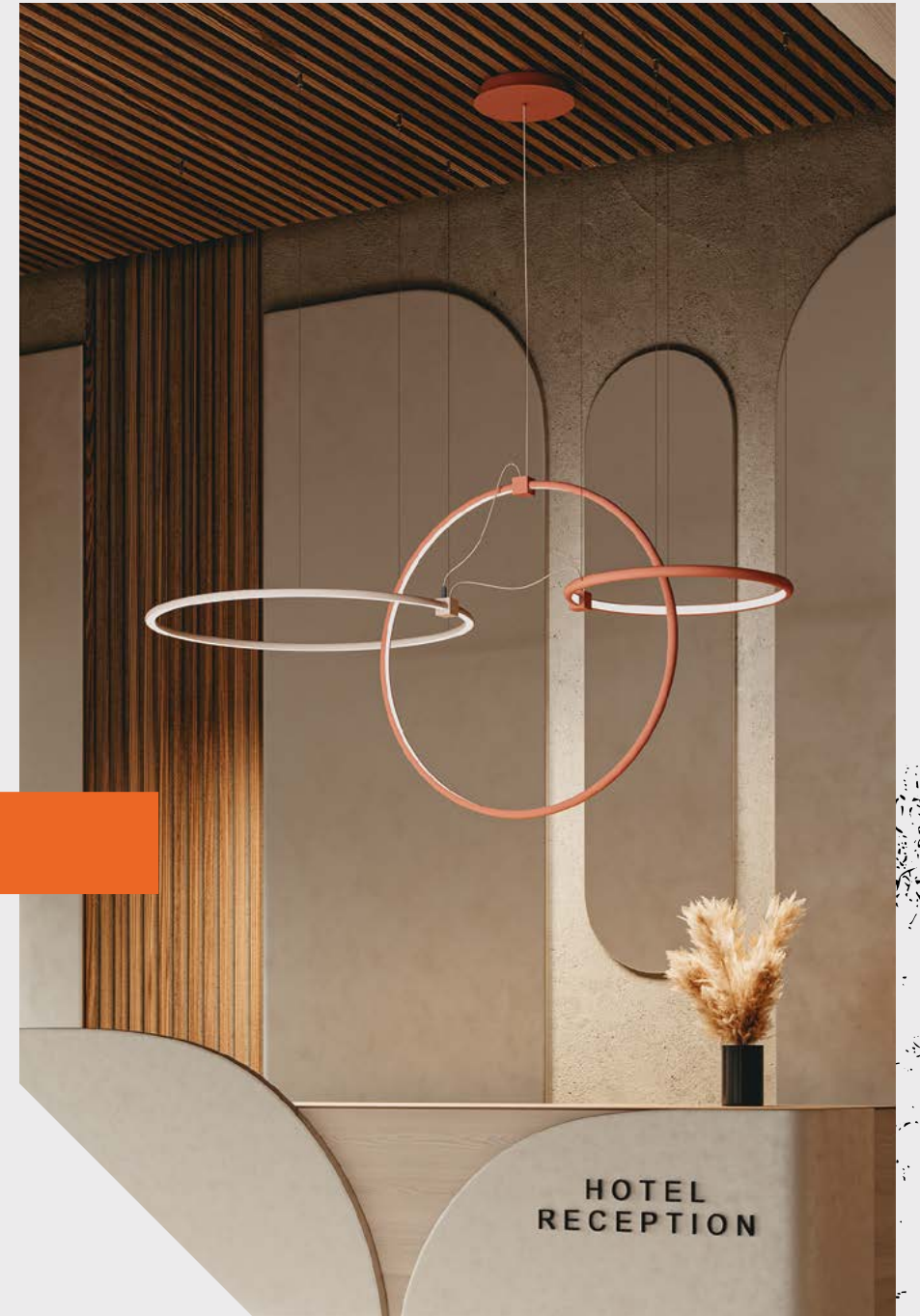

BUCLO giro LED suspended



BUCLO LED Giro and Ripples are pendant luminaires that expand on the concept of layered lighting introduced in the BUCLO collection. Ripples combines the up, in and down versions, delivering light reflected from the ceiling, a decorative accent and illumination of the space below. Giro pairs the in and down versions, creating a more compact solution for residential interiors.



BUCLO ripples LED suspended

A spectacular composition featuring layered lighting in a single luminaire



CONA LED suspended

CONA

CONA is a decorative suspended luminaire that captivates with its form. In the version with replaceable light sources, it works well as atmospheric table lighting or relaxing general illumination. The LED variant, in turn, delivers the appropriate amount of light for work surfaces such as tables, counters or reception desks.

Awarded products: CONA E27



CONA
LED | E27

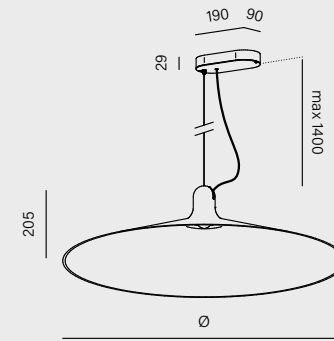

diameter	cat. n°
ø260mm	59942-M930-W1-00-12
ø520mm	59943-M930-W1-00-12
ø750mm	59944-M930-W1-00-12
power:	6W (L) 9W (M)
flux:	834lm - 1134lm
optics:	52° (W)
CCT:	2700K (27) 3000K (30) 4000K (40)
control:	ON/OFF (00) Phase-Control (PH) DALI (DA)

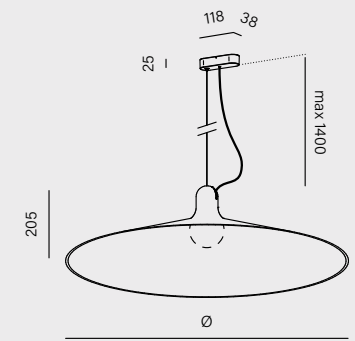

diameter	cat. n°
ø260mm	59917-E000-00-PH-12
ø520mm	59918-E000-00-PH-12
ø750mm	59945-E000-00-PH-12
power:	max: 50W
control:	Phase-Control (PH)



light source not included

luminaire finishes

- white -13 ○
- black -12 ●
- brutal -85 ●
- burgundy -86 ●
- terracotta -83 ●
- sandy -87 ●
- taupe -82 ●
- grey -84 ●
- gold -19 ●

*only for 260mm and 520mm

main material

aluminium | optical glass (LED version)





Stylish
lighting
with
a decorative
character



SNOP QRLED suspended | SNOP E27 suspended



SNOP

SNOP is a decorative luminaire that blends craftsmanship with modern technology. Hand-braided cords form openwork structures that, depending on the selected colour variant, can be subtly integrated into the space or serve as a bold accent within the overall arrangement.



surface p.140
suspended

SNOP

FUNCTIONAL AND MODERN

SNOP QRLED | E27

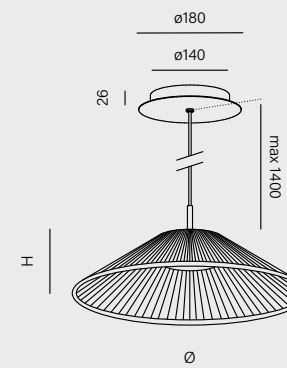

dimensions	cat. n°
ø406mm H 105mm	59925-M930-W3-00-B2
ø606mm H 145mm	59926-M930-W3-00-B2
power:	6W (L) 9W (M)
flux:	834lm - 1134lm
optics:	52° (W)
CCT:	2700K (27) 3000K (30) 4000K (40)
control:	ON/OFF (00) Phase-Control (PH) DALI (DA)

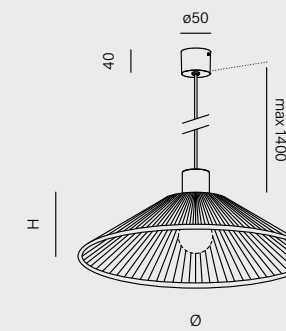

dimensions	cat. n°
ø406mm H 105mm	59923-E000-00-PH-B2
ø606mm H 145mm	59924-E000-00-PH-B2
power:	max: 15W
control:	Phase-Control (PH)

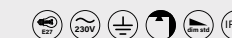

light source not included

luminaire finishes*

- black + terracotta shade -R2
- mix + terracotta shade -R6
- black + black shade -B2
- mix + black shade -B6
- black + khaki shade -K2
- mix + khaki shade -K6

*only for SNOP QRLED

main material

steel | aluminium | optical glass (LED version) | PPE+PA | synthetic lace



SNOP QRLED suspended



The SNOP collection is more than just luminaires; it represents a fusion of modern technology and handcrafted artistry. Depending on the selected variant, SNOP with replaceable E27 light sources creates an atmospheric ambiance, while the LED version delivers precise illumination where it is most needed.

SNOP E27 suspended | PET micro LED upright



A PERFECT DUO
OF MODERN TECHNOLOGY
AND HANDCRAFTED DESIGN

FLARED cast

FLARED cast combines industrial aesthetics with an innovative approach to materials. Made from synthetic gypsum used in dentistry, it is distinguished by a raw, porous yet lightweight form. The LED version works well as functional task lighting, while the variant with replaceable light sources creates an atmospheric effect in living rooms or restaurants.



FLARED cast G
LED | E27

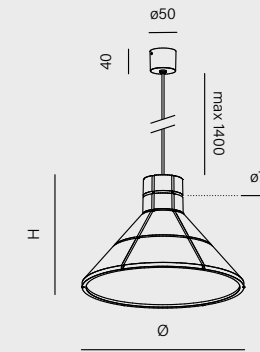

dimensions	cat. n°
ø195mm H 200mm	59921-M930-D9-00-12
ø320mm H 220mm	59922-M930-D9-00-12
power:	8.5W (M)
flux:	1149lm
CCT:	2700K (27) 3000K (30) 4000K (40)
control:	ON/OFF (00) Phase-Control (PH)

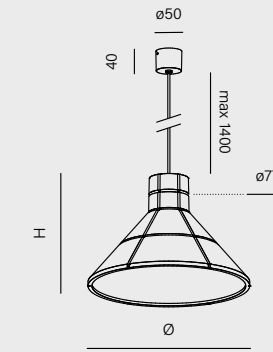

dimensions	cat. n°
ø195mm H 200mm	59919-E000-00-PH-12
ø320mm H 220mm	59920-E000-00-PH-12
power:	max: 50W
control:	Phase-Control (PH)

light source not included

luminaire finishes

- white -13 ○
- black -12 ●
- burgundy -86 ●
- terracotta -83 ●
- sandy -87 ●
- taupe -82 ●

main material

synthetic gypsum | aluminium



IKI



In Japanese culture, the concept of IKI is defined as beauty and elegance, which inspired the creation of a luminaire bearing the same name and similar character. IKI was developed in collaboration with Professor Andrzej Klisz from the Academy of Fine Arts in Katowice. Depending on the variant, it serves either as effective task lighting or diffused decorative illumination.

IKI E27

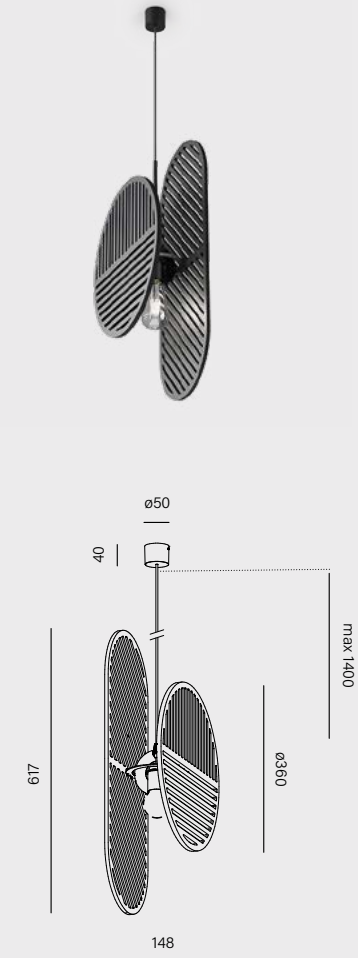

cat. n°	59871-E000-00-PH-O2
power:	15W
control:	Phase-Control (PH)

light source not included

black&graphite panel -G2 black&ash panel -A2 black&orange panel -O2

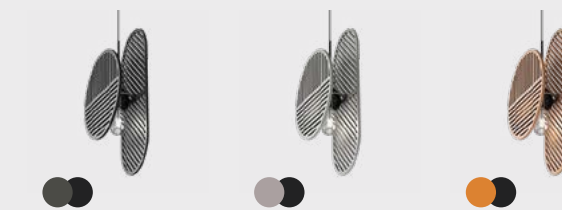

luminaire finishes
 black&graphite panel -G2 ●●
 black&ash panel -A2 ●●
 black&orange panel -O2 ●●

main material
 MDF | steel | aluminium

PIPER

PIPER is distinguished by its slim form and subtle presence in the interior. It provides even illumination of tables, countertops, and entire spaces, with the option to select from three different colour temperatures. The availability of two lengths allows the luminaire to be adapted to the scale of the project.



PIPER LED 230V
- | vert

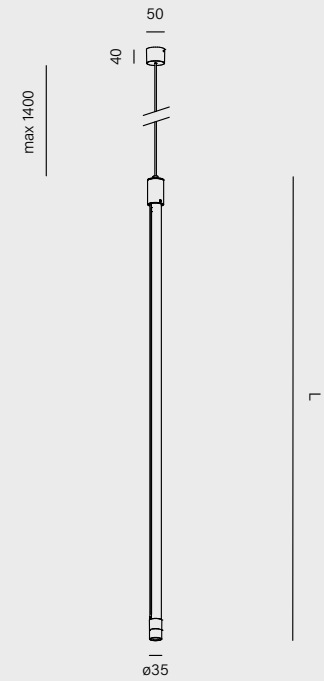
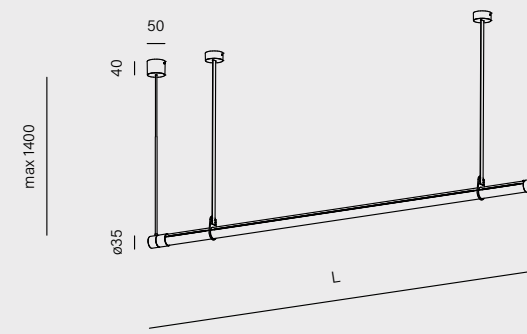

length	cat. n°	length	cat. n°
1318mm	59936-M942-D9-PH-12	1330mm	59939-M942-D9-PH-12
1543mm	59937-M942-D9-PH-12	1555mm	59940-M942-D9-PH-12

power: 23.5W - 26.5W (M)
flux: 2970lm - 3077lm
CCT: adjustable: 2700K, 3000K, 4000K (42)¹
control: Phase-Control (PH)

¹Possibility to change the colour temperature using integrated switch.

accessory

- 81245-12 - PIPER 130 top
- 81246-12 - PIPER 150 top



Not applicable to the vert version



- top finishes**
- white -13 ○
 - black -12 ●
 - burgundy -86 ●
 - terracotta -83 ●
 - sandy -87 ●
 - taupe -82 ●
 - grey -84 ●
 - gold -19 ●
- luminaire finishes**
- black -12 ●

main material
aluminium | PC | steel (top)

EVEN ILLUMINATION
IN A REFINED FORM

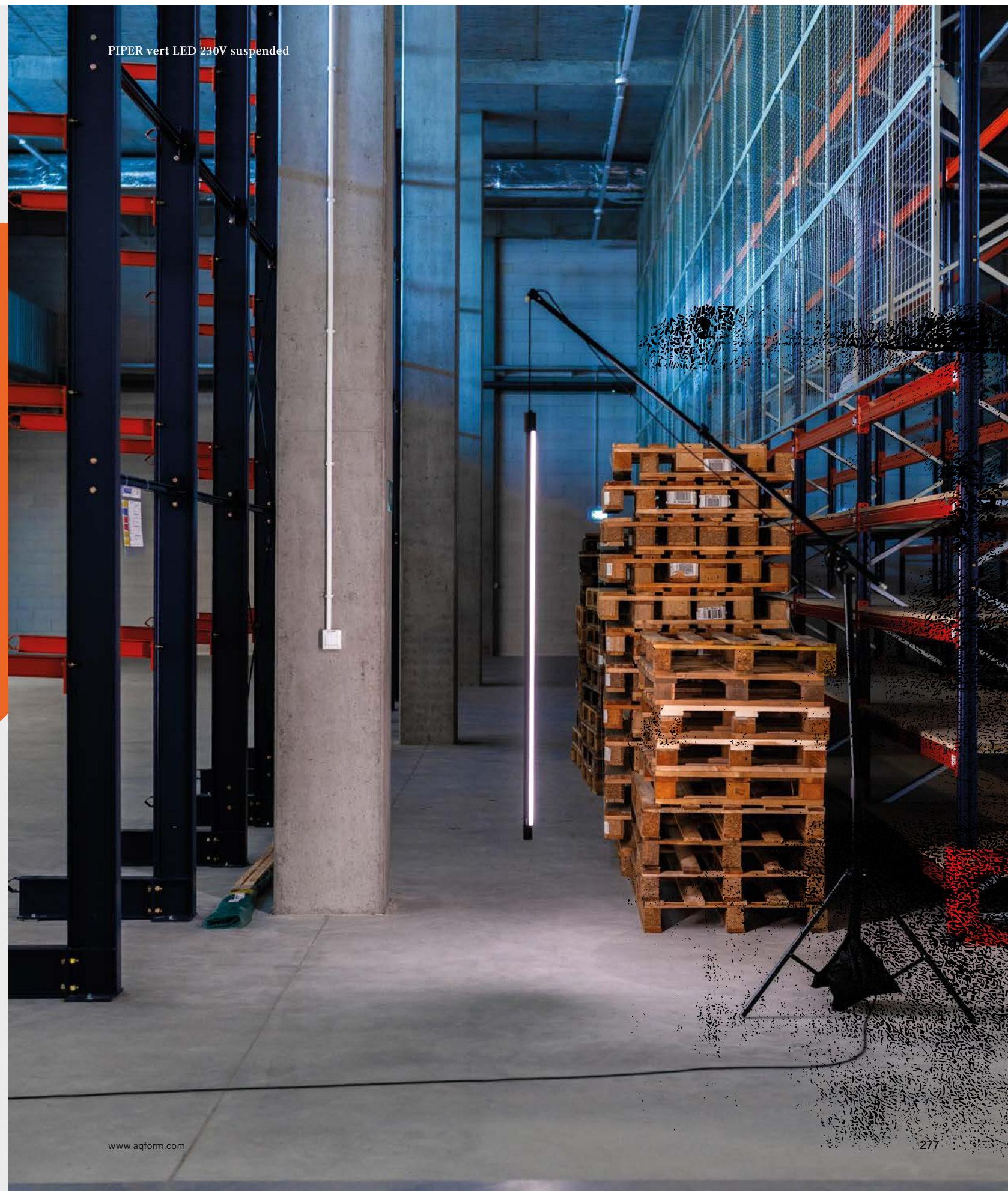

QRLED next suspended

Baba Jacquet, Gent

QRLED next

Despite its compact size, the QRLED next collection boasts impressive power and exceptional efficiency. Its minimalist design and refined form make QRLED next a subtle ally of modern interiors. Thanks to its outstanding performance, it successfully addresses the diverse needs of both private and public spaces.

QRLED NEXT

FUNCTIONAL AND MODERN

recessed p. 062-066
surface p. 132-136
suspended
Track p. 408
systems p. 584



QRLED next

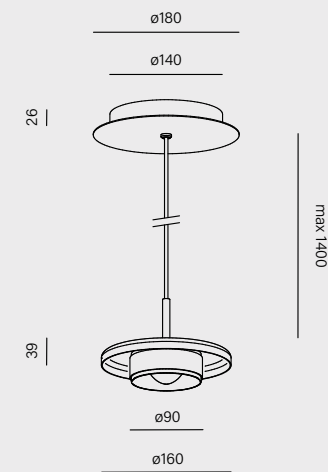

cat. n°	
59931-M930-W3-00-12	
power:	6W (L) 9W (M)
flux:	834lm - 1134lm
optics:	52° (W)
CCT:	2700K (27) 3000K (30) 4000K (40)
control:	ON/OFF (00) Phase control (PH) DALI (DA)



luminaire finishes

- white -13 ○
- black -12 ●
- burgundy -86 ●
- terracotta -83 ●
- sandy -87 ●
- taupe -82 ●
- grey -84 ●
- gold -19 ●
- mix -06 ●

main material

aluminium | steel | optical glass | PPE+PA



www.aqform.com

Data for standard LED product is shown for LED light source 3000K. Other variants are available on our website.

279

Awarded products: QRLED next family



278

Design: Rexel

KLIVA

KLIVA is an aluminium luminaire with a compact form and bold geometry. The LED version provides strong, precise light, making it suitable for illuminating tables or highlighting selected elements of a space. The E27 variant allows for the use of decorative light sources, giving the luminaire a more atmospheric character.



KLIVA LED | E27

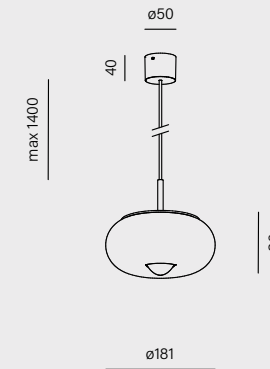

cat. n°

59938-M930-W3-00-12

power:	6W (L) 9W (M)
flux:	834lm - 1134lm
optics:	52° (W)
CCT:	2700K (27) 3000K (30) 4000K (40)
control:	ON/OFF (00) Phase-Control (PH) DALI (DA)

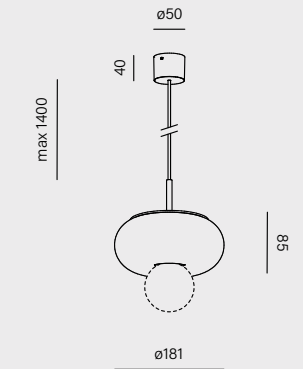

cat. n°

59941-E000-00-PH-12

power:	max: 50W
control:	Phase-Control (PH)



light source not included

luminaire finishes

- white -13 ○
- black -12 ●
- brutal -85 ○
- burgundy -86 ●
- terracotta -83 ●
- sandy -87 ●
- taupe -82 ●
- grey -84 ●
- gold -19 ●

main material

aluminium | steel | optical glass (LED version)



recessed p. 090
 surface p. 148-152
suspended
 Track p. 412-414
 wall p. 470
 systems p. 584

TRIBA_



TRIBA is more than just a shape, it is modern technology enclosed in a decorative form. The luminaire features hybrid optics and an extended shielding angle, offering outstanding performance without compromising light quality. A wide power range, two diameters, several lengths and mounting options make TRIBA easy to adapt to the individual needs of any interior.

TRIBA LED mini | midi

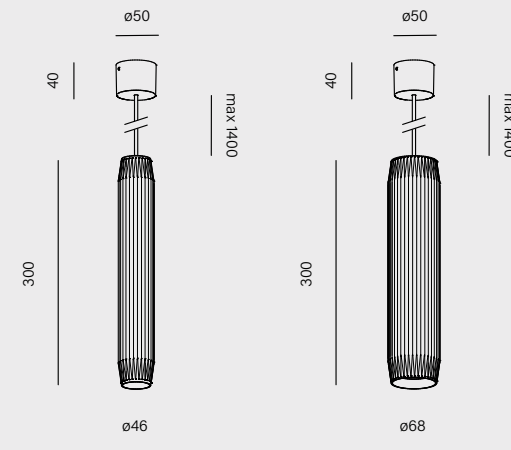

	cat. n°	cat. n°
	59914-M930-WB-00-82	59916-M930-WB-00-82
power:	4.5W (M)	8.5W (M)
flux:	543lm	1149lm
optics:	20° (S_) 41° (W_)	18° (S_) 35° (F_) 50° (W_)
CCT:	2700K (27) 3000K (30) 4000K (40)	
control:	ON/OFF (00)	ON/OFF (00) Phase-Control (PH) DALI (DA)

accessory



Not applicable to the E27 version



TRIBA midi GU10

TRIBA midi E27

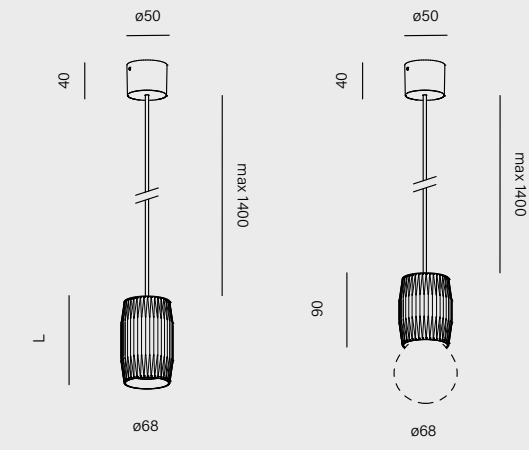

	length	cat. n°	cat. n°
	120mm	57667-G000-00-PH-82	59915-E000-00-PH-82
	300mm	57666-G000-00-PH-82	
power:	max: 50W		
control:	Phase-Control (PH)		

light source not included

TRIBA GU10 includes a ring in the colour of the luminaire

- | ring finishes | luminaire finishes |
|--------------------|--------------------|
| only for TRIBA LED | |
| white -_W | white -13 |
| black -_B | black -12 |
| natural -_N | brutal -85 |
| burgundy -_U | burgundy -86 |
| terracotta -_R | terracotta -83 |
| sandy -_D | sandy -87 |
| taupe -_T | taupe -82 |
| grey -_A | grey -84 |
| gold -_G | gold -19 |

The brutal (-85) color variant of the luminaires can only be ordered with neutral optics (_N)

main material
aluminium





A fusion of form
and function

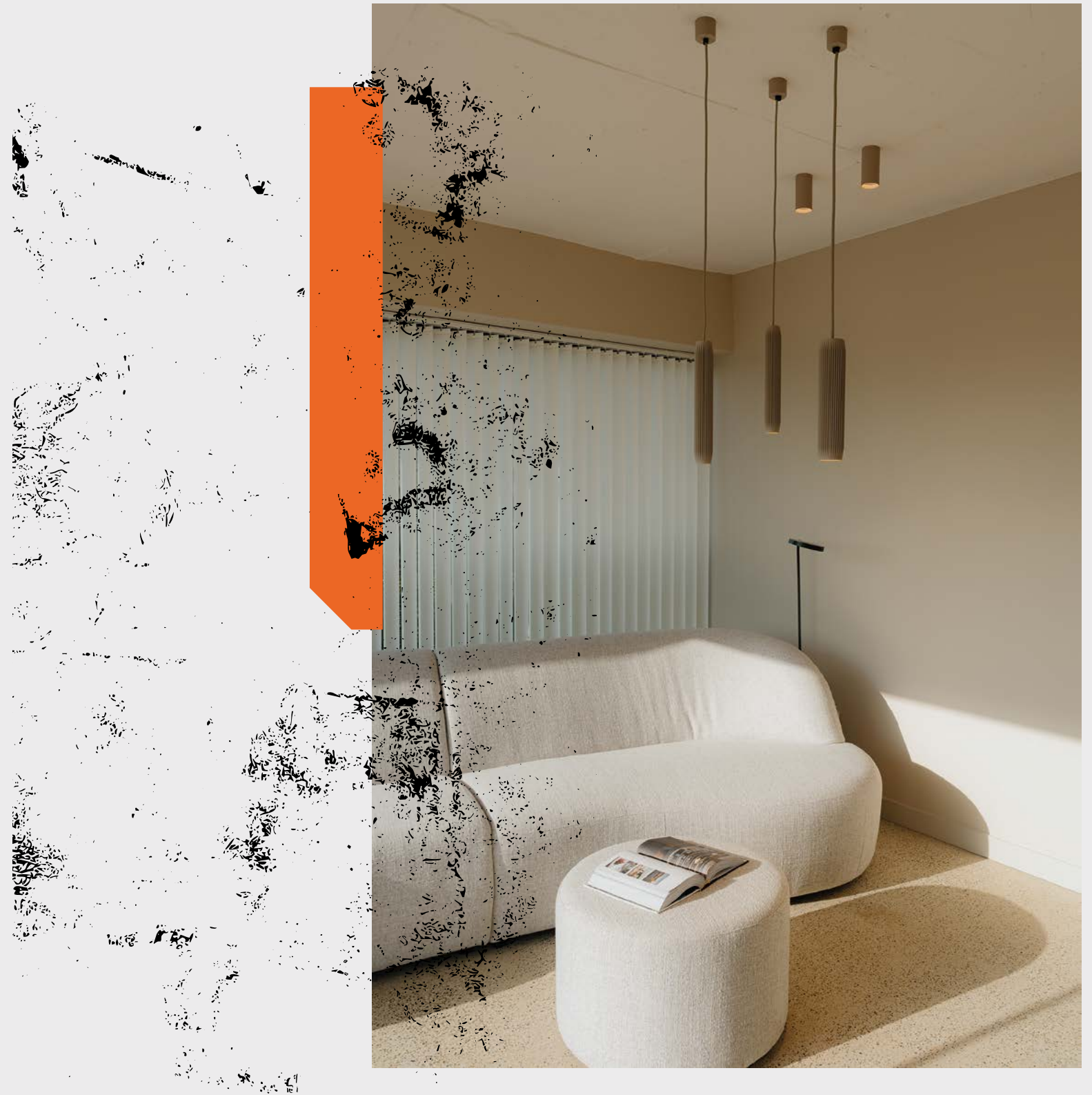

MODERN GLASS mini

MODERN GLASS mini LED suspended

MODERN GLASS mini is an aesthetic accent that, especially when grouped, not only adds elegance to an arrangement but also effectively illuminates tables and side tables. The long, slender shades add sophistication to the interior while providing excellent task lighting. The luminaire offers performance typical of architectural lighting, while maintaining a decorative character.

accessory

honeycomb



glass finishes

PP

PS



new

ring finishes

white -_W

black -_B

burgundy -_U

terracotta -_R

sandy -_D

taupe -_T

grey -_A

gold -_G

luminaire finishes

white -13

black -12

burgundy -86

terracotta -83

sandy -87

taupe -82

grey -84

gold -19

main material

aluminium | glass

While mounting you can decide where exactly the lighting module of the MODERN GLASS mini is set. If you want, it can be protruded a few centimeters beyond the luminaire.



MODERN GLASS mini LED PP | PS | PP SR | PS SR

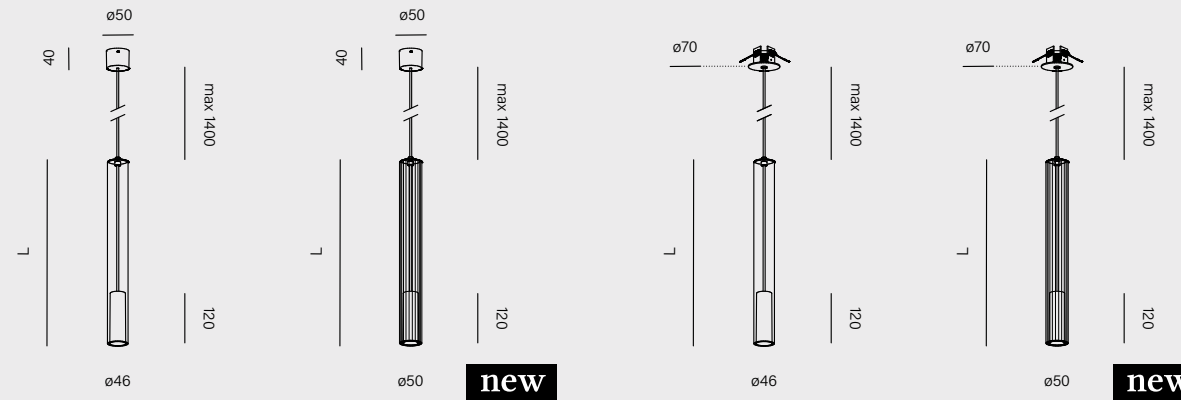

length	cat. n°	cat. n°	cat. n°	cat. n°
280mm	59880-M930-WB-00-12	59998-M930-WB-00-12	59877-M930-WB-00-12	59997-M930-WB-00-12
420mm	59881-M930-WB-00-12	59056-M930-WB-00-12	59878-M930-WB-00-12	51029-M930-WB-00-12
700mm	59882-M930-WB-00-12	59059-M930-WB-00-12	59879-M930-WB-00-12	59057-M930-WB-00-12
power:	4.5W (M)		4.5W (M) 4.5W (A)	
flux:	543lm			
optics:	20° (S) 41° (W)			
CCT:	2700K (27) 3000K (30) 4000K (40)			
CC driver:	-		(B) 500mA 8.6V	
control:	ON/OFF (00)		ON/OFF (00) require driver (CC)* DALI (DA)	

*Protection class, input voltage and IP rating for CC luminaires vary from above table.

suspended
wall p. 480
system p. 584

MODERN GLASS

FUNCTIONAL AND MODERN

MODERN GLASS mini PP LED SR suspended



MODERN GLASS mini PS LED SR suspended



MODERN GLASS mini proves that modern design with a decorative character can successfully go hand in hand with excellent technical performance. With the ability to play with colour finishes and lampshade lengths, MODERN GLASS mini can become a distinctive piece of jewellery for the interior.

Stylish jewellery
for your interior

MODERN GLASS Flared PS LED suspended

MODERN GLASS



MODERN GLASS was created in collaboration with the DECHEM studio, blending modernity with timeless elegance. Hand-blown glass creates a subtle decorative effect, while different shade shapes and finishes allow the luminaire to be tailored to the mood and character of the interior.

must have



suspended
wall p. 480
system p. 584



MODERN GLASS Tube LED SR

	cat. n°
	59969-M930-PW-00-12
power:	8.5W (M) 8.5W (A)
flux:	1149lm
optics:	Plain Transparent (PP) Plain Karo (PK) Plain Strip (PS) Plain White (PW)
CCT:	2700K (27) 3000K (30) 4000K (40)
CC driver:	(H) 250mA 34.2V
control:	ON/OFF (00) Phase-Control (PH) DALI (DA) require driver (CC)*



*Protection class, input voltage and IP rating for CC luminaires vary from above table.

Tube SR

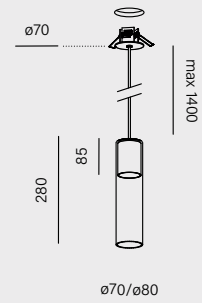

MODERN GLASS LED

lampshade	cat. n°
Tube	59975-M930-PS-00-12
Flared	59980-M930-PS-00-12
Barrel	58848-M930-PS-00-12
power:	8.5W (M)
flux:	1149lm
optics:	Plain Transparent (PP) Plain Karo (PK) Plain Strip (PS)* Plain White (PW)
CCT:	2700K (27) 3000K (30) 4000K (40)
control:	ON/OFF (00) Phase-Control (PH)



* only for Flared and Tube

Tube

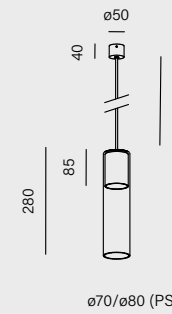

Flared

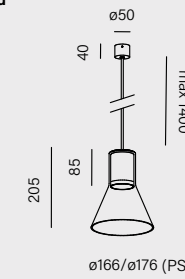

Barrel

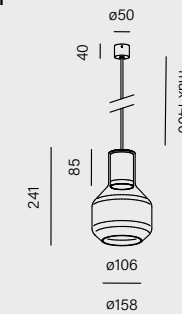

glass finishes



luminaire finishes

- white -13
- black -12
- burgundy -86
- terracotta -83
- sandy -87
- taupe -82
- grey -84
- gold -19

main material

aluminium | glass



The MODERN GLASS collection works well above tables, counters and in lounge areas, where not only light but also aesthetics matter. A variety of glass shapes, from cylindrical to conical, allows diverse yet cohesive compositions to be created.

Private house in hampton style, Zielona Góra



MODERN GLASS Barrel PK LED suspended

LIGHT AS THE
JEWELLERY
OF THE INTERIOR

FLYING BALL arc PW x3 LED suspended

Hygge Hotel, Opole

FLYING BALL

FLYING BALL impresses not only with its original form but also with strong performance. It is an example of a product where aesthetics go hand in hand with technology. The milky glass spheres are a timeless feature in modern interiors, emitting softly diffused light that is gentle on the eyes.

Awarded products: FLYING BALL arc suspended



Awarded products: all family



suspended

FLYING BALL

FUNCTIONAL AND MODERN



FLYING BALL arc PW x3 LED

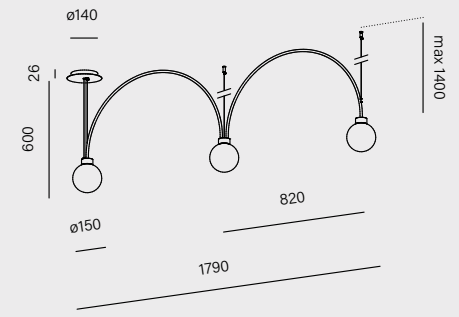

cat. n°	
59866-M930-PW-00-12	
power:	18.5W (L) 26.5W (M)
flux:	2502lm - 3402lm
CCT:	2700K (27) 3000K (30) 4000K (40)
control:	ON/OFF (00)

luminaire finishes

- white -13
- black -12
- burgundy -86
- terracotta -83
- sandy -87
- taupe -82
- grey -84
- gold -19

main material

aluminium | steel | glass



MODERN BALL PW x3 LED suspended | SQUARES next 50x2 LED trimless recessed

Private apartment, Zielona Góra

MODERN BALL

Glass is one of the most traditional materials in the lighting industry. The sphere is also one of the most timeless shapes. The MODERN BALL family combines classic design with softly diffused light that is gentle on the eyes. The beauty of the collection was crafted by the DECHEM design studio while the technology was developed by AQForm engineers.



must have



MODERN BALL PW LED x3 | x4 asymmetry

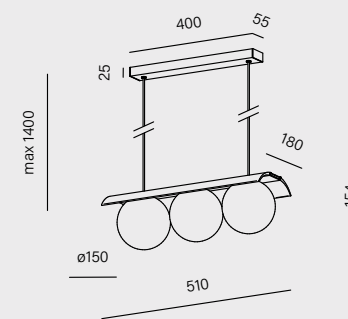

cat. n°

59779-M930-PW-00-12

power: 17.5W (L) | 26W (M)

flux: 2382lm - 3291lm

CCT: 2700K (27) | 3000K (30) | 4000K (40)

control: ON/OFF (00) | switchDIM (SW) | DALI (DA)

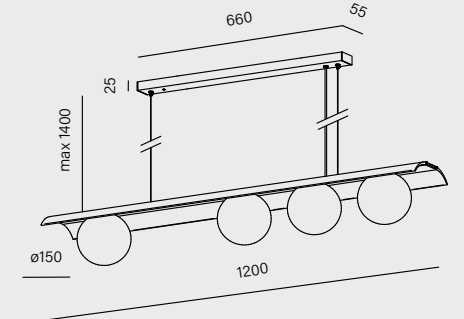

cat. n°

59823-M930-PW-00-12

power: 23W (L) | 34.5W (M)

flux: 3176lm - 4388lm

luminaire finishes

- white -13 ○
- black -12 ●
- burgundy -86 ●
- terracotta -83 ●
- sandy -87 ●
- taupe -82 ●
- grey -84 ●
- gold -19 ●

main material

aluminium | glass



MODERN BALL simple



MODERN BALL simple PW LED mini | mini SR

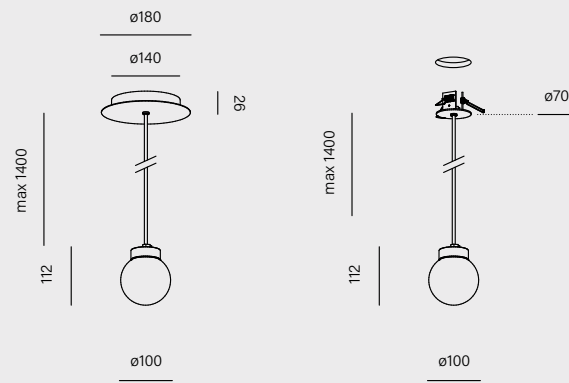

cat. n°		cat. n°	
59876-M930-PW-00-12		59875-M930-PW-00-12	
power: 4W (L) 6W (M)		4W (L) 6W (M) 6W (A)	
flux: 580lm - 794lm			
CCT: 2700K (27) 3000K (30) 4000K (40)			
CC driver: -		(D) 350mA 16.7V	
control: ON/OFF (00)		ON/OFF (00) DALI (DA) require driver (CC)*	

*Protection class, input voltage and IP rating for CC luminaires vary from above [table](#).

MODERN BALL simple is a fusion of classic form and modern LED technology. The milky glass globe emits a soft, evenly distributed light that is gentle on the eyes, giving the interior a harmonious character. This luminaire combines timeless aesthetics with high functionality.

MODERN BALL simple PW LED midi | midi SR | maxi | maxi SR

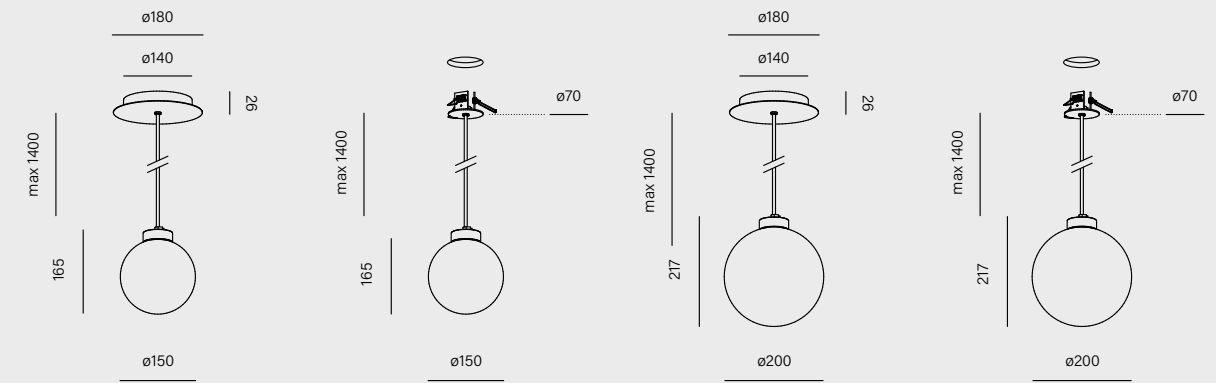

cat. n°		cat. n°		cat. n°		cat. n°	
59835-M930-PW-00-12		59836-M930-PW-00-12		59873-M930-PW-00-12		59874-M930-PW-00-12	
power: 6W (L) 9W (M)		6W (L) 9W (M) 9W (A)		8W (L) 11.5W (M)		8W (L) 11.5W (M) 11.5W (A)	
flux: 834lm - 1134lm		834lm - 1134lm		1173lm - 1617lm		1173lm - 1617lm	
CCT: 2700K (27) 3000K (30) 4000K (40)				(K) 350mA 32.8V			
CC driver: -		(G) 350mA 25.1V		-		(K) 350mA 32.8V	
control: ON/OFF (00) DALI (DA)		ON/OFF (00) DALI (DA) require driver (CC)*		ON/OFF (00)		ON/OFF (00) DALI (DA) require driver (CC)*	

*Protection class, input voltage and IP rating for CC luminaires vary from above [table](#).



luminaire finishes

- white -13
- black -12
- burgundy -86
- terracotta -83
- sandy -87
- taupe -82
- grey -84
- gold -19

main material

aluminium | glass | steel (not for SR)

surface p. 178
suspended
Track p. 448
upright p. 516
systems p. 584



LATERIA ITALIA	
BOL	2,80
BOLLEN	4,80
BOLLEN	5,80
BOLLEN	6,80
BOLLEN	7,50
AGROOM	0,80

A GLASS FORM
WITH TIMELESS
CHARACTER



The suspended version of MODERN BALL simple works well above a dining table, reception counter or in a restaurant where evenly distributed light is needed to illuminate both the tabletop and the surrounding area. Its uniform emission provides a pleasant user experience and a subtle visual effect.



PET mini horiz

PET mini horiz features deeply recessed PET mini modules and a honeycomb louvre that further reduces glare and helps direct light precisely onto the tabletop surface. The option of combining different body and optic colours supports alignment with project requirements. Two length variants allow a version best suited to the size of the table or island to be selected, ensuring optimal illumination and a cohesive visual effect. As a result, PET mini horiz offers a well-thought-out, easy-to-select solution in terms of both performance and aesthetics.

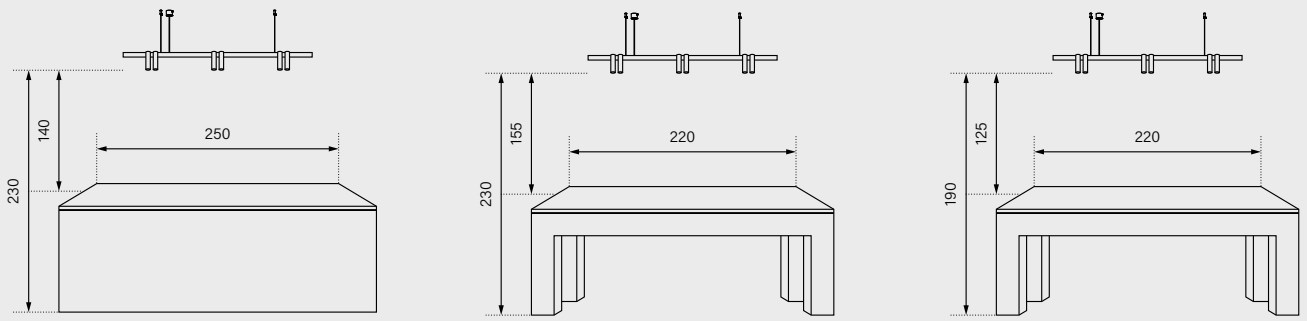

Above a large island or table, installation height of 220–240 cm for the best effect.

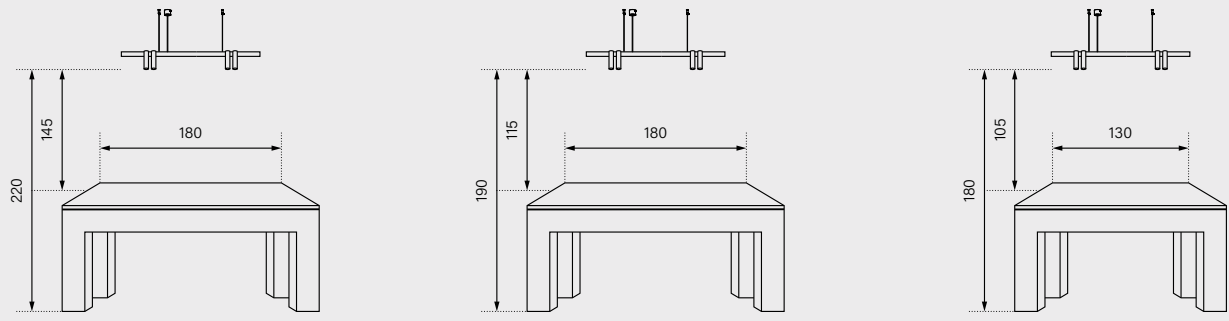

Above a large island or table, installation height of 220–240 cm for the best effect.

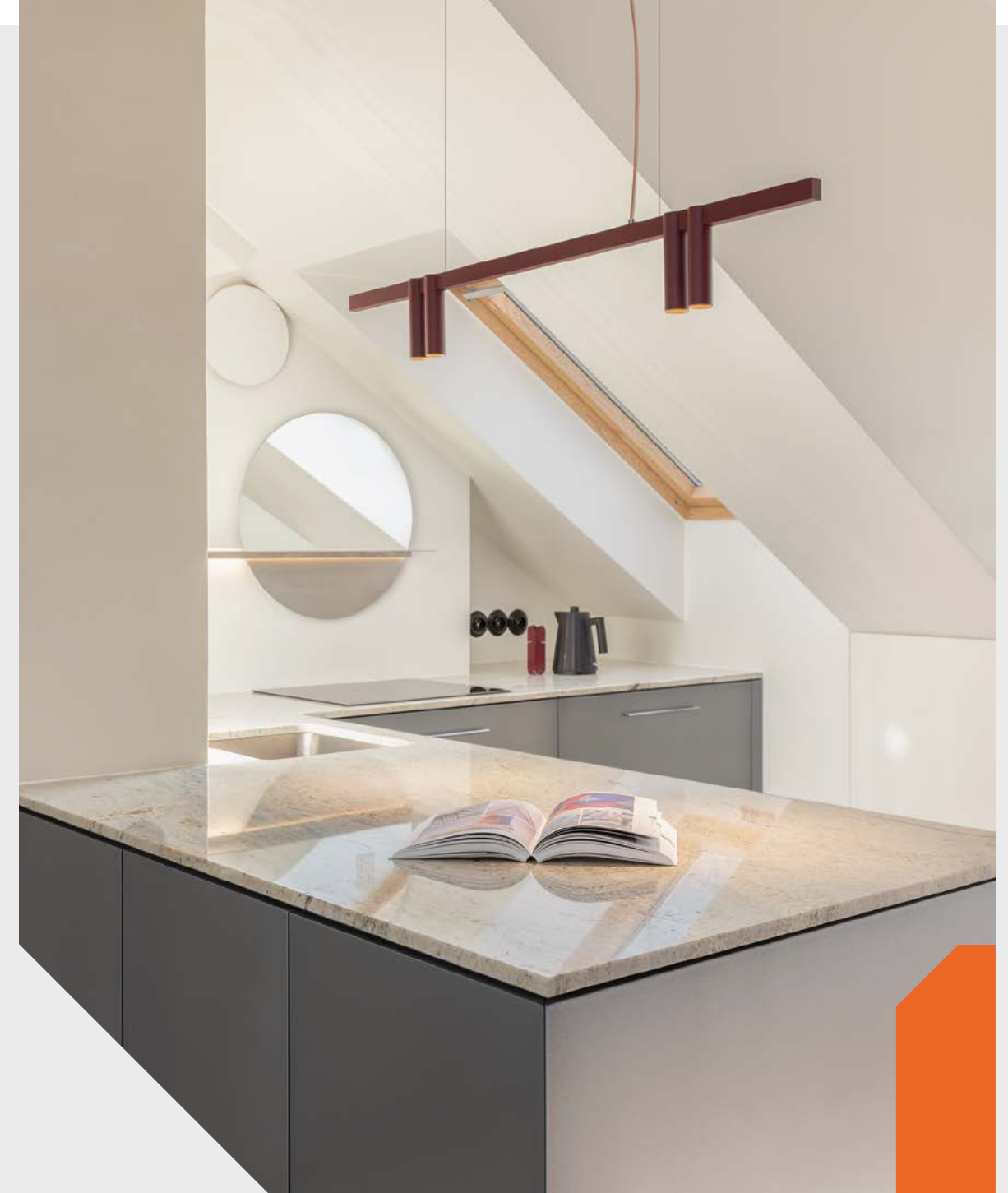

PET mini _horiz

PET mini horiz was designed for precise illumination of tables and worktops. Available in x4 and x6 versions, it combines refined optics with body proportions that emphasise the luminaire's linear character and its alignment with the entire PET family.

recessed p. 092
surface p. 162-164
suspended
Track p. 416-420
wall p. 472
exterior p. 538
systems p. 584

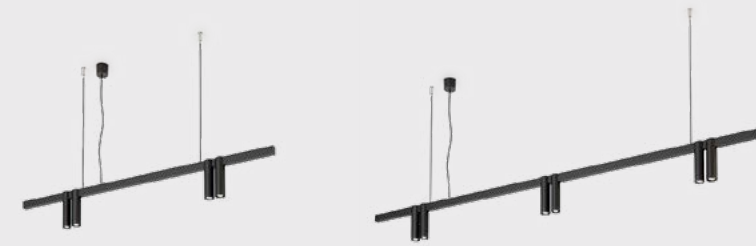

PET mini horiz LED x4 | x6

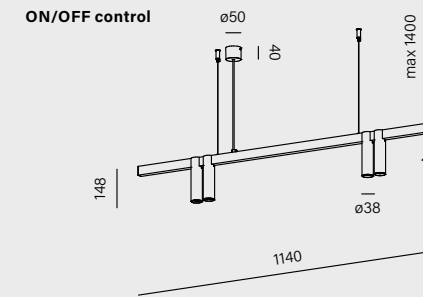

cat. n°

59946-M930-WB-00-12

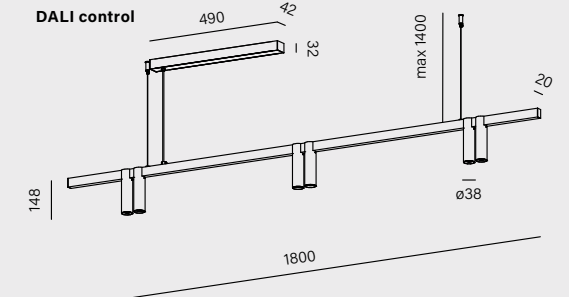

cat. n°

59947-M930-WB-00-12

power:	17W - 26W (M) 25.5W - 38.5W (H)
flux:	2172lm - 3987lm
optics:	41° (W)
CCT:	2700K (27) 3000K (30) 4000K (40)
control:	ON/OFF (00) DALI (DA)

accessory

ON/OFF control



DALI control



81310-12 - PET mini horiz rounded end cup



When purchasing the on/off fixture in the H power version, a canopy in the DALI version will also be included.



ring finishes

- white -_W
- black -_B
- burgundy -_U
- terracotta -_R
- sandy -_D
- taupe -_T
- grey -_A
- gold -_G

luminaire finishes

- white -13
- black -12
- burgundy -86
- terracotta -83
- sandy -87
- taupe -82
- grey -84
- gold -19

main material

aluminium

recessed p. 092
 surface p. 162-164
suspended
 Track p. 416-420
 wall p. 472
 exterior p. 538
 systems p. 584



PET LED
 mini | midi | maxi

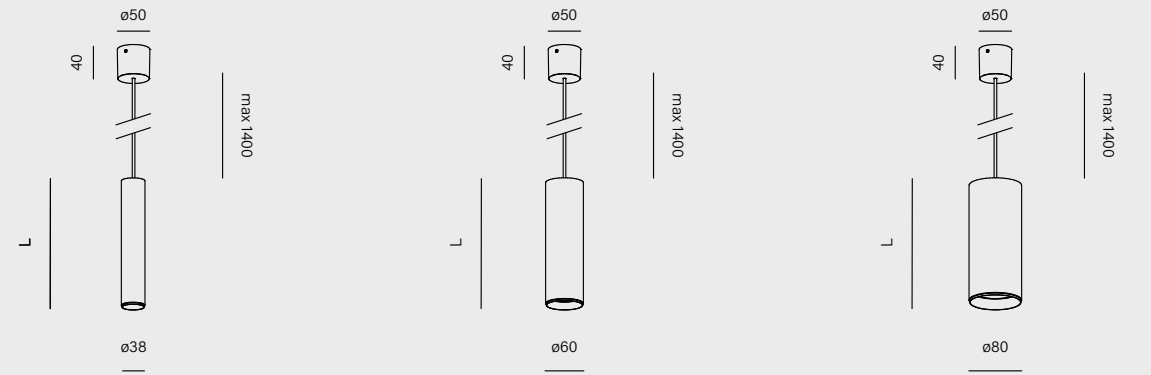

length	cat. n°	cat. n°	cat. n°
200mm	59772-M930-WB-00-12	59769-M930-WB-00-12	59775-M930-WB-00-12
320mm	59773-M930-WB-00-12	59770-M930-WB-00-12	59776-M930-WB-00-12
power:	4.5W (M)	8.5W (M)	11.5W (L) 17W (M)
flux:	543lm	1149lm	1617lm - 2261lm
optics:	20° (S) 41° (W)	18° (S) 35° (F) 50° (W)	19° (S) 32° (F) 63° (W)
CCT:	2700K (27) 3000K (30) 4000K (40)		
CC driver:	(B) 500mA 8.6V	(H) 250mA 34.2V	
control:	ON/OFF (00)		ON/OFF (00) Phase-Control (PH) DALI (DA)

accessory
 honeycomb



- ring finishes**
- white -_W ○
 - black -_B ●
 - natural -_N ●
 - burgundy -_U ●
 - terracotta -_R ●
 - sandy -_D ●
 - taupe -_T ●
 - grey -_A ●
 - gold -_G ●
- luminaire finishes**
- white -13 ○
 - black -12 ●
 - brutal -85 ●
 - burgundy -86 ●
 - terracotta -83 ●
 - sandy -87 ●
 - taupe -82 ●
 - grey -84 ●
 - gold -19 ●

The brutal (-85) color variant of the luminaires can only be ordered with neutral optics (_N)

main material
 aluminium

PET



PET LED SR
 mini | midi

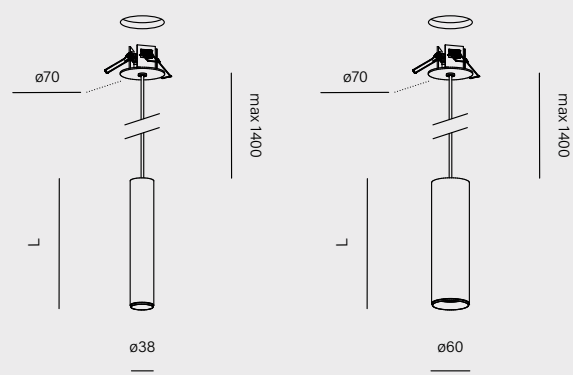

length	cat. n°	cat. n°
200mm	59829-M930-WB-00-12	59826-M930-WB-00-12
320mm	59830-M930-WB-00-12	59827-M930-WB-00-12
power:	4.5W (M) 4.5W (A)	8.5W (M) 8.5W (A)
flux:	543lm	1149lm
optics:	20° (S) 41° (W)	18° (S) 35° (F) 50° (W)
CCT:	2700K (27) 3000K (30) 4000K (40)	
CC driver:	(B) 500mA 8.6V	(H) 250mA 34.2V
control:	ON/OFF (00) Phase-Control (PH)* DALI (DA)* require driver (CC)*	

*for PET midi

*Protection class, input voltage and IP rating for CC luminaires vary from above [table](#).

PET is a suspended luminaire with a distinctive cylindrical body and refined optics. It is available in several sizes and delivers precise light with low glare and pleasant visual effect. The variety of versions allows a model suited to the scale and function of the interior to be selected.



SWING next recessed | RAFTER points section recessed | MODERN BALL table



Thanks to its varied diameters and lengths, PET allows cohesive lighting compositions to be created, from single points above a table to rhythmic arrangements in restaurants or office spaces. It is a timeless form that combines light precision with application flexibility and visual lightness.

PRECISION AND FLEXIBILITY IN A LIGHT FORM

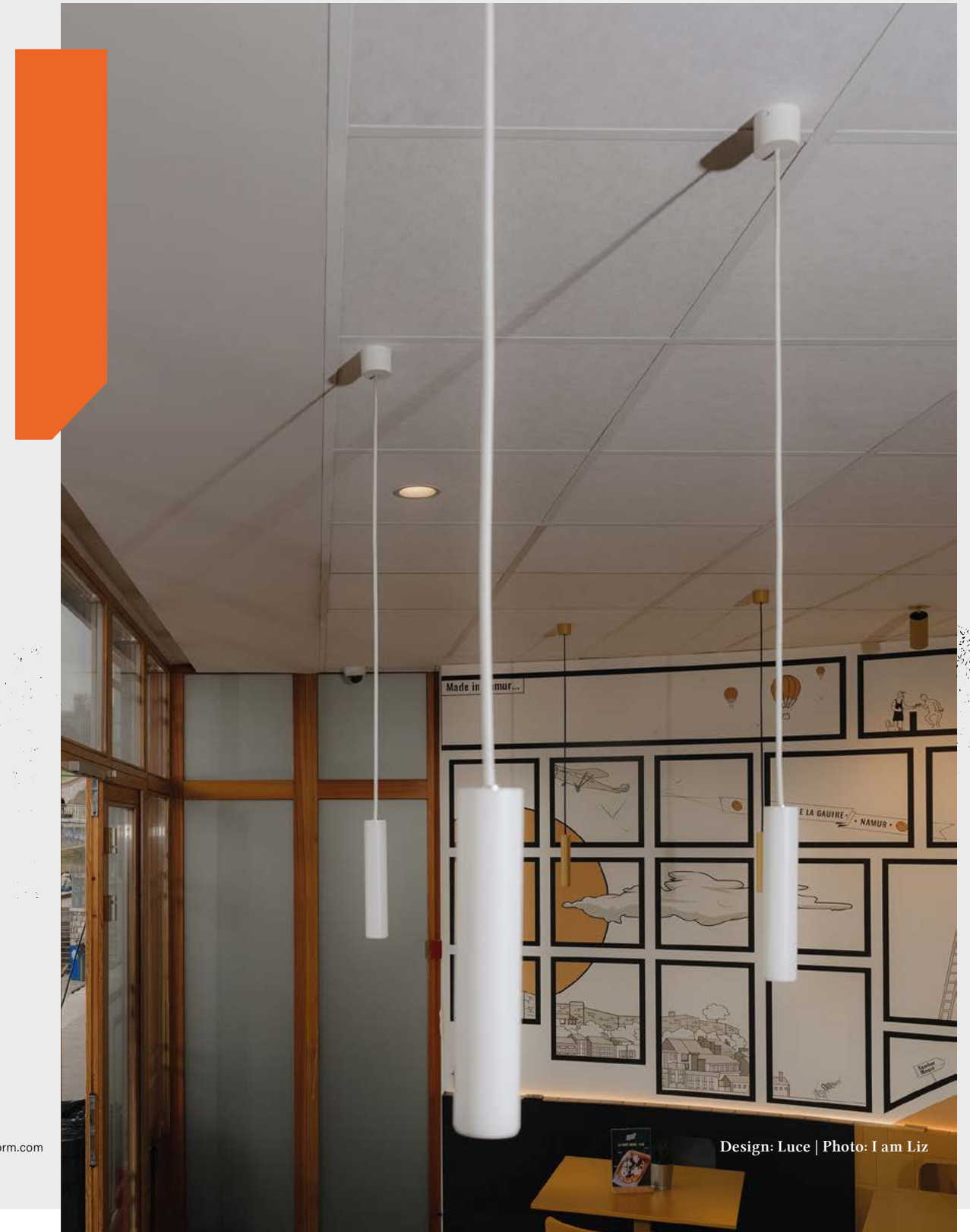

RING_dot

The suspended version of RING dot is an elegant luminaire with a distinct identity. Light reflected from the inner surface of the shade provides a pleasant, evenly distributed glow, while the luminaire's characteristic geometry adds lightness and harmony to the interior. It performs well positioned above a table or meeting area, delivering uniform, glare-free lighting.



Photo: I Am Liz



RING dot LED midi | maxi

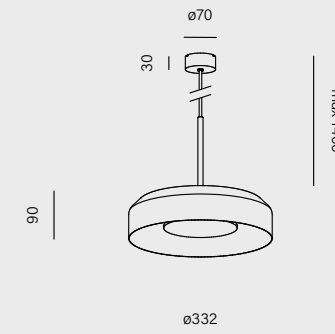

cat. n°

59904-M930-DW-PH-12

power:

14.5W (M)

flux:

2168lm¹

CCT:

2700K (27) | 3000K (30) | 4000K (40)

control:

Phase-Control (PH)

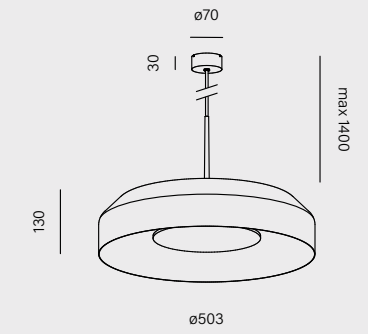

cat. n°

59903-M930-DW-PH-12

power:

25W (M)

flux:

3833lm¹

CCT:

2700K (27) | 3000K (30) | 4000K (40)

control:

Phase-Control (PH) | DALI (DA)



¹ Luminaires with a colored interior finish emit a lower luminous flux and are intended for decorative use.



inner finishes

- white -_W ○
- terracotta -_R ●
- sandy -_D ●
- taupe -_T ●
- grey -_A ●
- gold -_G ●

luminaire finishes

- white -13 ○
- black -12 ●
- burgundy -86 ●
- terracotta -83 ●
- sandy -87 ●
- taupe -82 ●
- grey -84 ●
- gold -19 ●

main material

aluminium | steel | PC

BLOS round LED suspended

BLOS round

The suspended version of BLOS round combines elegant design with enhanced durability. It emits strong, evenly distributed light, making it suitable for general lighting. This aesthetically refined luminaire subtly highlights the character of the interior while ensuring long-lasting reliability.



surface p.198
suspended
Track p.446

BLOS

FUNCTIONAL AND MODERN

BLOS round LED

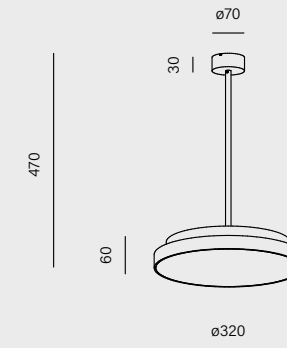

cat. n°

59864-M930-D9-00-12

power: 11.5W (L) | 23W (M)

flux: 1725lm - 3268lm

CCT: 2700K (27) | 3000K (30) | 4000K (40)

control: ON/OFF (00) | Phase-Control (PH)¹ | switchDIM (SW) | DALI (DA) | Aqsmart (DB) | Occupation Sensor (OS)²



¹ available only for L version

² Control system OS integrates a microwave motion sensor for automatic presence detection. It supports tri-level dimming, corridor function, and configurable parameters such as detection area, hold-time, daylight threshold, and standby dimming level.

accessory

81300 - BLOS round PRO diffuser set



luminaire finishes

- white -13
- black -12
- burgundy -86
- terracotta -83
- sandy -87
- taupe -82
- grey -84
- gold -19

main material

PC | aluminium

BIG SIZE

The suspended BIG SIZE next round LED was created for spacious, high-ceiling interiors. It provides a large amount of light emitted by big surface. Available in several sizes and diffuser versions, the luminaire can be matched to the character and requirements of the space.

BIG SIZE next round LED opal | PRO

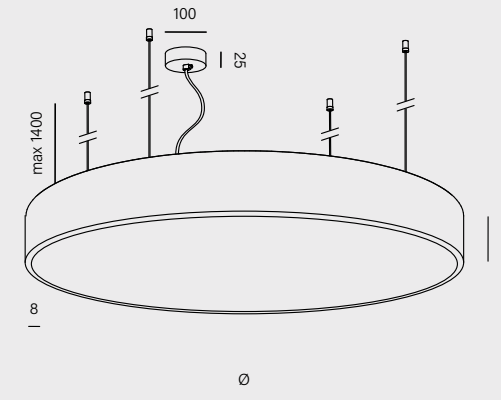

diameter	cat. n°
ø660mm	50259-A930-D9-00-12
ø960mm	50261-A930-D9-00-12
ø1220mm	50263-A930-D9-00-12
power:	70W - 250W (M) 23W - 130W (A)
flux:	3263lm - 19624lm
optics:	opal (D9) microprism (D5)
CCT:	2700-6500K (62) ¹ 3000K (30) 4000K (40)
control:	ON/OFF (00) switchDIM (SW) DALI (DA) AQsmart (DB)



¹A Tunable-White option available only for opal diffuser (D9) | ²only for microprism (D5)

covers comparison

regular (opal)



PRO (microprism)

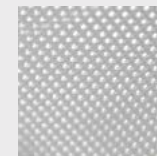

luminaire finishes

- white -13 ○
- black -12 ●

main material

aluminium | PC (opal) | PMMA (microprism)

recessed p. 100
surface p. 202
suspended

BIG SIZE

FUNCTIONAL AND MODERN

THIN TUBE_

The suspended version of THIN TUBE combines a slim form with high luminous efficacy. It provides even illumination of countertops and workstations, delivering a clean line of light with no visible LED points. The luminaire is available in several lengths.

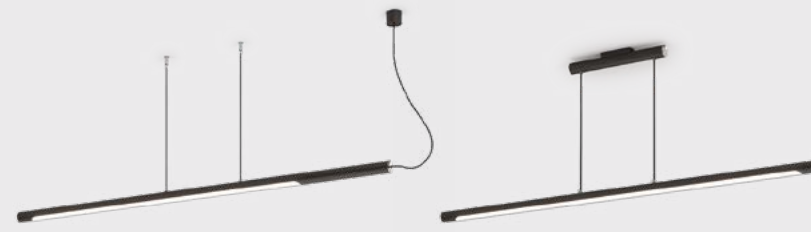

THIN TUBE LED asymmetry | central

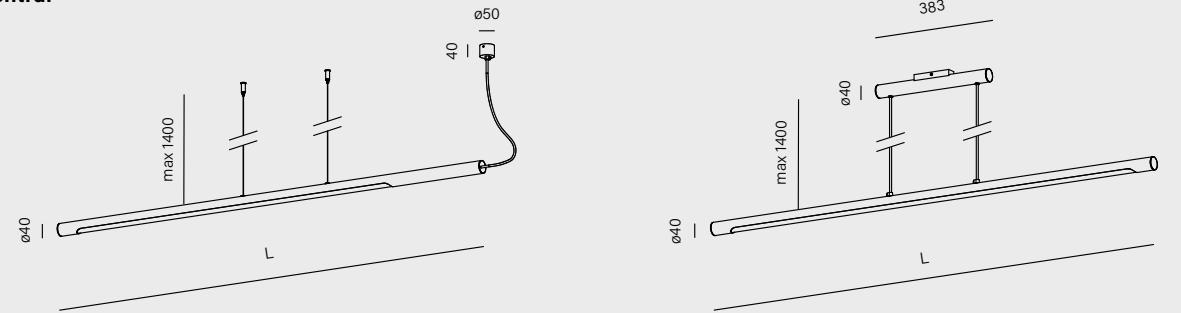

length	cat. n°	length	cat. n°
1223mm	50581-M930-D9-00-12	963mm	50572-M930-D9-00-12
1503mm	50582-M930-D9-00-12	1523mm	50571-M930-D9-00-12
1783mm	50583-M930-D9-00-12		

power: 13W - 21.5W (L) | 26W - 43W (M)
flux: 1746lm - 5820lm
CCT: 2700K (27) | 3000K (30) | 4000K (40)
control: ON/OFF (00) | switchDIM (SW) | DALI (DA)

luminaire finishes

- white -13
- black -12
- burgundy -86
- terracotta -83
- sandy -87
- taupe -82
- grey -84
- gold -19

main material
aluminium | PMMA





A LINE OF PRECISE
LIGHT IN A SLIM FORM

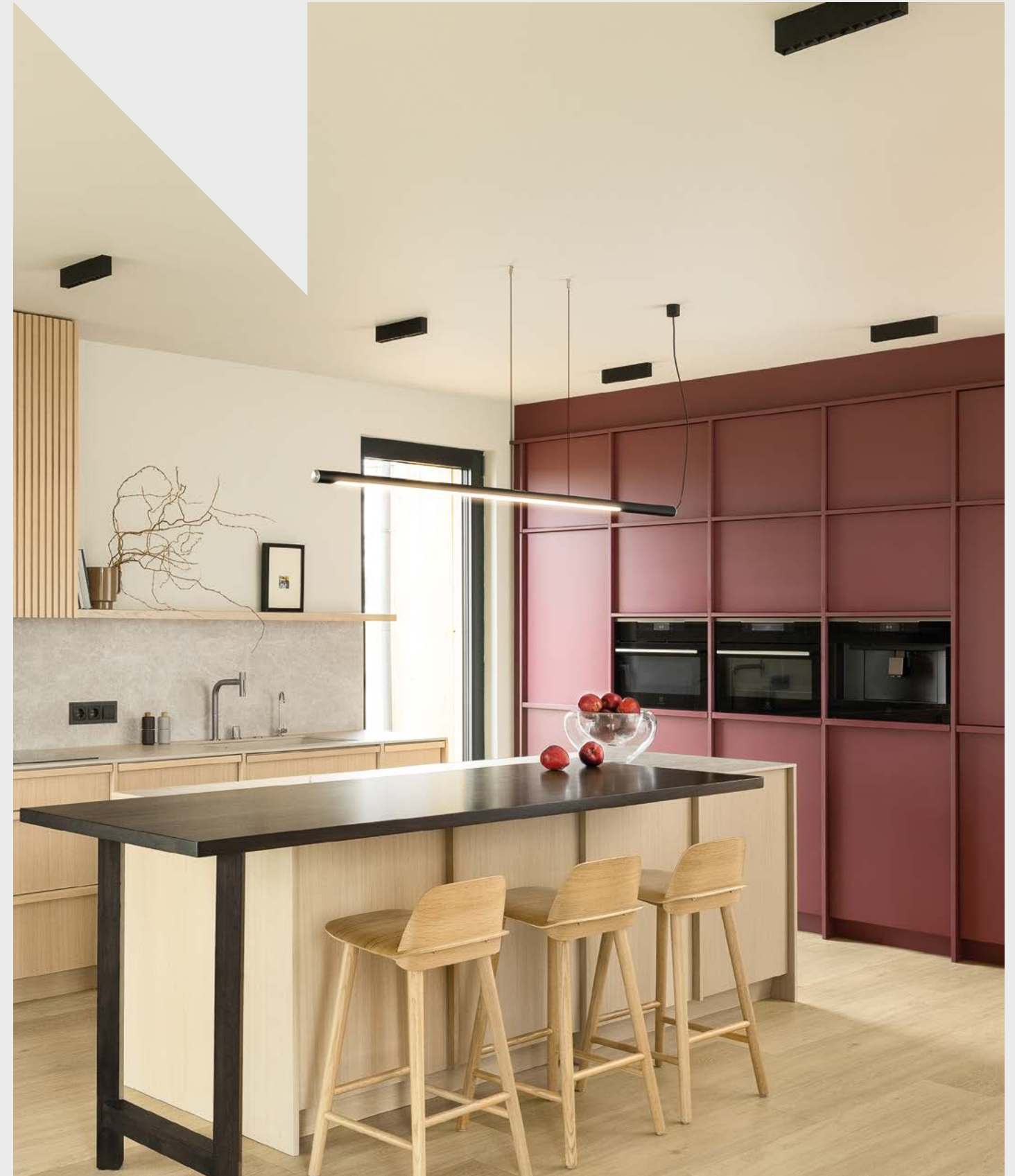

SET RAW mini

SET RAW is a luminaire with a balanced, restrained form, designed with ergonomics and work requirements in mind. It creates an even line of light above desks and tables, organising the space and supporting optimal conditions for everyday tasks.



SET RAW mini LED

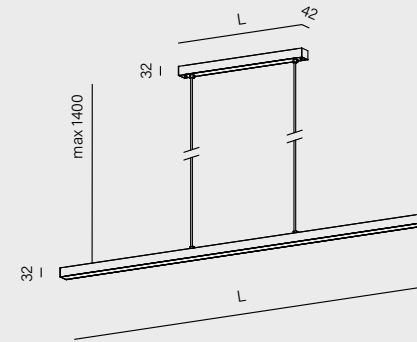

length	headliner	cat. n°
580mm	320mm	50359-M930-D9-00-12
870mm	490mm	50361-M930-D9-00-12
1150mm	490mm	50363-M930-D9-00-12
1430mm	490mm	50365-M930-D9-00-12
1710mm	490mm	50367-M930-D9-00-12
1990mm	700mm	50369-M930-D9-00-12
power:	17W - 60W (M)	
flux:	2328lm - 8148lm	
CCT:	2700K (27) 3000K (30) 4000K (40)	
control:	ON/OFF (00) switchDIM (SW) ¹ DALI (DA) ¹ Aqsmart (DB) ¹	

¹ from length 870mm



luminaire finishes

- white -13 ○
- black -12 ●
- brutal -85 ●

main material

aluminium | PMMA

LENS LINE

LENS LINE is a linear luminaire that combines compact dimensions with high luminous efficacy. Integrated lenses create a distinctive lighting effect while ensuring even illumination of the space. Depending on the version, it can be used as general or task lighting, for example above a worktop.



recessed p. 118
surface p. 220
suspended



LENS LINE section LED

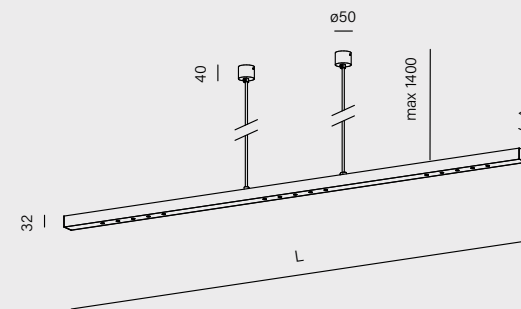

length	cat. n°
960mm	50282-M930-W3-00-12
1490mm	50284-M930-W3-00-12
2020mm	50286-M930-W3-00-12
power:	7W - 14.5W (L) 14.5W - 29.5W (M)
flux:	923lm - 3545lm
optics:	26° (F) 54° (W)
CCT:	2700K (27) 3000K (30) 4000K (40)
control:	ON/OFF (00) switchDIM (SW) DALI (DA) Aqsmart (DB)



Information about dimensions of optics placement within the luminaire are on page 642.



luminaire finishes

- white -13 ○
- black -12 ●
- brutal -85 ●

main material

aluminium

MIXLINE

G 01 ^
 G 05 ^
 RTG 1 ^
 RTG 2 >

Design: Maka Studio, Photo: Tom Kurek

Debowia Clinik, Kwidzyn

MIXLINE LED suspended

recessed p. 116
 surface p. 214
suspended
 system p. 606



MIXLINE LED - | INV

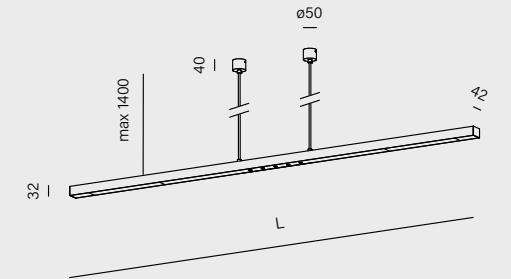
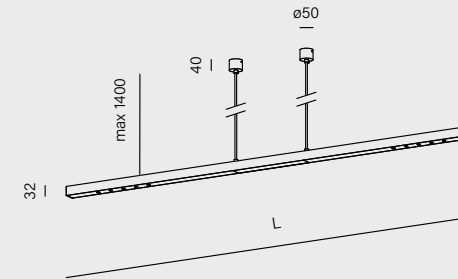

length	cat. n°	length	cat. n°
1600mm	50438-M930-W3-00-12	1670mm	50441-M930-W3-00-12
1880mm	50439-M930-W3-00-12	1920mm	50442-M930-W3-00-12
2160mm	50440-M930-W3-00-12		
power:	16W - 33W (M)		21W - 24.5W (M)
flux:	2064lm - 4392lm		2778lm - 3228lm
optics:	26° (F) 54° (W)		
CCT:	2700K (27) 3000K (30) 4000K (40)		
control:	ON/OFF (00) switchDIM (SW) DALI (DA) Aqsmart (DB)		

Information about dimensions of optics placement within the luminaire are on page [642](#).



luminaire finishes
 white -13 ○
 black -12 ●
 brutal -85 ●

main material
 aluminium | PMMA

MIXLINE is a linear luminaire that combines **two types of light emission:** diffused and focused. The section with a diffuser provides soft general lighting, while the lens module delivers targeted illumination for work surfaces. Its slim form allows the luminaire to subtly complement the space.

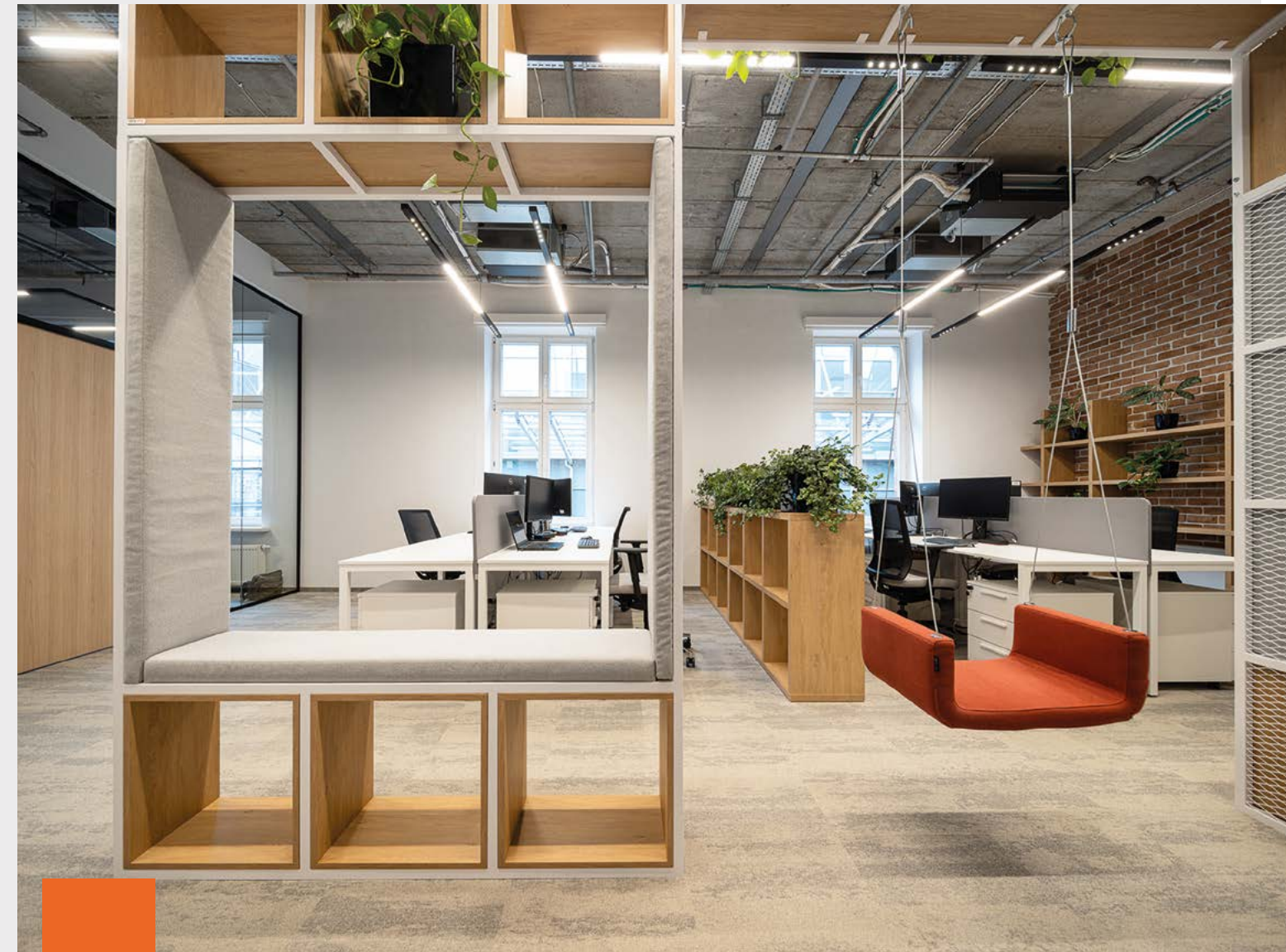

RAFTER

— points section

section

The RAFTER points section is a luminaire that combines a linear form with precise light emission. Deeply recessed light sources minimise glare and deliver highly efficient task lighting over surfaces such as tables, kitchen islands or desks.

recessed p. 104-114
 surface p. 206-212
suspended
 track p. 430-438
 wall p. 494
 systems p. 618

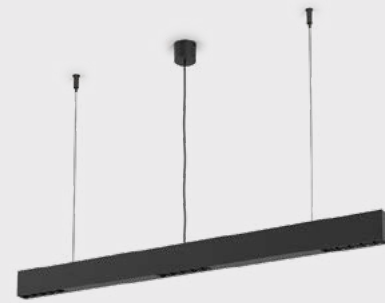

RAFTER points section LED

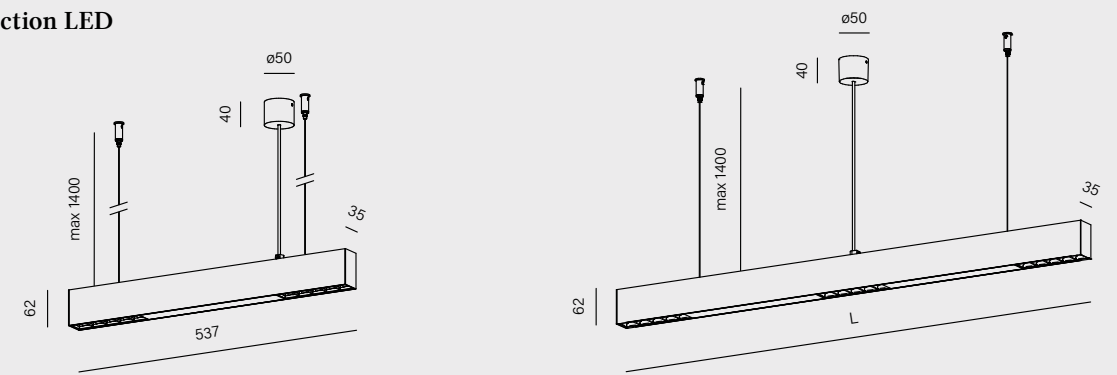

length	cat. n°	length	cat. n°
537mm	50593-M930-WB-00-12	936mm	50594-M930-WB-00-12
		1335mm	50595-M930-WB-00-12
		1734mm	50596-M930-WB-00-12
power:		7.5W - 18W (L) 14.5W - 37W (M)	
flux:		843lm - 4395lm	
optics:		37° (F) 50° (W)	
CCT:		2700K (27) 3000K (30) 4000K (40)	
control:		ON/OFF (00) DALI (DA) AQsmart (DB) ON/OFF (00) switchDIM (SW) DALI (DA) AQsmart (DB)	

UGR ≤ 19 | 230V | ≥ 90 CRI | ≤ 0.4 beam spread | IP20

Information about dimensions of optics placement within the luminaire are on page 642.



- optics finishes**
- white -_W ○
 - black -_B ●
- luminaire finishes**
- white -13 ○
 - black -12 ●
 - brutal -85 ●

main material
 aluminium | PC

RAFTER_

RAFTER is a linear luminaire with a slim profile and versatile character. The version with an opal diffuser emits soft, evenly distributed light and works well as general lighting. It combines functionality with a sense of visual order in the interior.

Biurowca Centrum Badawcze - Rozwojowe Celon-Pharma 3500 m², Warszawa / Kazimierz Nowy

recessed p. 104-114
surface p. 206-212
suspended
Track p. 430-438
wall p. 494
systems p. 618



RAFTER LED

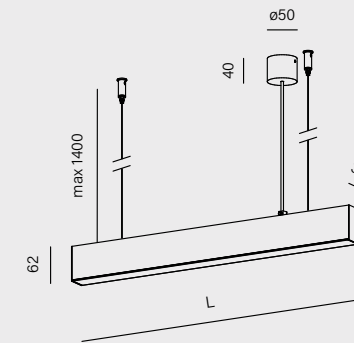

length	cat. n°
570mm	50600-M930-D9-00-12
860mm	50601-M930-D9-00-12
1140mm	50602-M930-D9-00-12
1420mm	50603-M930-D9-00-12
1700mm	50604-M930-D9-00-12
1980mm	50605-M930-D9-00-12
power:	8.5W - 30W (L) 17W - 60W (M) 25W - 87W (H)
flux:	1164lm - 10864lm
CCT:	2700K (27) 3000K (30) 4000K (40)
control:	ON/OFF (00) switchDIM (SW) DALI (DA) Aqsmart (DB)



luminaire finishes

- white -13 ○
- black -12 ●
- brutal -85 ●

main material

aluminium | PMMA



OPTIMA

OPTIMA is a luminaire designed with ergonomics and work requirements in mind. Available in versions with downward or up & down light emission, it evenly illuminates the desk surface and its surroundings, supporting optimal conditions for everyday tasks.

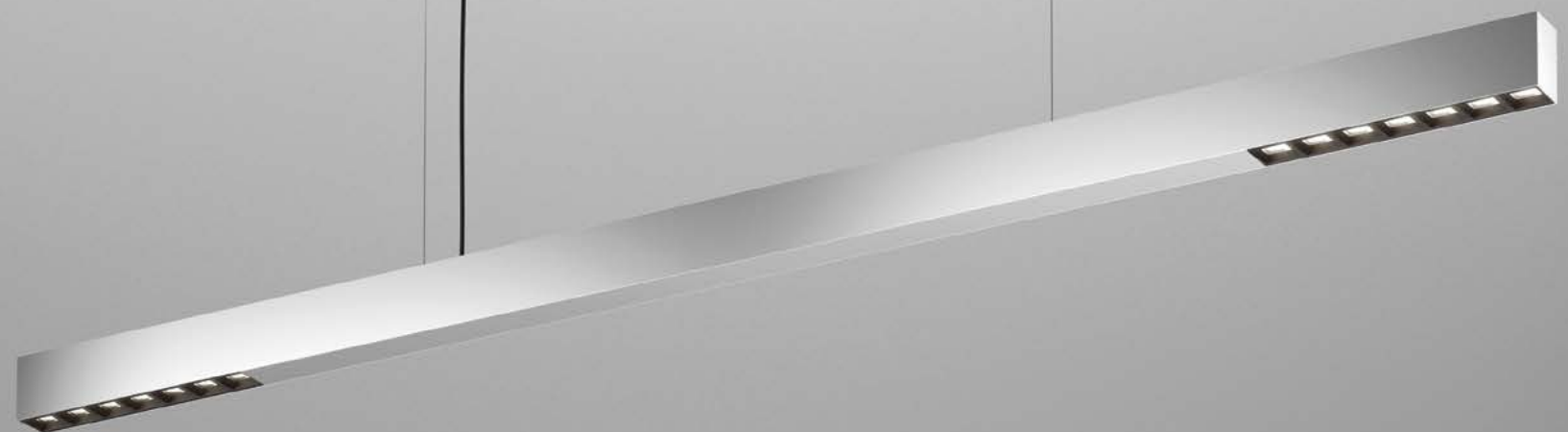
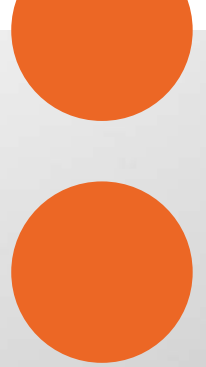

OPTIMA up&down LED

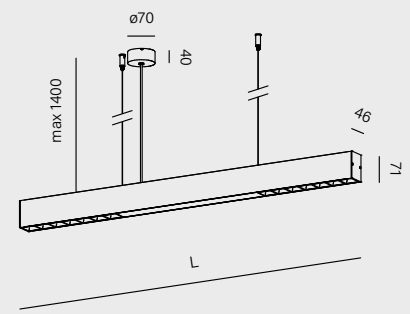

length	cat. n°
980mm	59883-M930-WB-00-12
1380mm	59884-M930-WB-00-12
1680mm	59885-M930-WB-00-12
power:	51W (M)
flux:	6757lm
optics:	73° (W)
CCT:	3000K (30) 4000K (40)
control:	ON/OFF (00) switchDIM (SW) DALI (DA) Aqsmart (DB)



Information about dimensions of optics placement within the luminaire are on page [642](#).

optics detail

black -_B- white -_W-



optics finishes

- white -_W- ○
- black -_B- ●

luminaire finishes

- white -13 ○
- black -12 ●
- brutal -85 ●

main material

aluminium | PC

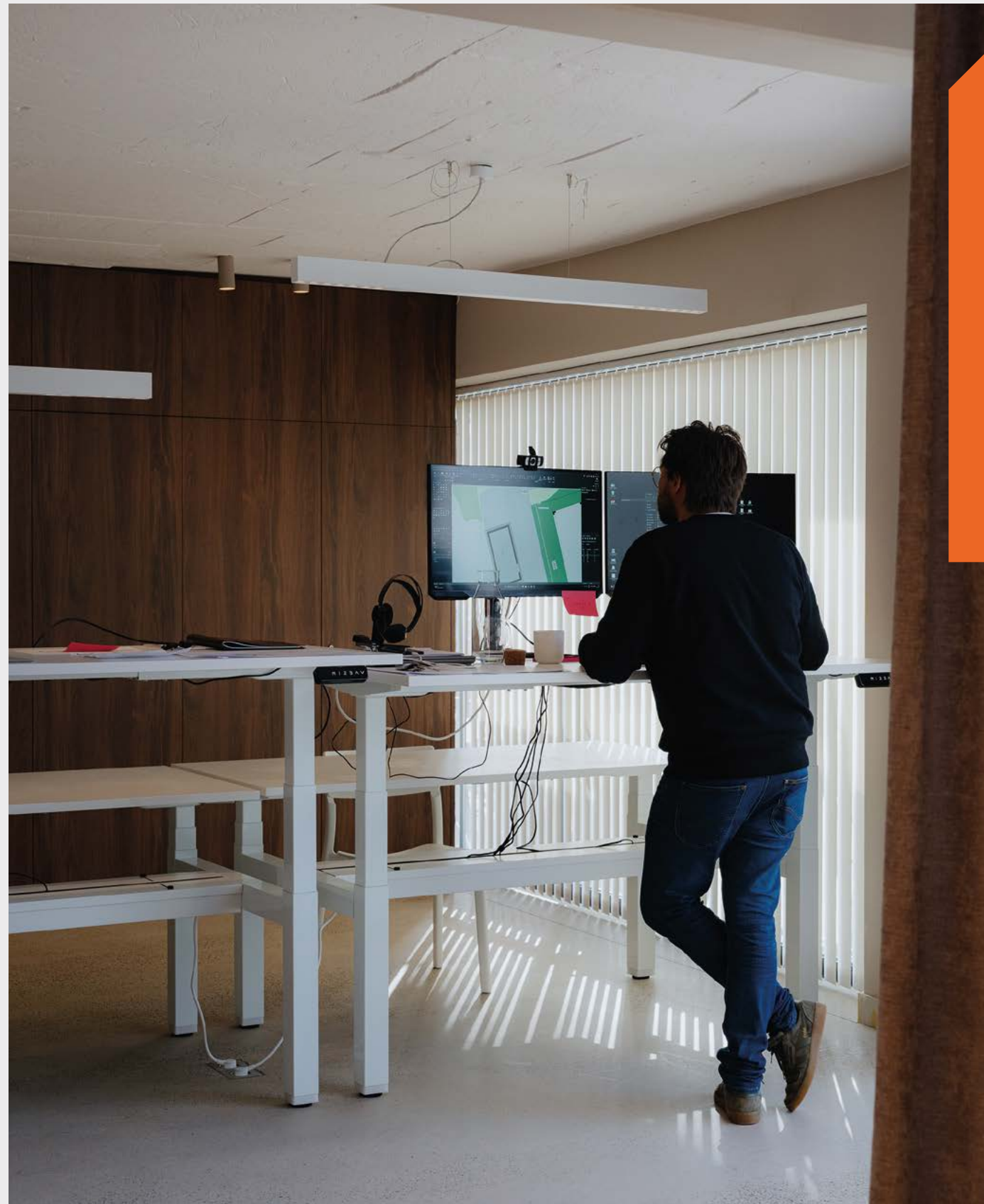

The primary role of office lighting is to balance efficiency with user satisfaction. OPTIMA delivers both through a carefully refined light distribution. The downward beam illuminates the work surface precisely, while the up & down version also brightens the surroundings through light reflected from the ceiling. As a result, one luminaire can provide both task and general illumination.

In many office layouts, with the right luminaire length and a bright ceiling, OPTIMA can successfully replace multiple light points without the need for additional planning. A single luminaire is also capable of evenly illuminating two desks positioned back to back, offering an efficient and economical solution for contemporary workplaces.

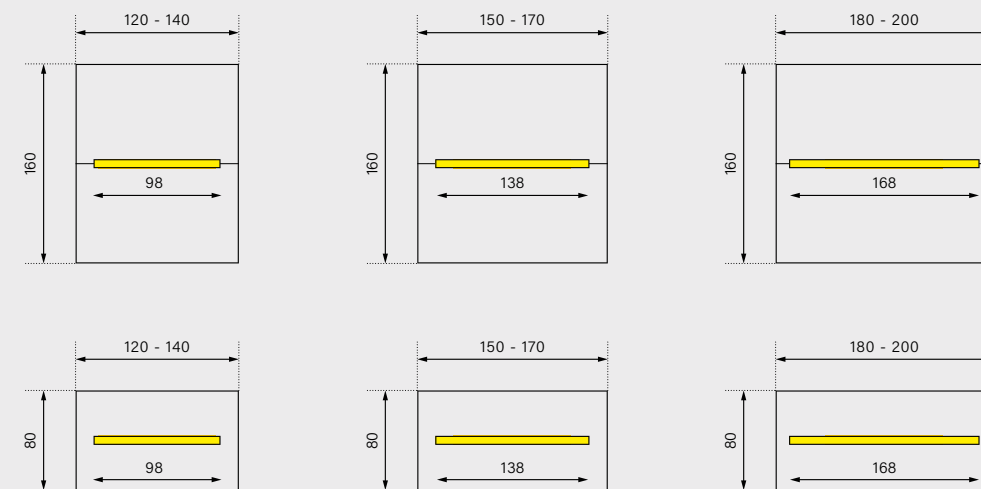
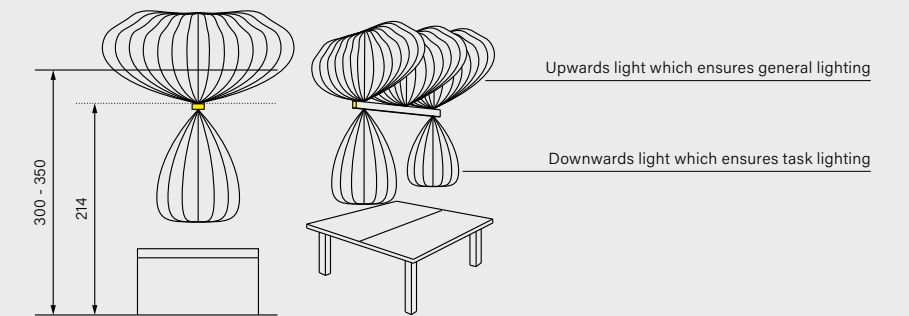



SET TRU LED suspended

Office, Zielona Góra

SET TRU

Elegant lines and balanced proportions make SET TRU well suited for workspaces. Versions with a microprismatic diffuser provide even lighting for desks and tables, supporting concentration during everyday use. Versions with an opal diffuser work well as general lighting in larger spaces.

recessed p. 122
surface p. 224
suspended
Track p. 442
wall p. 496
systems p. 614

SET TRU

FUNCTIONAL AND MODERN

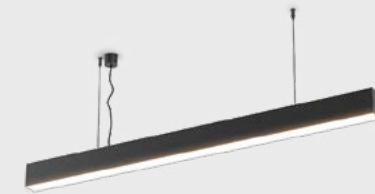

SET TRU LED

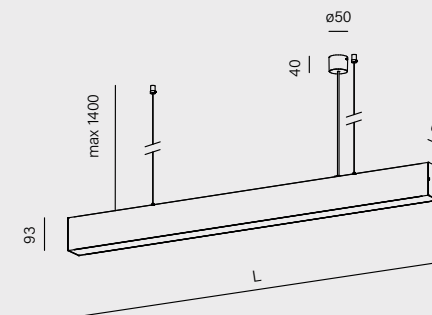

length	cat. n°
570mm	54549-M930-D9-00-12
860mm	54551-M930-D9-00-12
1140mm	54553-M930-D9-00-12
1420mm	54555-M930-D9-00-12
1700mm	54557-M930-D9-00-12
1980mm	54559-M930-D9-00-12
power:	8.5W - 30W (L) 17W - 60W (M)
flux:	1164lm - 8148lm
optics:	opal (D9) microprism (D5)
CCT:	2700-6500K (62) ¹ 2700K (27) 3000K (30) 4000K (40)
control:	ON/OFF (00) switchDIM (SW) DALI (DA) Aqsmart (DB)



¹ the opal version (D9) has a Tunable-White option available from length 1140mm | ² only for microprism (D5)

covers comparison



luminaire finishes

- white -13 ○
- black -12 ●
- brutal -85 ●

main material

aluminium | PMMA | steel



Design: Golaska Studio | Photo: Krzysztof Strażyński STUDIO



INTERIOR **TRACK**

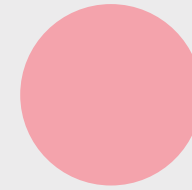
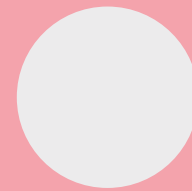
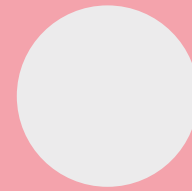
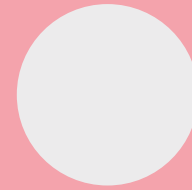

PRECISION
AND FLEXIBILITY

INTERIOR TRACK

MULTITRACK

QRLED next multitrack



[p. 408](#)

QRLED next suspended multitrack



[p. 408](#)

QRLED next high multitrack



[p. 408](#)

TRIBA mini multitrack



[p. 414](#)

TRIBA mini suspended multitrack



[p. 414](#)

TRIBA mini high multitrack



[p. 414](#)

PET mini multitrack



[p. 416](#)

PET mini suspended multitrack



[p. 416](#)

PET mini high multitrack



[p. 416](#)

PET midi multitrack



[p. 420](#)

PET midi high multitrack



[p. 420](#)

HYPER zoom multitrack



[p. 426](#)

HYPER zoom high multitrack



[p. 426](#)

ALULINE mini multitrack



new

[p. 428](#)

ALULINE mini points multitrack



new

[p. 428](#)

RAFTER mini multitrack



[p. 430](#)

RAFTER mini move multitrack



[p. 430](#)

RAFTER mini move high multitrack



[p. 430](#)

RAFTER mini points multitrack



[p. 432](#)

RAFTER mini points move multitrack



[p. 432](#)

RAFTER mini points move high multitrack



[p. 432](#)

RAFTER multitrack



[p. 436](#)

RAFTER high multitrack



[p. 436](#)

RAFTER points multitrack



[p. 438](#)

RAFTER points high multitrack



[p. 438](#)

TUBE stiff multitrack



[p. 444](#)

TUBE flex multitrack



[p. 444](#)

TUBE flex high multitrack



[p. 444](#)

MODERN BALL simple midi multitrack







[p. 448](#)





MODERN BALL simple midi suspended multitrack



[p. 448](#)

<p>TRIBA mini microtrack</p>  <p>new</p> <p>p. 414</p>	<p>TRIBA mini suspended microtrack</p>  <p>new</p> <p>p. 414</p>	<p>PET mini microtrack</p>  <p>p. 416</p>	<p>PET mini suspended microtrack</p>  <p>p. 416</p>	<p>PET midi microtrack</p>  <p>new</p> <p>p. 420</p>
---	---	---	--	---

<p>HYPER zoom track</p>  <p>p. 426</p>	<p>RAFTER track</p>  <p>p. 436</p>	<p>RAFTER points track</p>  <p>p. 438</p>	<p>BLOS round track</p>  <p>p. 446</p>	<p>BLOS round suspended track</p>  <p>p. 446</p>
--	--	---	--	--

<p>RAFTER mini move microtrack</p>  <p>new</p> <p>p. 430</p>	<p>RAFTER mini points microtrack</p>  <p>p. 432</p>	<p>RAFTER mini points move microtrack</p>  <p>p. 432</p>	<p>RAFTER points microtrack</p>  <p>p. 438</p>	<p>MODERN BALL simple mini microtrack</p>  <p>p. 448</p>
---	---	--	---	--

<p>MODERN BALL simple midi track</p>  <p>p. 448</p>	<p>MODERN BALL simple midi suspended track</p>  <p>p. 448</p>
---	---

<p>MODERN BALL simple mini suspended microtrack</p>  <p>p. 448</p>	<p>3F TRACK QRLED next track</p>  <p>p. 408</p>	<p>TRIBA midi track</p>  <p>p. 412</p>	<p>TRIBA midi GU10 track</p>  <p>new</p> <p>p. 412</p>	<p>TRIBA midi GU10 suspended track</p>  <p>new</p> <p>p. 412</p>
--	---	--	--	---

<p>TRIBA midi E27 suspended track</p>  <p>p. 412</p>	<p>PET mini track</p>  <p>p. 416</p>	<p>PET midi track</p>  <p>p. 420</p>	<p>PET maxi track</p>  <p>p. 420</p>	<p>PET GU10 track</p>  <p>p. 420</p>
--	--	--	---	--

INTERIOR TRACK

Track systems organize light and open the door to change. A single installation enables the creation of various scenes, the repositioning and replacement of luminaires, and the shaping of light direction, all while maintaining a clear layout and cohesive aesthetics.

PET midi LED track

Your Art Maison Art Gallery, Warszawa

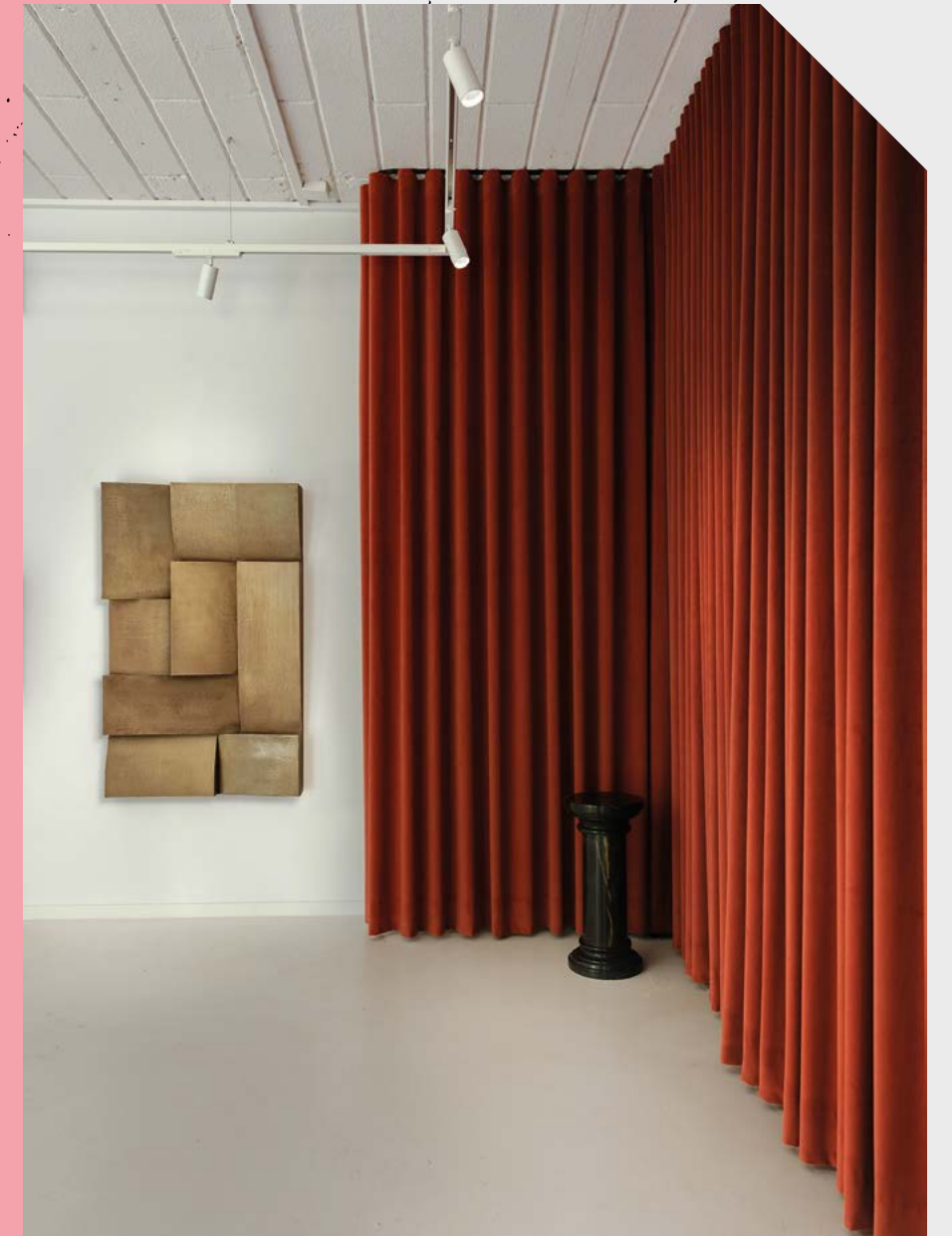

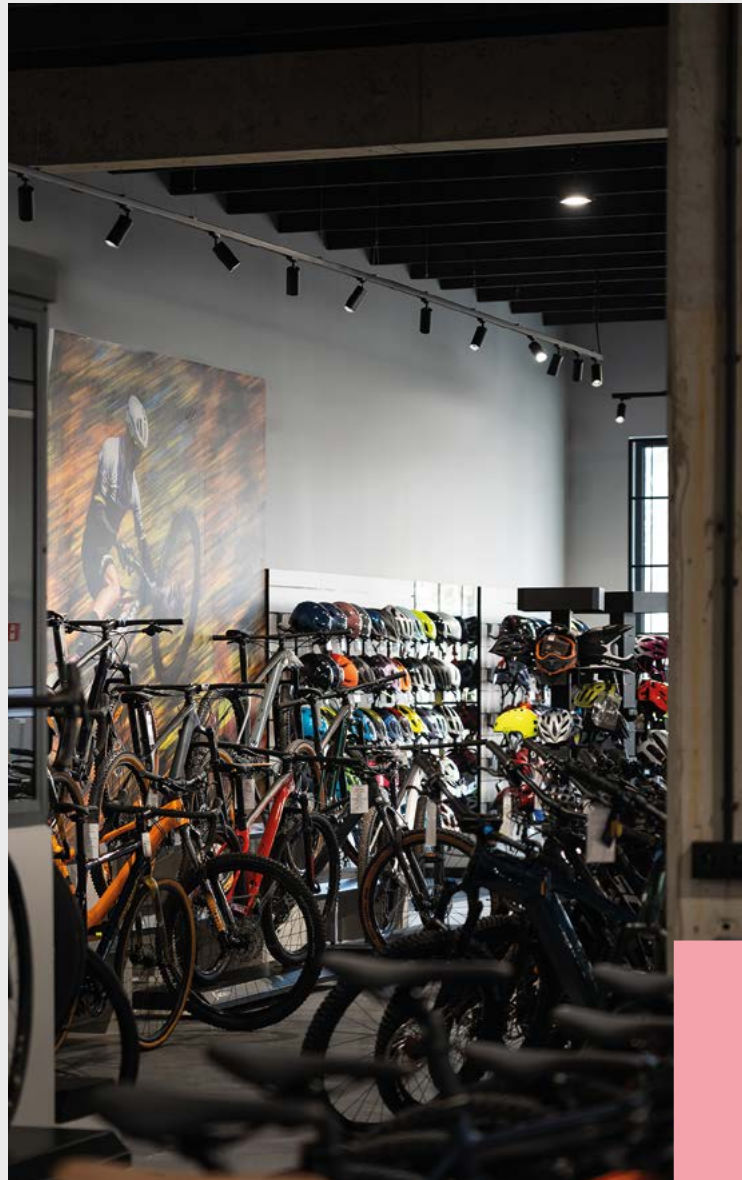

This solution promotes harmony and order:

Within a single system, you can combine spotlights, pendant forms, or linear fixtures, adjusting their spacing and quantity to suit the function of the space.

When the arrangement changes, the composition follows – quickly and effortlessly.

The same system also allows for gradual expansion without compromising visual consistency.



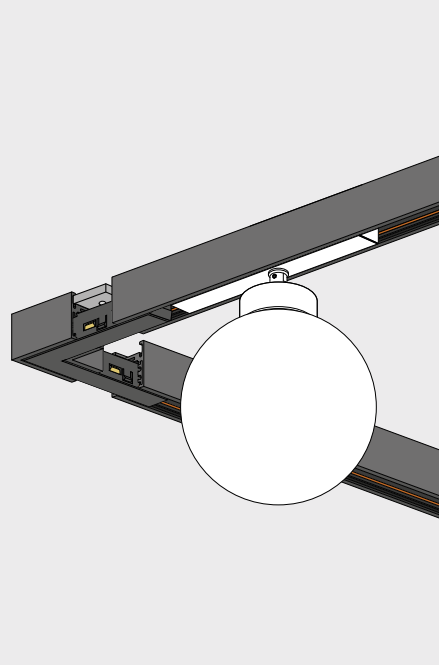

MULTITRACK
surface/suspended | recessed

A system based on small-sized lighting tracks with a very simple form. Available accessories and connectors allow for creating elaborate configurations, including transitions from the ceiling to the wall. A safe 48V voltage is used inside the track rail, making the MULTITRACK system suitable for locations within arm's reach. A separate power supply is required.

The system offers multiple control options, including two independent circuits using two power supplies, as well as Casambi or DALI control.

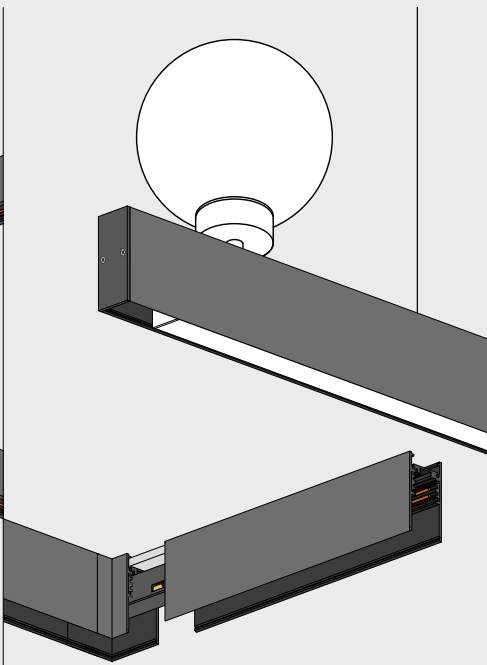

HIGH MULTITRACK
surface/suspended | up&down suspended

High, surface-mounted versions allow for elegant flush mounting of luminaires within the track and almost perfect concealment of connectors and spotlight adapters. With the new HIGH MULTITRACK up&down, it is also possible to achieve upward lighting, either to illuminate a specific object or to create general lighting using uplight. Especially recommended for very tall interiors with beautiful ceilings.

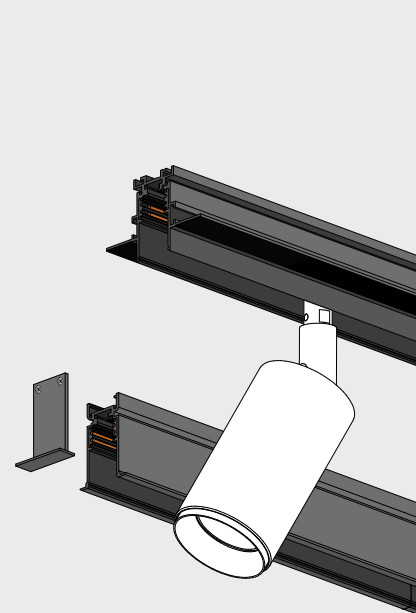

HIGH MULTITRACK
recessed | trim recessed

A higher version of the MULTITRACK system, retaining all its advantages. It utilizes the same electrical accessories and allows for transitions from the ceiling to the wall. Due to its increased depth, linear luminaires fit seamlessly within the track. The adapters and electrical connectors become nearly invisible. This creates an elegant, uniform line. Like any low-voltage system, HIGH MULTITRACK requires an appropriate power supply and electrical connection.

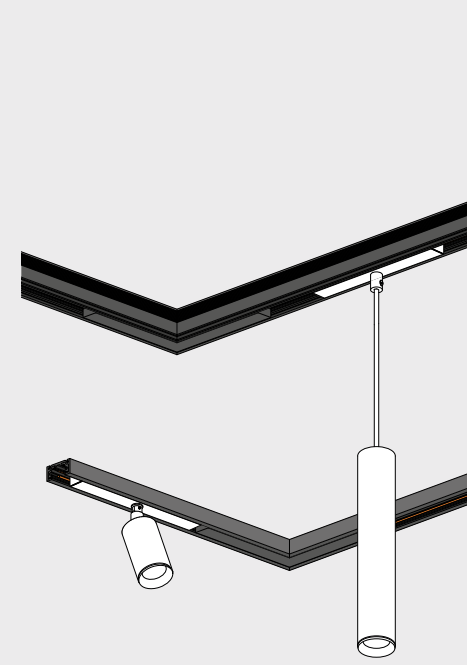

MICROTRACK
surface | recessed

A delicately designed track system with compact dimensions. The recessed version creates a narrow slit in the finished suspended ceiling, measuring just 11mm in width.

The surface-mounted model is less than 2cm wide and 1cm high. It allows for transitions from the wall to the ceiling.

This is a low-voltage system operating at 48V, which requires the use of a power supply.

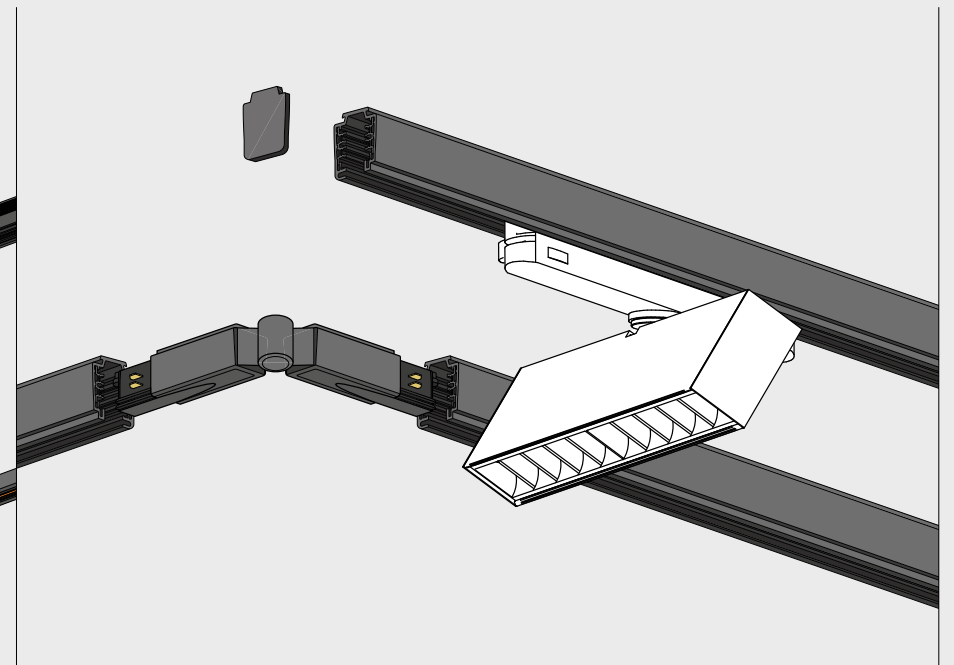

3F and 3F DALI
surface/suspended | recessed

The most popular system powered by 230V. Connection requires only a standard cable on the ceiling and a power end cap or one of the connectors with the possibility of power connection (straight connector, "L", "T" or "X"). 3F tracks allow the luminaires to be divided into three independent circuits. This requires running a 5-wire cable between the switches on the wall and connecting the track.

There is also a DALI 3F version available for indoor use with a wired digital control system based on the DALI protocol.

Tracks – a way to achieve well-adapted lighting

Lighting tracks are very flexible solutions. Their main advantages include powering many luminaires from one point and the ability to easily change the arrangement and number of luminaires. They perform well in shops, galleries and restaurants, as well as in residential spaces.

MULTITRACK models are distinguished by their simple form and safe voltage of 48V inside the track. They can be mounted not only on the ceiling, but also on the wall, within arm's reach.

MULTITRACK is a surface-mounted version with a shorter track height. It can also be used as a suspended solution. MULTITRACK comes also as a recessed variant. In both cases, the frame adapters are flush with the track edge. Higher versions – surface-mounted and recessed – are solutions in which the linear fixtures are completely hidden in the track.

3F tracks are very popular systems. They are available in a surface-mounted version (which, when supplemented with cable slings, will serve as a suspended version), as well as a recessed version available on request. 3F tracks are also available in the DALI version.

HIGH MULTITRACK surface/suspended | recessed | recessed trim | suspended up&down

48V | max 3 metres in one piece | ON-OFF (one or two circuits) | DALI can be safely installed on walls | requires 48V power supply

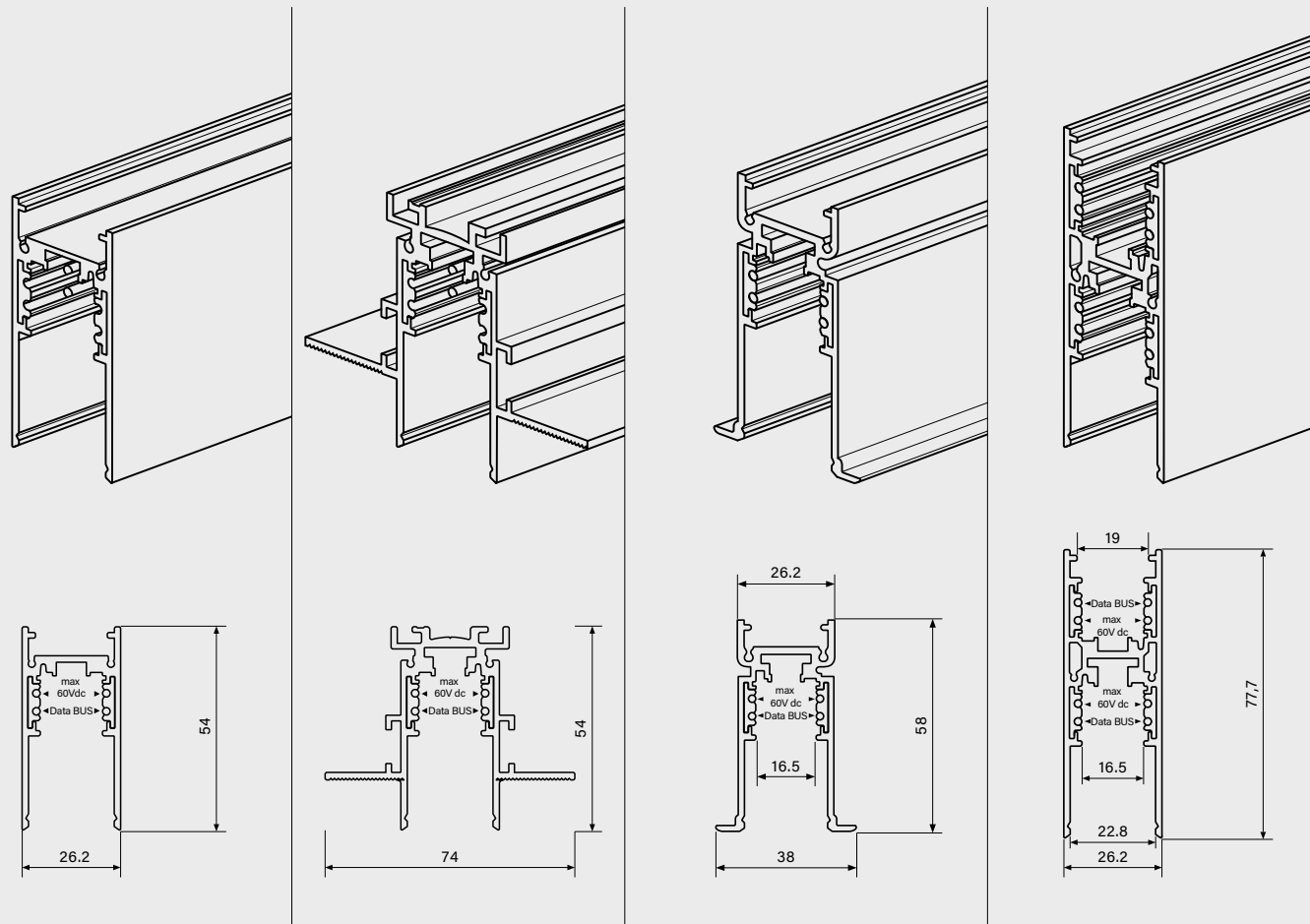

MULTITRACK surface/suspended | recessed

48V | max 3 metres in one piece | ON-OFF (one or two circuits) DALI | can be safely installed on walls | requires 48V power supply

¹ length 3 meters is available only for selected tracks variants

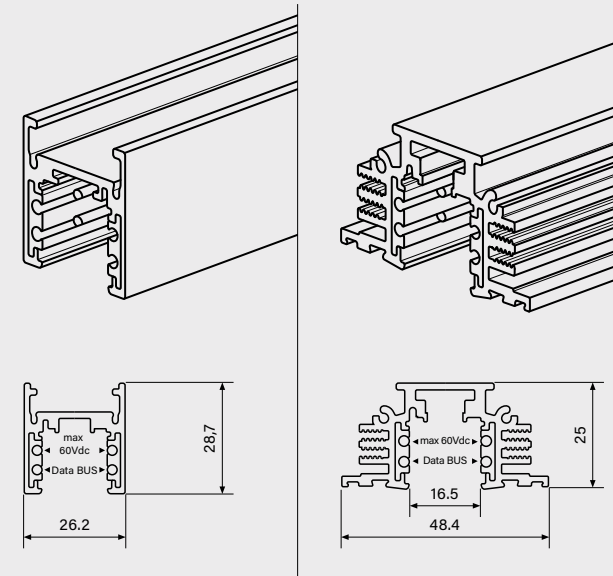

MICROTRACK surface | recessed

48V | max 2 metres in one piece | ON-OFF | DALI Extremely thin | can be safely installed on walls

Requires 48V power supply

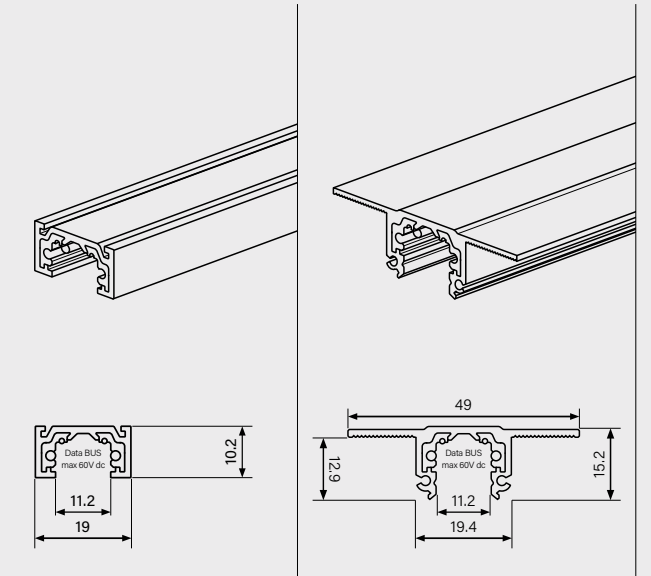

TRACK 3F surface/suspended | 3F recessed | DALI surface/suspended | DALI recessed

230V | max 3 metres for surface/suspended and 2 metres for recessed in one piece | ON-OFF (three circuits) | DALI

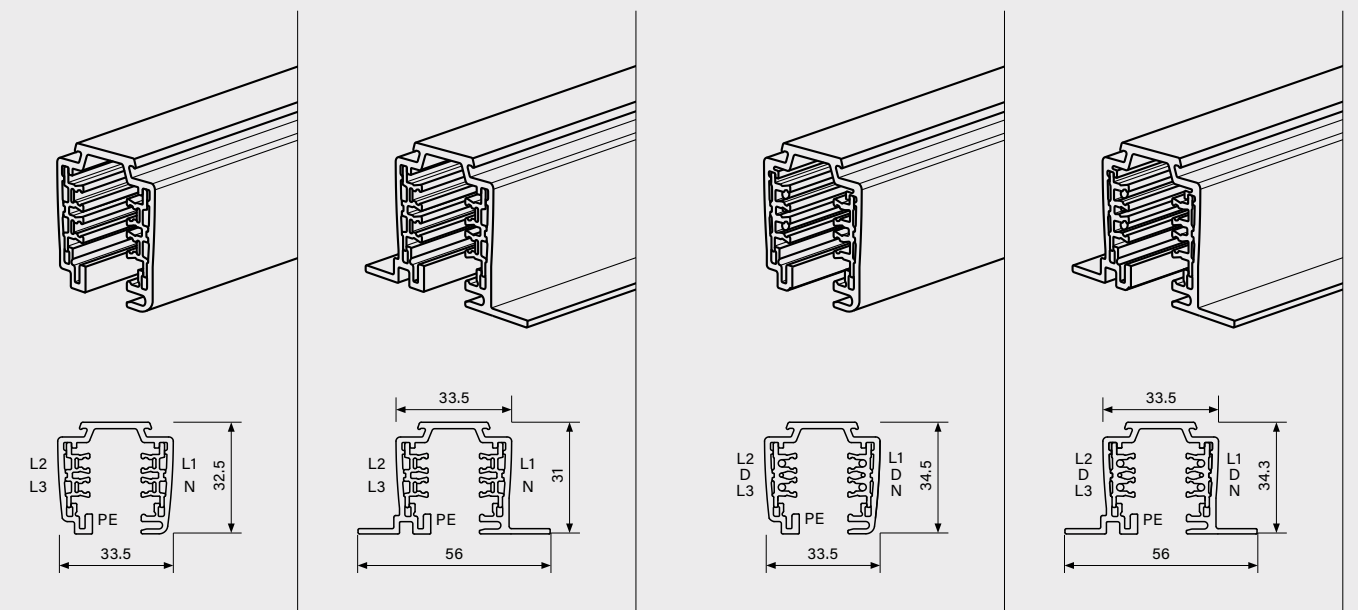

**MULTITRACK
recessed**



In MULTITRACK system the adapter flush with the track edges. Recessed version does not require any special construction of the ceiling and can be installed in already existing but not yet finished soffit.

MULTITRACK surface and MULTITRACK recessed are available in QS range.

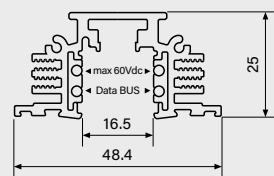

**HIGH MULTITRACK
recessed**



In HIGH MULTITRACK system the adapter recess completely inside the track. For this reason, tiltable parts of the luminaires require a longer joint, allowing them to be easily adjusted once installed. Proper installation of this system requires construction of the suspended ceiling to be prepared before installation of the track.

HIGH MULTITRACK recessed system is available in the QS range.

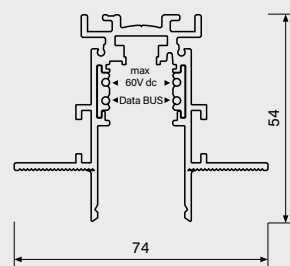

**HIGH MULTITRACK trim
recessed**



An ideal solution wherever a subtle MULTITRACK form and maximally practical installation are required. The narrow frame simplifies and shortens installation while maintaining the minimalist and cohesive effect characteristic of this product family.

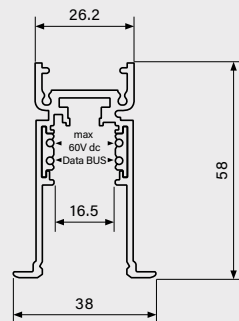

**HIGH MULTITRACK UP&DOWN
suspended**



A boutique in a tenement house with beautiful stucco, a two-story living room, or even an office or study – in each of these interiors, it may be worth illuminating the ceiling for various reasons. HIGH MULTITRACK up&down allows for the installation of lighting fixtures both in the lower, deep section and in the upper, lower part.

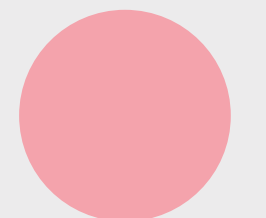
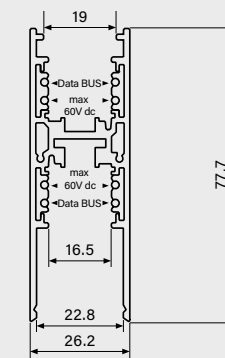



Maximum load

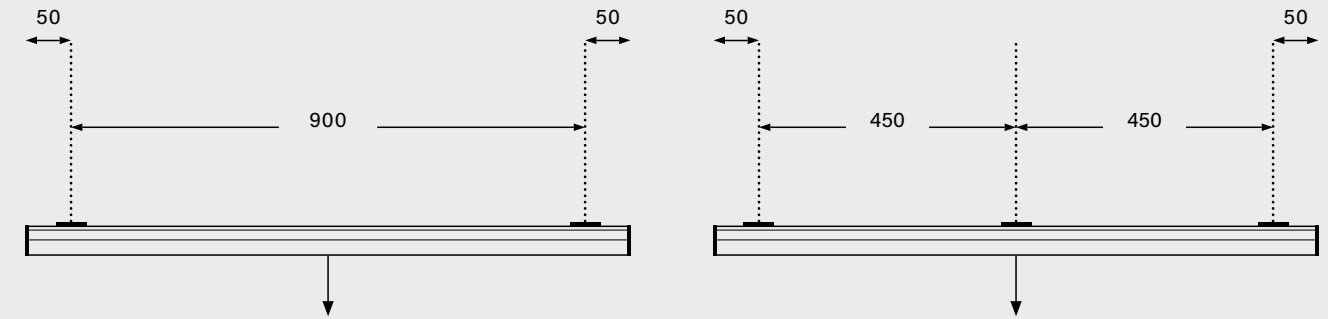

MULTITRACK

recessed - **24 kg** | surface / suspended - **25 kg**

recessed - **44 kg** | surface / suspended - **36 kg**

HIGH MULTITRACK

recessed / surface / suspended - **24 kg**

recessed / surface / suspended - **44 kg**

MICROTRACK

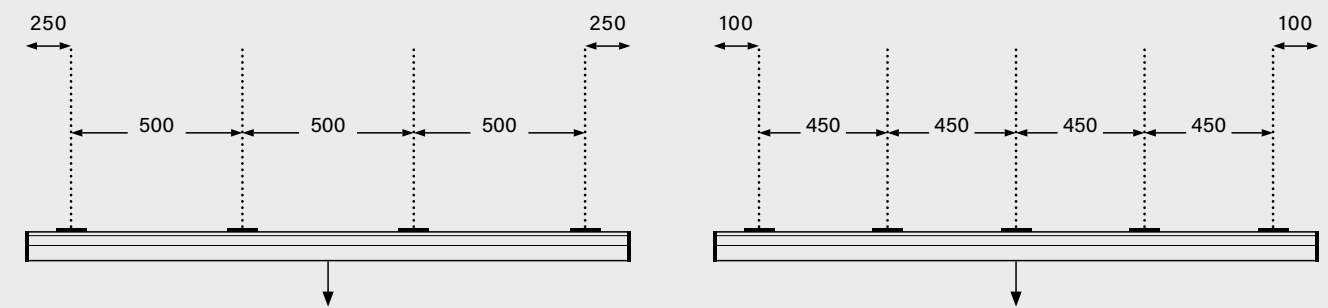

recessed - **15 kg**

surface - **15 kg**

3F TRACK

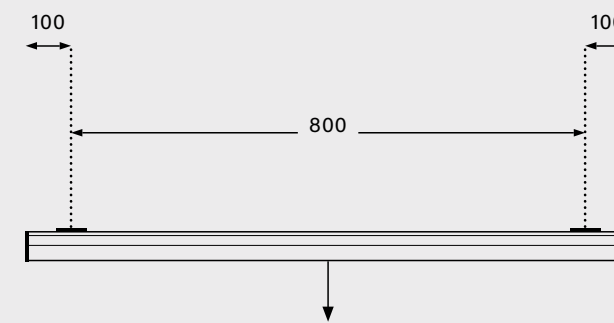

recessed / surface / suspended - **30 kg**

EASY TO COMPLETE

MULTITRACK / HIGH MULTITRACK

1. Choose your track and preferred installation method

Configuring AQForm track systems involves just a few simple steps. First, you choose the system (MULTITRACK, HIGH MULTITRACK, MICROTRACK, or 3F track) and the mounting method: recessed, surface-mounted or suspended.

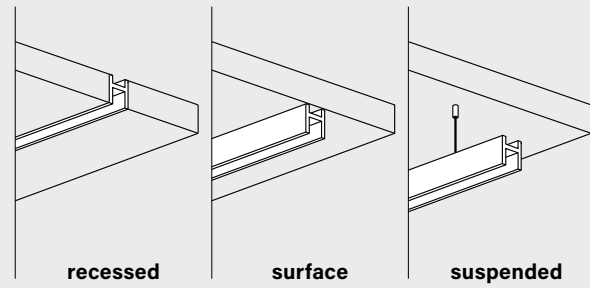

2. Select connectors to create your custom layout

Next, you plan the layout: straight sections, corners, connectors, as well as the 48V power connection point.

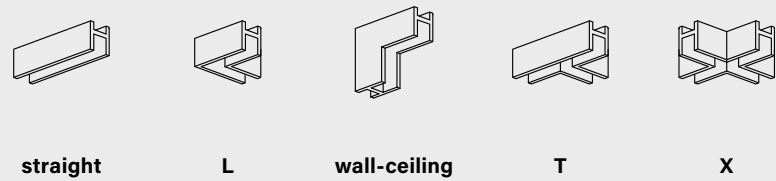

3. Choose the appropriate power supply

The following step is selecting the accessories required for the chosen system. For 48V systems, the power supply and its placement are also selected.

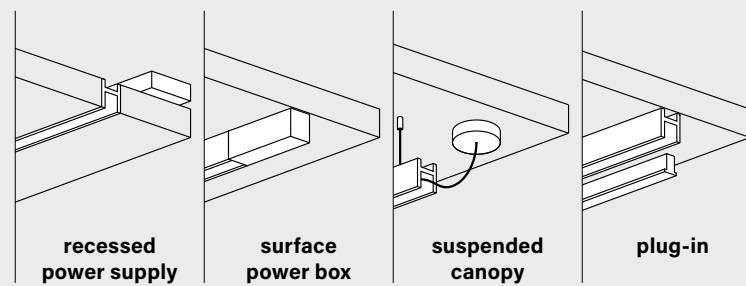

4. Install the dedicated fixture

Finally, you complete the setup with luminaires compatible with the selected track. You verify the permissible load, suspension spacing, and section lengths. This structured decision-making process makes future modifications and system expansion much easier.

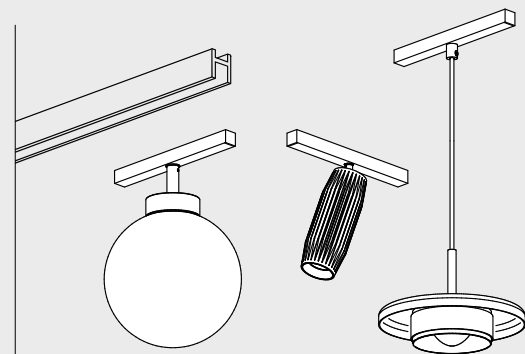

MICROTRACK



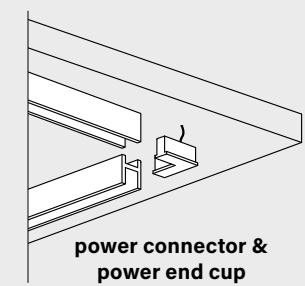
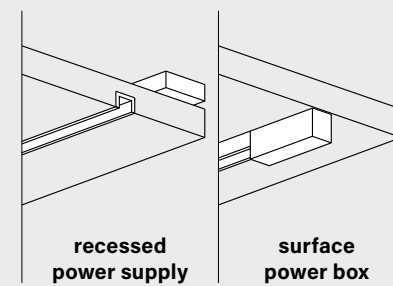
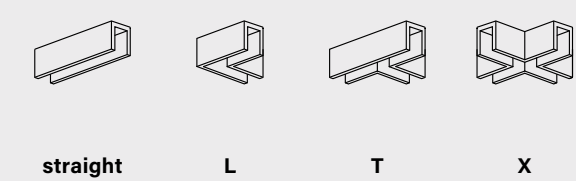
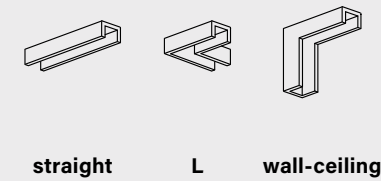
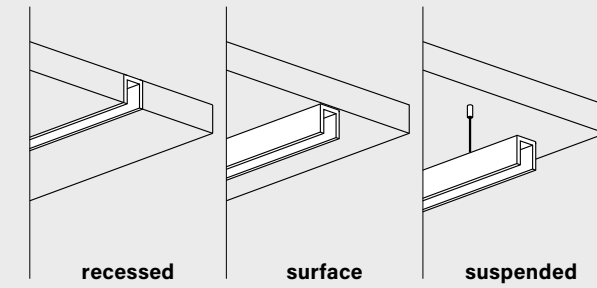
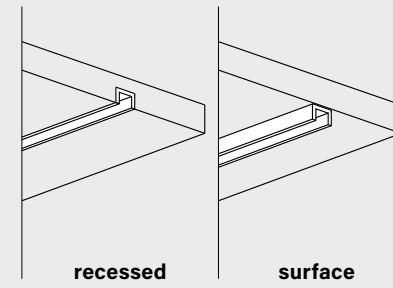

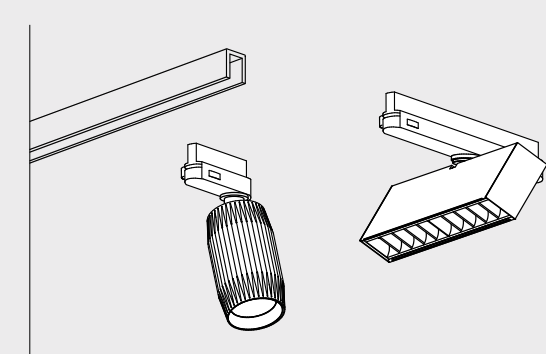
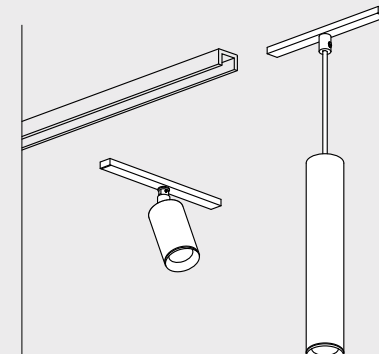

3F TRACK

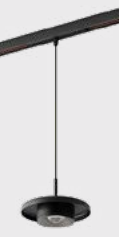

does not require a power supply



Luminaires compatible with the system UP&DOWN

	UP	DOWN
	RAFTER HIGH MULTITRACK version	HIGH MULTITRACK version
	QRLED next suspended not recommended	MULTITRACK version
	QRLED next HIGH MULTITRACK version	HIGH MULTITRACK version
	PET mini suspended not recommended	MULTITRACK version
	PET mini / PET midi HIGH MULTITRACK version	HIGH MULTITRACK version
	MODERN BALL simple suspended not recommended	MULTITRACK version
	MODERN BALL simple MULTITRACK version	HIGH MULTITRACK version
	HYPER HIGH MULTITRACK version	HIGH MULTITRACK version

	TUBE flex not recommended	HIGH MULTITRACK version
	TUBE stiff MULTITRACK version	incompatible
	ALLUINE mini points MULTITRACK version	MULTITRACK version
	ALLUINE mini MULTITRACK version	MULTITRACK version
	TRU mini incompatible	MULTITRACK version
	TRIBA mini suspended not recommended	MULTITRACK version
	TRIBA mini HIGH MULTITRACK version	HIGH MULTITRACK version
	RAFTER mini move HIGH MULTITRACK version	HIGH MULTITRACK version
	RAFTER mini move points HIGH MULTITRACK version	HIGH MULTITRACK version
	RAFTER mini points incompatible	MULTITRACK version
	RAFTER points HIGH MULTITRACK version	HIGH MULTITRACK version

NEW COLOURS

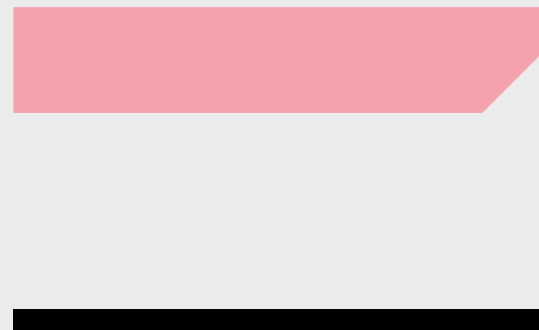

MULTITRACK and HIGH MULTITRACK in surface-mounted and suspended versions are now also available in taupe and terracotta finishes. The new colours make it easier to match track systems with interior materials and tones, allowing contrast with the surroundings to be reduced or the installation path to be subtly highlighted, for example above a table or along a corridor. They pair effortlessly with luminaires in the same colours, maintaining a consistent finish throughout. It is a practical update that brings visual clarity and allows for more precise control over how the installation appears within the space.



TERRACOTTA

Both pages: PET midi LED multitrack | RIBBY line up&down LED suspended





TAUPE



MULTITRACK



MULTITRACK is a low-voltage track system available in recessed, surface-mounted, and suspended versions. Its extensive range of connectors and accessories allows for creating complex layouts, including transitions from ceiling to wall.

Thanks to the safe 48V voltage inside the track, the system is also suitable for installation within hand reach. A power supply unit is required and can be discreetly placed, for example within a suspended ceiling or built-in furniture. A wide selection of compatible luminaires in various shapes and applications allows different types of lighting to be combined within a single cohesive system.

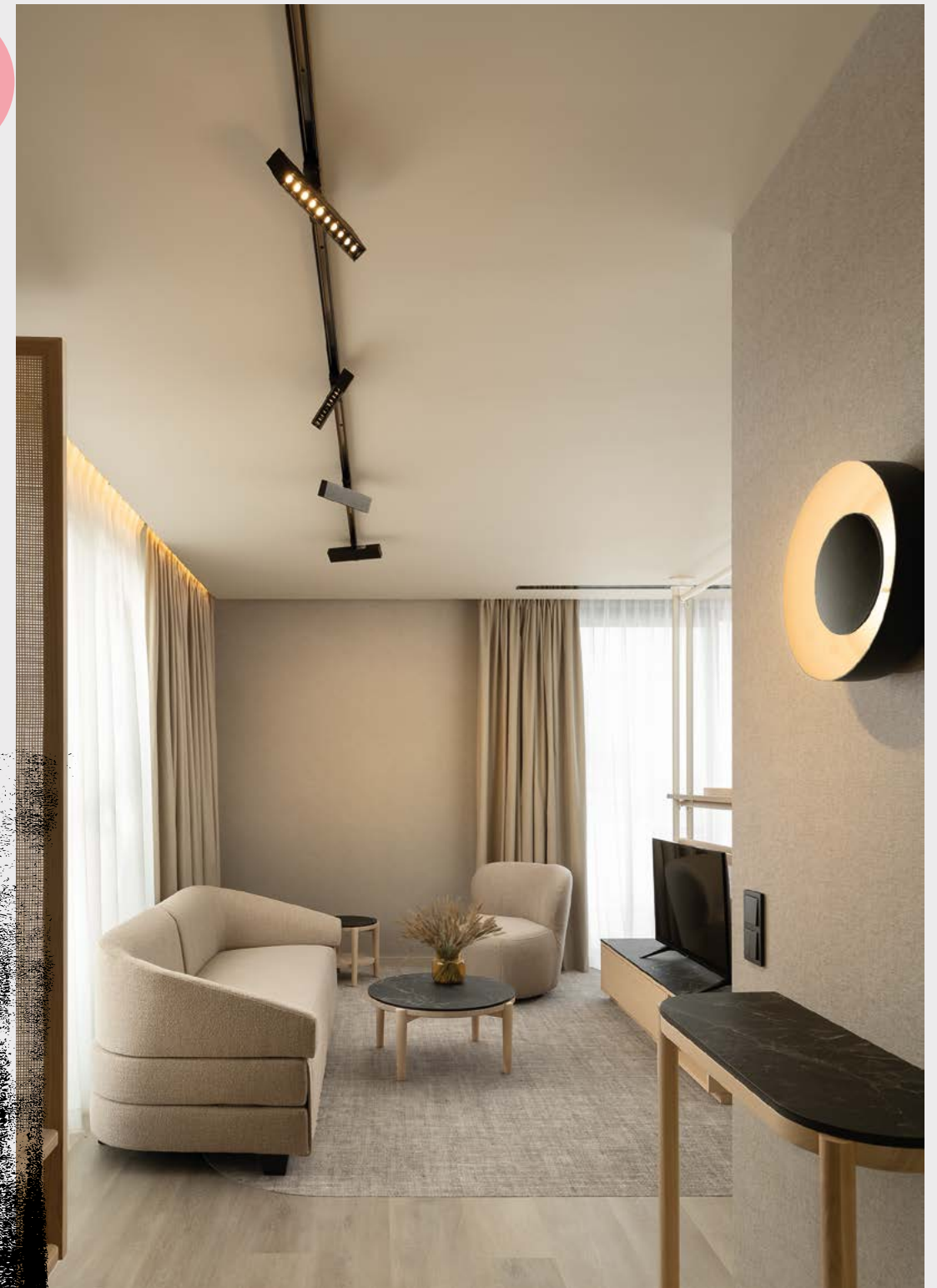
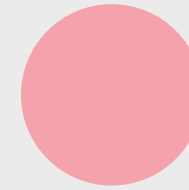
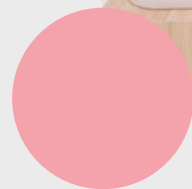



Easy to complete MULTITRACK

The surface/suspended set can be designed in 4 simple steps

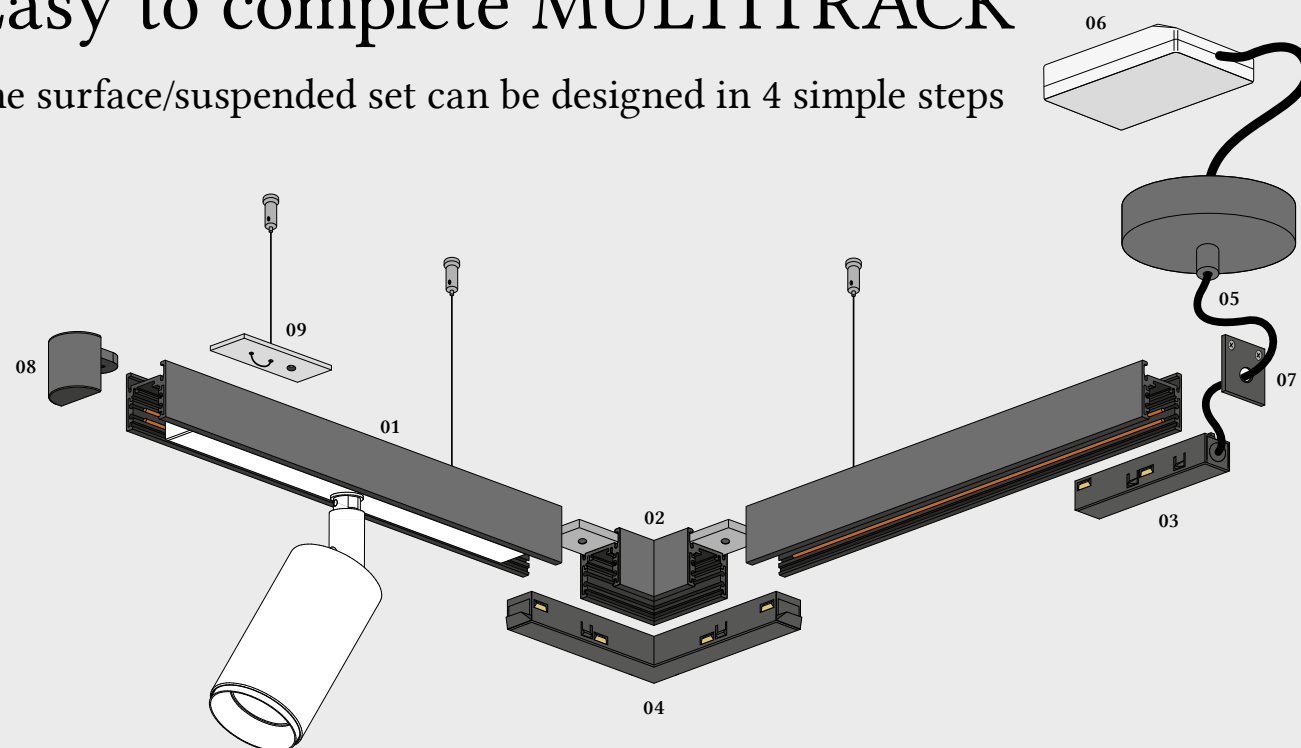

1. Select the track

product	colour	cat. n°	product	colour	cat. n°
MULTITRACK 48V 1m DALI ⁰¹	black	M0010DA12	MULTITRACK 48V surface 1m DALI	black	MC010DA12
	white	M0010DA13		white	MC010DA13
	taupe	M0010DA82		taupe	MC010DA82
	terracotta	M0010DA83		terracotta	MC010DA83
MULTITRACK 48V 2m DALI ⁰¹	black	M0020DA12	MULTITRACK 48V surface 2m DALI	black	MC020DA12
	white	M0020DA13		white	MC020DA13
	taupe	M0020DA82		taupe	MC020DA82
	terracotta	M0020DA83		terracotta	MC020DA83
MULTITRACK 48V 3m DALI ⁰¹	black	M0030DA12	MULTITRACK 48V surface 3m DALI	taupe	MC030DA82
	white	M0030DA13		terracotta	MC030DA83
	taupe	M0030DA82			
	terracotta	M0030DA83			

2. Choose the appropriate connector

product	colour	cat. n°	product	colour	cat. n°
MULTITRACK 48V mounting plate				aluminium	M00MP001
MULTITRACK 48V surface mechanical straight connector universal				aluminium	MSMUN001
product	colour	cat. n°	product	colour	cat. n°
MULTITRACK 48V mechanical „L” connector universal ⁰²	black	M0VUN0012	MULTITRACK 48V power connector straight universal DALI	black	MPSUNDA12
	white	M0VUN0013		white	MPSUNDA13
	taupe	M0VUN0082		black	MPLUNDA12
	terracotta	M0VUN0083		white	MPLUNDA13
MULTITRACK 48V power connector universal DALI ⁰³	black	MPIUNDA12	MULTITRACK 48V power flexible connector universal DALI	black	MPFUNDA12
	white	MPIUNDA13		white	MPFUNDA12

3. Select the power supply method

3.1. Plug-in driver (drivers mounted within the track):

product	colour	cat. n°	product	colour	cat. n°
MULTITRACK 48V plug-in power supply 100W	black	M00PI1012	MULTITRACK 48V plug-in power supply 250W	black	M00PI2512
	white	M00PI1013		white	M00PI2513

3.2. Driver:

product	colour	cat. n°	product	colour	cat. n°
MULTITRACK 48V surface box 0,1m	black	MCB010012	UNIVERSAL suspended box 1,4m ⁰⁵	black	GSB140012
	white	MCB010013		white	GSB140013
	taupe	MCB010082		taupe	GSB140082
	terracotta	MCB010083		terracotta	GSB140083
MULTITRACK 48V box power supply 100W	black	M0B001012	MULTITRACK 48V power supply 60W ⁰⁶		M00000600
	white	M0B001013	MULTITRACK 48V power supply 100W ⁰⁶		M00001000
	taupe	M0B001082	MULTITRACK 48V power supply 200W ⁰⁶		M00002000
	terracotta	M0B001083	MULTITRACK 48V DIN power supply 120W		M00DI1200

4. Match the remaining components: end caps, mounting elements and other

product	colour	cat. n°	product	colour	cat. n°
MULTITRACK 48V end cup	black	M0C000012	MULTITRACK 48V end cup with hole ⁰⁷	black	M0CHL0012
	white	M0C000013		white	M0CHL0013
	taupe	M0C000082		taupe	M0CHL0082
	terracotta	M0C000083		terracotta	M0CHL0083
MULTITRACK 48V end cup rounded ⁰⁸	black	M0Z000012	MULTITRACK 48V end cup rounded with hole	black	M0ZHL0012
	white	M0Z000013		white	M0ZHL0013
	taupe	M0Z000082		taupe	M0ZHL0082
	terracotta	M0Z000083		terracotta	M0ZHL0083
product	colour	cat. n°	product	colour	cat. n°
MULTITRACK 48V mask cover 3m				black	M0D300012
				white	M0D300013
MULTITRACK 48V suspended suspension set 1,4m ⁰⁹					MSH140000
MULTITRACK 48V wire crimping accessory					MWA000000

Extra

product	colour	cat. n°
MULTITRACK 48V plug-in Aqsmart	black	M00PIAS12
	white	M00PIAS13

Multitrack system can be controlled wirelessly. For wireless control Aqsmart module is needed for each group of luminaires connected to the track. Regardless of Aqsmart module, the luminaire must be in the DALI version. One device can control up to 64 fixtures, which can be divided into a maximum of 8 groups.

Scheme of the MULTITRACK

surface/suspended system

GSB1400__¹
suspended box 1,4m
To complete with power supply M0000__00

M0B0010__¹
box power supply 100W

M0CHL00__¹
end cup with hole

MSH140000
suspended suspension set 1,4m

MPLUNDA__¹
power connector „L”
universal DALI

MSMUN0011
surface mechanical straight
connector universal

M00PI10__¹
plug-in power supply 100W

MPFUNDA__¹
power flexible connector
universal DALI

MPIUNDA__¹
power connector
universal DALI

M0C0000__¹
end cup

M0VUN00__¹
mechanical „L” connector
universal

M00PI25__¹
plug-in power supply 250W

MCB0100__¹
surface box 0,1m

MPFUNDA__¹
power flexible connector
universal DALI

Easy to complete MULTITRACK

The recessed set can be designed in 4 simple steps

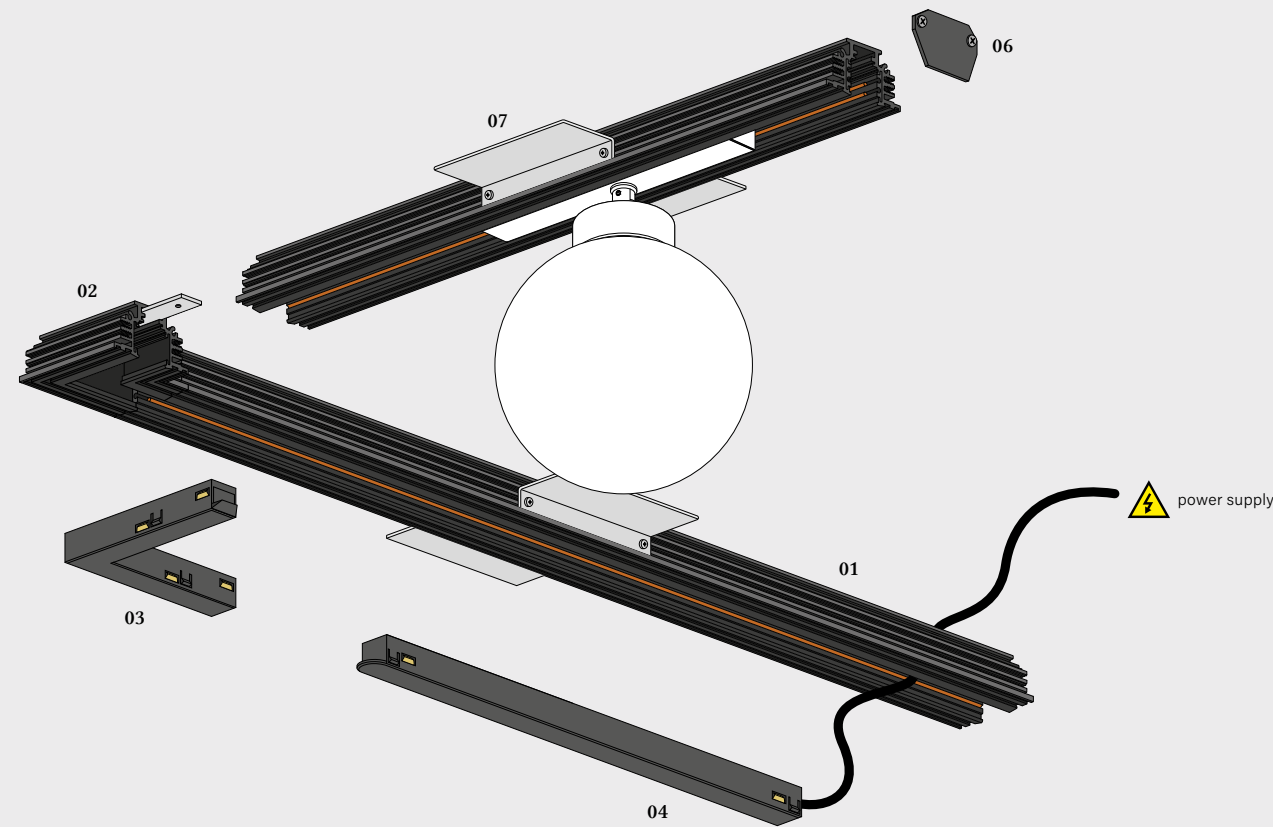

1. Select the track

product	colour	cat. n°	product	colour	cat. n°
MULTITRACK 48V recessed 1m DALI ⁰¹	black	MR010DA12	MULTITRACK 48V recessed 2m DALI ⁰¹	black	MR020DA12
	white	MR010DA13		white	MR020DA13

2. Choose the appropriate connector

product	colour	cat. n°	product	colour	cat. n°
MULTITRACK 48V mechanical straight connector universal				aluminium	M0MUN0011
MULTITRACK 48V recessed mechanical „L” connector ⁰²				black	MRV000012
				white	MRV000013
product	colour	cat. n°	product	colour	cat. n°
MULTITRACK 48V power connector universal DALI	black	MPIUNDA12	MULTITRACK 48V power connector „L” universal DALI ⁰³	black	MPLUNDA12
	white	MPIUNDA13		white	MPLUNDA13
MULTITRACK 48V power connector straight universal DALI	black	MPSUNDA12	MULTITRACK 48V power flexible connector universal DALI	black	MPFUNDA12
	white	MPSUNDA13		white	MPFUNDA13

3. Select the power supply method

3.1. Plug-in driver (drivers mounted within the track):

product	colour	cat. n°	product	colour	cat. n°
MULTITRACK 48V plug-in power supply 100W ⁰⁴	black	M00PI1012	MULTITRACK 48V plug-in power supply 250W	black	M00PI2512
	white	M00PI1013		white	M00PI2513

3.2. Driver:

product	cat. n°
MULTITRACK 48V power supply 60W ⁰⁵	M00000600
MULTITRACK 48V power supply 100W ⁰⁵	M00001000
MULTITRACK 48V power supply 200W ⁰⁵	M00002000
MULTITRACK 48V DIN power supply 120W	M00DI1200

4. Match the remaining components: end caps, mounting elements and other

product	colour	cat. n°
MULTITRACK 48V recessed end cup ⁰⁶	black	MRC000012
	white	MRC000013
MULTITRACK 48V mask cover 3m	black	M0D300012
	white	M0D300013
MULTITRACK 48V recessed mounting foot set ⁰⁷	aluminium	MRE000011
MULTITRACK 48V wire crimping accessory		MWA000000

Extra

product	colour	cat. n°
MULTITRACK 48V plug-in Aqsmart	black	M00PIAS12
	white	M00PIAS13

Multitrack system can be controlled wirelessly. For wireless control Aqsmart module is needed for each group of luminaires connected to the track. Regardless of Aqsmart module, the luminaire must be in the DALI version. One device can control up to 64 fixtures, which can be divided into a maximum of 8 groups.

Scheme of the MULTITRACK

recessed system

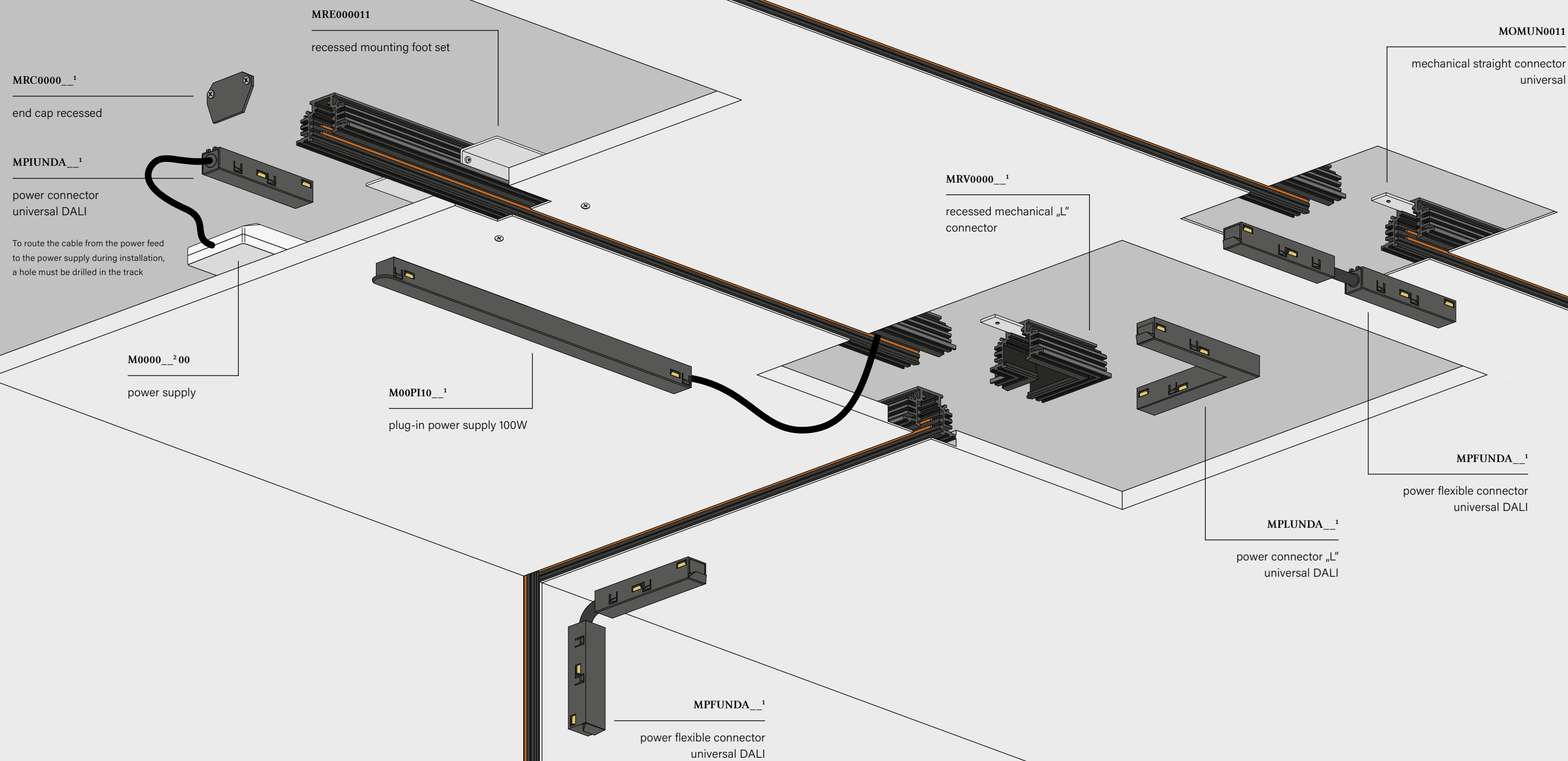

HIGH MULTITRACK

up: ALULINE mini LED multitrack | down: PET midi LED high multitrack | RAFTER mini move LED high multitrack

HIGH MULTITRACK is a low-voltage track system with a taller profile, where luminaire adapters and connectors are hidden inside, and linear luminaires are fully recessed into the track. This ensures a clean, uniform appearance along the entire length of the installation. The system offers recessed, surface-mounted, and suspended installation options, and also supports transitions from ceiling to wall. Visual details are streamlined and future configuration changes are simplified. Dedicated accessories and connectors support the creation of longer sections and precise corners, while the extensive list of luminaires designed for HIGH MULTITRACK allows appropriate fixtures to be selected.



SET TRU mini LED multitrack

Apartment, Poznań





Easy to complete HIGH MULTITRACK

The surface/suspended set can be designed in 4 simple steps

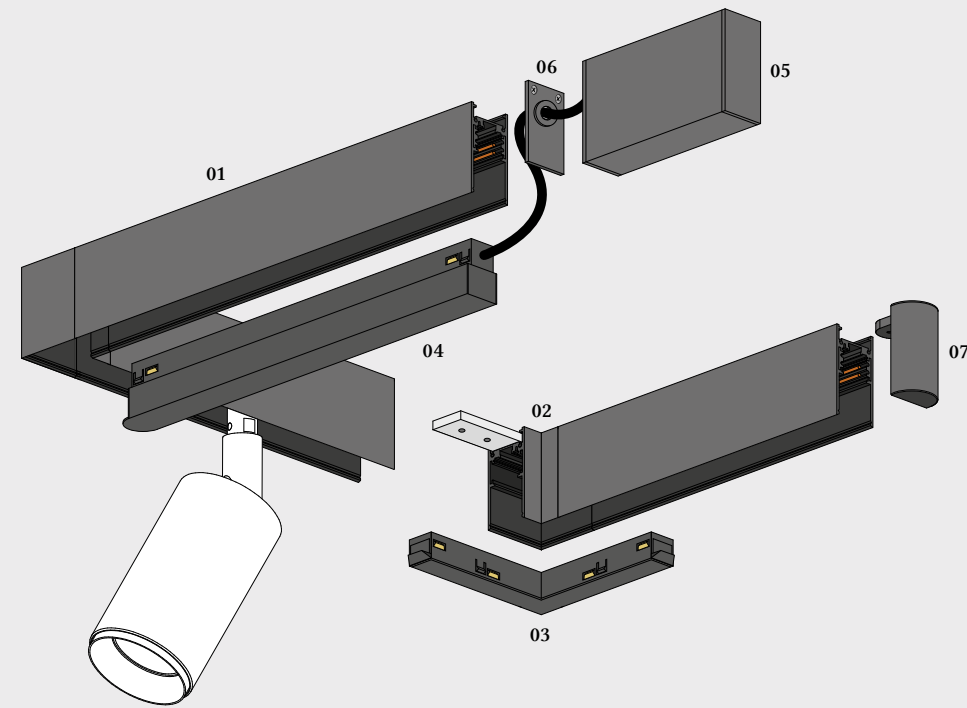

1. Select the track

product	colour	cat. n°	product	colour	cat. n°
MULTITRACK 48V high 1m DALI ⁰¹	black	H0010DA12	MULTITRACK 48V high surface 1m DALI	black	HC010DA12
	white	H0010DA13		white	HC010DA13
	taupe	H0010DA82		taupe	HC010DA82
	terracotta	H0010DA83		terracotta	HC010DA83
MULTITRACK 48V high 2m DALI ⁰¹	black	H0020DA12	MULTITRACK 48V high surface 2m DALI	black	HC020DA12
	white	H0020DA13		white	HC020DA13
	taupe	H0020DA82		taupe	HC020DA82
	terracotta	H0020DA83		terracotta	HC020DA83
MULTITRACK 48V high 3m DALI ⁰¹	black	H0030DA12	MULTITRACK 48V high surface 3m DALI	taupe	HC030DA82
	white	H0030DA13		terracotta	HC030DA83
	taupe	H0030DA82	MULTITRACK 48V up&down suspended 1m DALI	black	US010DA12
	terracotta	H0030DA83	MULTITRACK 48V up&down suspended 2m DALI	black	US020DA12
			MULTITRACK 48V up&down suspended 3m DALI	black	US030DA12

2. Choose the appropriate connector

product	colour	cat. n°
MULTITRACK 48V mounting plate	aluminium	M00MP0011
MULTITRACK 48V surface mechanical straight connector universal	aluminium	MSMUN0011
MULTITRACK 48V up&down suspended mechanical „L” connector universal	black	USVUN0012

product	colour	cat. n°	product	colour	cat. n°
MULTITRACK 48V high surface mechanical „L” connector universal ⁰²	black	HCVUN0012	MULTITRACK 48V power connector straight universal DALI	black	MPSUNDA12
	white	HCVUN0013		white	MPSUNDA13
	taupe	HCVUN0082	MULTITRACK 48V power connector „L” universal DALI ⁰³	black	MPLUNDA12
	terracotta	HCVUN0083		white	MPLUNDA13
MULTITRACK 48V power connector universal DALI	black	MPIUNDA12	MULTITRACK 48V power flexible connector universal DALI	black	MPFUNDA12
	white	MPIUNDA13		white	MPFUNDA13

3. Select the power supply method

3.1. Plug-in driver (drivers mounted within the track):

product	colour	cat. n°	product	colour	cat. n°
MULTITRACK 48V plug-in power supply 100W	black	M00PI1012	MULTITRACK 48V plug-in power supply 250W ⁰⁴	black	M00PI2512
	white	M00PI1013		white	M00PI2513

3.2. Driver:

product	colour	cat. n°	product	colour	cat. n°
MULTITRACK 48V high surface box 0,1m ⁰⁵	black	HCB010012	UNIVERSAL suspended box 1,4m	black	GSB140012
	white	HCB010013		white	GSB140013
	taupe	HCB010082		taupe	GSB140082
	terracotta	HCB010083		terracotta	GSB140083
MULTITRACK 48V high box power supply 100W	black	H0B001012	MULTITRACK 48V power supply 60W		M00000600
	white	H0B001013	MULTITRACK 48V power supply 100W		M00001000
	taupe	H0B001082	MULTITRACK 48V power supply 200W		M00002000
	terracotta	H0B001083	MULTITRACK 48V DIN power supply 120W		M00D11200

4. Match the remaining components: end caps, mounting elements, and other

product	colour	cat. n°	product	colour	cat. n°
MULTITRACK 48V high end cup universal	black	H0CUN0012	MULTITRACK 48V high end cup with hole ⁰⁶	black	H0CHL0012
	white	H0CUN0013		white	H0CHL0013
	taupe	H0CUN0082		taupe	H0CHL0082
	terracotta	H0CUN0083		terracotta	H0CHL0083
MULTITRACK 48V high end cup rounded ⁰⁷	black	H0Z000012	MULTITRACK 48V high end cup rounded with hole	black	H0ZHL0012
	white	H0Z000013		white	H0ZHL0013
	taupe	H0Z000082		taupe	H0ZHL0082
	terracotta	H0Z000083		terracotta	H0ZHL0083
MULTITRACK 48V up&down end cup	black	U0CUN0012	MULTITRACK 48V suspended suspension set 1,4m		MSH140000
MULTITRACK 48V up&down wire	black	UW0000012	MULTITRACK 48V wire crimping accessory		MWA000000

Extra

product	colour	cat. n°
MULTITRACK 48V plug-in Aqsmart	black	M00PIAS12
	white	M00PIAS13

Multitrack system can be controlled wirelessly. For wireless control Aqsmart module is needed for each group of luminaires connected to the track. Regardless of Aqsmart module, the luminaire must be in the DALI version. One device can control up to 64 fixtures, which can be divided into a maximum of 8 groups.

Scheme of the HIGH MULTITRACK

surface/suspended system

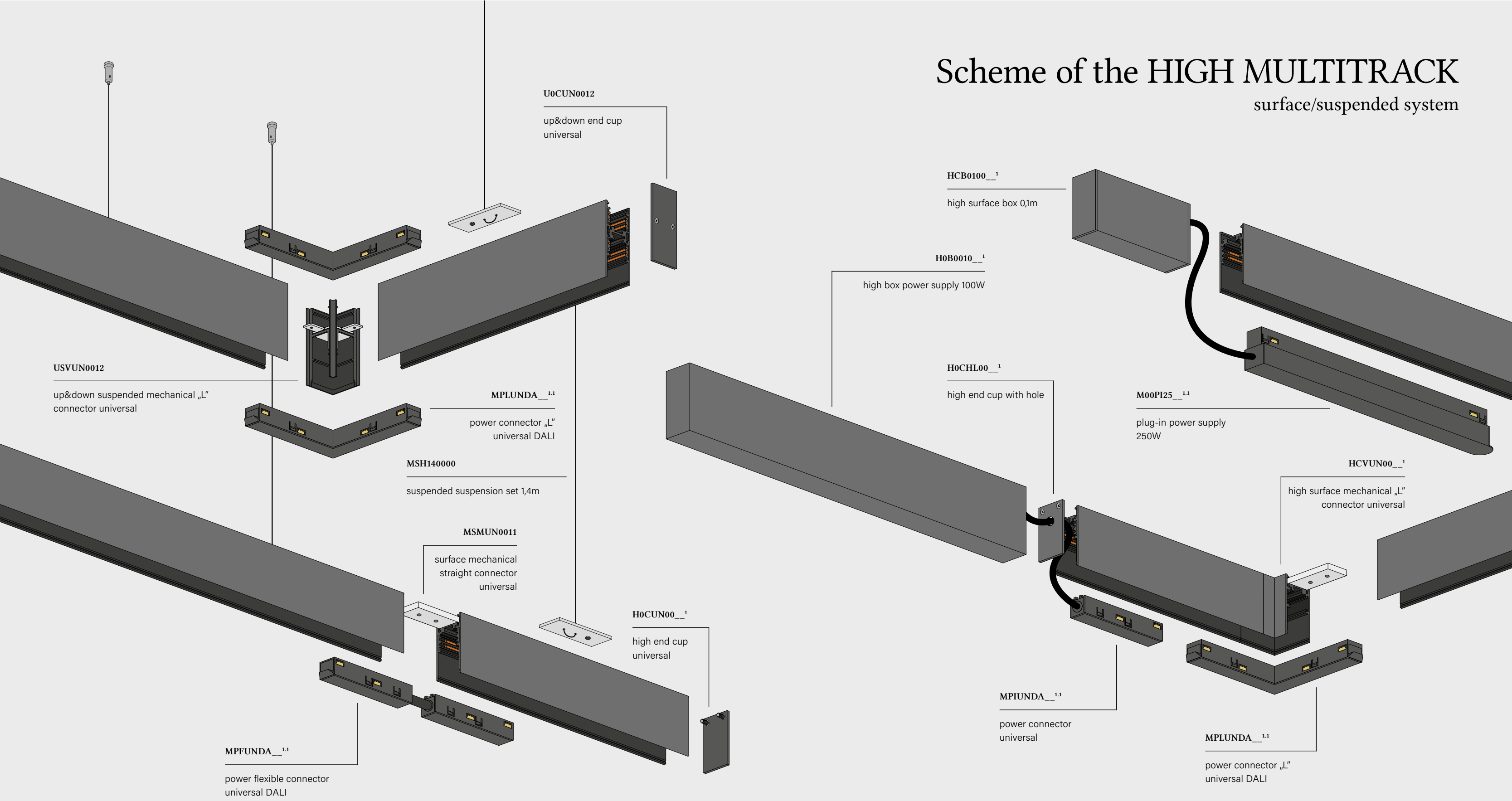

Easy to complete HIGH MULTITRACK

The recessed set can be designed in 4 simple steps

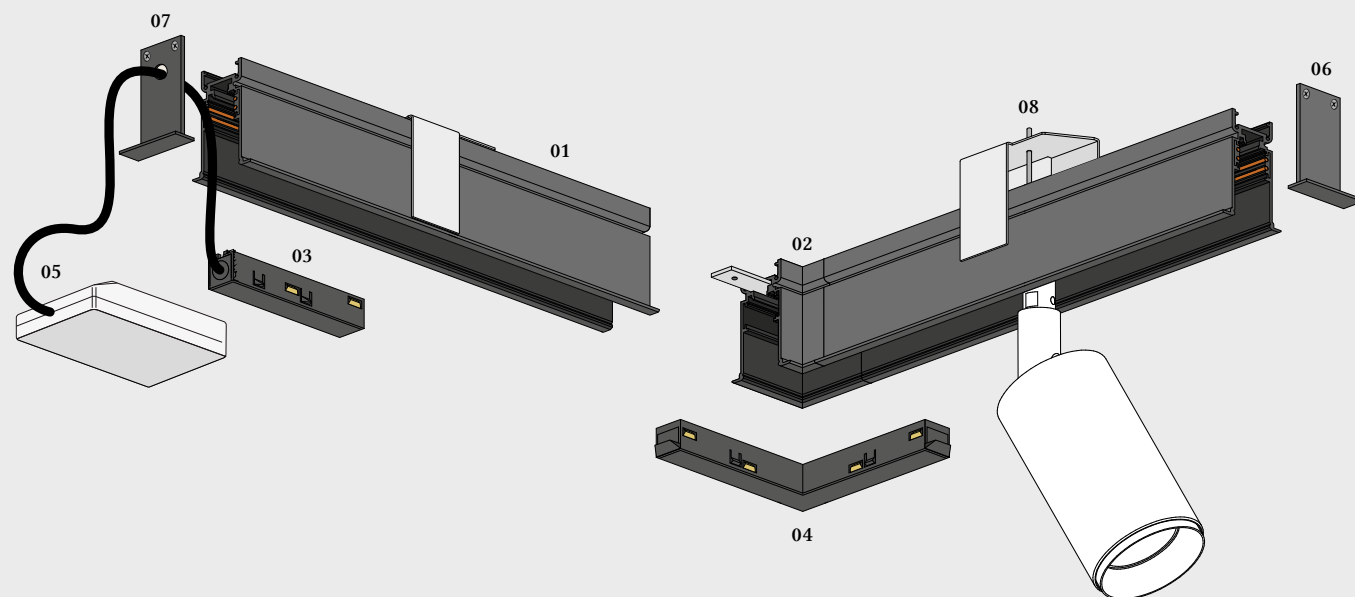

1. Select the track

product	colour	cat. n°	product	colour	cat. n°
MULTITRACK 48V high recessed 1m DALI	black	HR010DA12	MULTITRACK 48V high trim recessed 1m DALI ⁰¹	black	CR010DA12
	white	HR010DA13		white	CR010DA13
MULTITRACK 48V high recessed 2m DALI	black	HR020DA12	MULTITRACK 48V high trim recessed 2m DALI ⁰¹	black	CR020DA12
	white	HR020DA13		white	CR020DA13
MULTITRACK 48V high recessed 3m DALI	black	HR030DA12	MULTITRACK 48V high trim recessed 3m DALI ⁰¹	black	CR030DA12
	white	HR030DA13		white	CR030DA13

2. Choose the appropriate connector

product	colour	cat. n°
MULTITRACK 48V mechanical straight connector universal	aluminium	M0MUN0011
MULTITRACK 48V high recessed mechanical „L” connector	black	HRV000012
	white	HRV000013
MULTITRACK 48V high recessed mechanical wall-ceiling universal	black	HRWUN0012
	white	HRWUN0013
MULTITRACK 48V high trim recessed mechanical „L” connector ⁰²	black	CRV000012
	white	CRV000013

product	colour	cat. n°	product	colour	cat. n°
MULTITRACK 48V power connector universal DALI ⁰³	black	MPIUNDA12	MULTITRACK 48V power connector „L” universal DALI ⁰⁴	black	MPLUNDA12
	white	MPIUNDA13		white	MPLUNDA13
MULTITRACK 48V power connector straight universal DALI	black	MPSUNDA12	MULTITRACK 48V power flexible connector universal DALI	black	MPFUNDA12
	white	MPSUNDA13		white	MPFUNDA13

3. Select the power supply method

3.1. Plug-in driver (drivers mounted within the track):

product	colour	cat. n°	product	colour	cat. n°
MULTITRACK 48V plug-in power supply 100W	black	M00PI1012	MULTITRACK 48V plug-in power supply 250W	black	M00PI2512
	white	M00PI1013		white	M00PI2513

3.2. Driver:

product	cat. n°
MULTITRACK 48V power supply 60W ⁰⁵	M00000600
MULTITRACK 48V power supply 100W ⁰⁵	M00001000
MULTITRACK 48V power supply 200W ⁰⁵	M00002000
MULTITRACK 48V DIN power supply 120W	M00DI1200

4. Match the remaining components: end caps, mounting elements, and other

product	colour	cat. n°	product	colour	cat. n°
MULTITRACK 48V high end cup universal	black	H0CUN0012	MULTITRACK 48V high end cup with hole	black	H0CHL0012
	white	H0CUN0013		white	H0CHL0013
	taupe	H0CUN0082		taupe	H0CHL0082
	terracotta	H0CUN0083		terracotta	H0CHL0083

product	colour	cat. n°
MULTITRACK 48V high trim end cup ⁰⁶	black	C0C000012
	white	C0C000013
MULTITRACK 48V high trim end cup with hole ⁰⁷	black	C0CHL0012
	white	C0CHL0013
MULTITRACK 48V high recessed mounting template		HRQ000000
MULTITRACK 48V high recessed mounting cover 2m	black	HRD300012
MULTITRACK 48V high recessed mask cover 3m	black	HRN200012
	white	HRN200013
MULTITRACK 48V high trim recessed mounting foot set ⁰⁸	aluminium	CRE000011
MULTITRACK 48V wire crimping accessory		MWA000000

Extra

product	colour	cat. n°
MULTITRACK 48V plug-in Aqsmart	black	M00PIAS12
	white	M00PIAS13

Multitrack system can be controlled wirelessly. For wireless control Aqsmart module is needed for each group of luminaires connected to the track. Regardless of Aqsmart module, the luminaire must be in the DALI version. One device can control up to 64 fixtures, which can be divided into a maximum of 8 groups.

M0MUN0011

mechanical straight connector
universal

MPSUNDA__1

power connector straight
universal

CRV0000__1

high trim recessed
mechanical „L” connector

CRE000011

high trim recessed
mounting foot set

C0C0000__1

high trim end cup

H0CHL00__1

high end cup with hole

M0000__200

power supply

HRV0000__1

high recessed mechanical
„L” connector

MPIUNDA__1

power connector
universal

C0CHL00__1

high trim end cup with hole

HRQ000000

high recessed
mounting template

HRWUN00__1

high recessed mechanical
wall-ceiling universal

H0CUN00__1

high end cup
universal

MPLUNDA__1

power connector „L”
universal DALI

HRN200012

high recessed mask cover 3m

MPFUNDA__1

power flexible
connector
universal DALI

Scheme of the HIGH MULTITRACK recessed system

MICRO TRACK



RAFTER mini points move LED microtrack | RAFTER mini points LED microtrack



MICROTRACK is a compact, low-voltage track system with a miniature profile, designed for discreet installation along ceilings and walls. It is available in recessed and surface-mounted versions. The same components are used for both ON/OFF and DALI versions, simplifying the selection process.

Curved tracks available within the MICROTRACK system allow for the creation of soft, visually engaging compositions. MICROTRACK is well suited to spaces where installation discretion is a priority.



Easy to complete MICROTRACK

The surface and recessed set can be designed in 4 simple steps

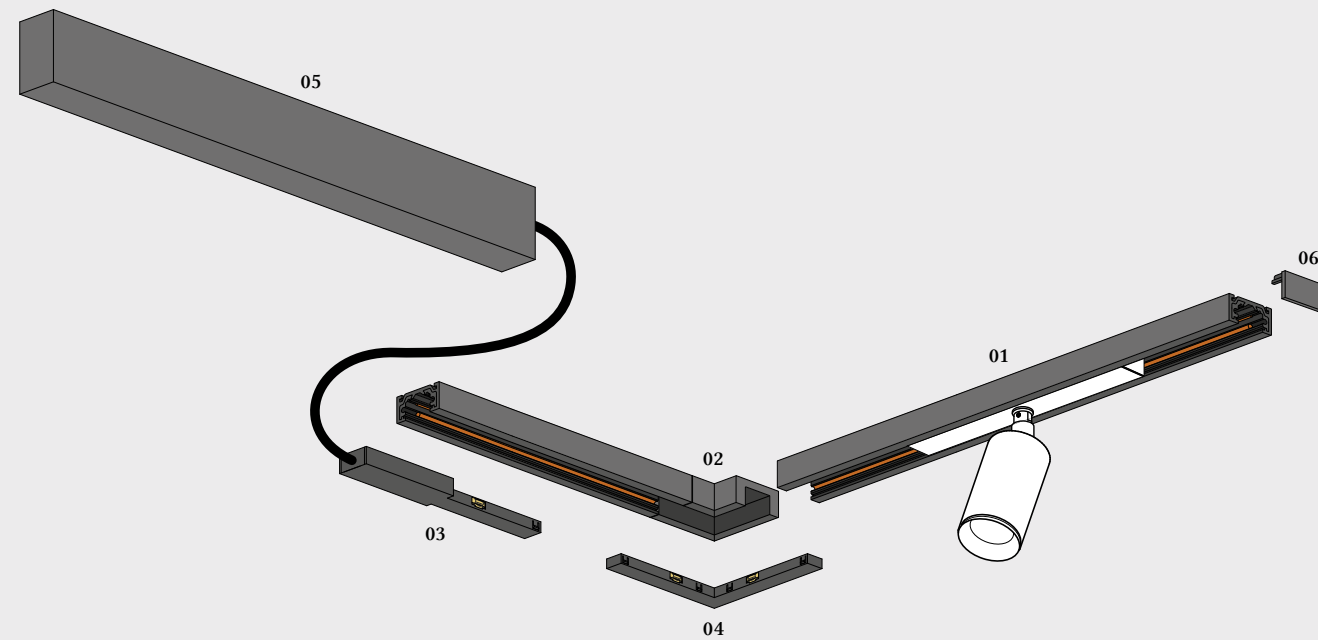

1. Select the track

product	colour	cat. n°	product	colour	cat. n°
MICROTRACK 48V surface 1m DALI ⁰¹	black	OC010DA12	MICROTRACK 48V recessed 1m DALI	black	OR010DA12
MICROTRACK 48V surface 2m DALI ⁰¹	black	OC020DA12	MICROTRACK 48V recessed 2m DALI	black	OR020DA12
product			product	colour	cat. n°
MICROTRACK 48V surface round connector radius 0,3 DALI				black	OCRR3DA12
MICROTRACK 48V surface round connector radius 0,5 DALI				black	OCRR5DA12

2. Choose the appropriate connector

product	colour	cat. n°
MICROTRACK 48V surface mechanical "L" connector ⁰²	black	OCVUN0012
MICROTRACK 48V wall ceiling mechanical connector	black	OXJUN0012
MICROTRACK 48V power end cup 2,5m DALI black	black	OPC25DA12
MICROTRACK 48V power end cup DALI black ⁰³	black	OPC00DA12
MICROTRACK 48V power connector straight universal DALI	black	OPSUNDA12
MICROTRACK 48V power connector "L" universal ⁰⁴	black	OPLUN0012
MICROTRACK 48V wall ceiling connector universal DALI	black	OXIUNDA12
MICROTRACK 48V flexible connector universal DALI	black	O0FUNDA12

3. Select the power supply method

product	colour	cat. n°
MICROTRACK 48V power box power supply 100W ⁰⁵	black	M0B001012
MULTITRACK 48V power supply 60W		M00000600
MULTITRACK 48V power supply 100W		M00001000
MULTITRACK 48V power supply 200W		M00002000
MULTITRACK 48V DIN power supply 120W		M00DI1200

4. Match the remaining components: end caps, mounting elements, and other

product	colour	cat. n°
MICROTRACK 48V end cup ⁰⁶	black	O0CUN0012
MICROTRACK 48V recessed end cup	black	ORCUN0012

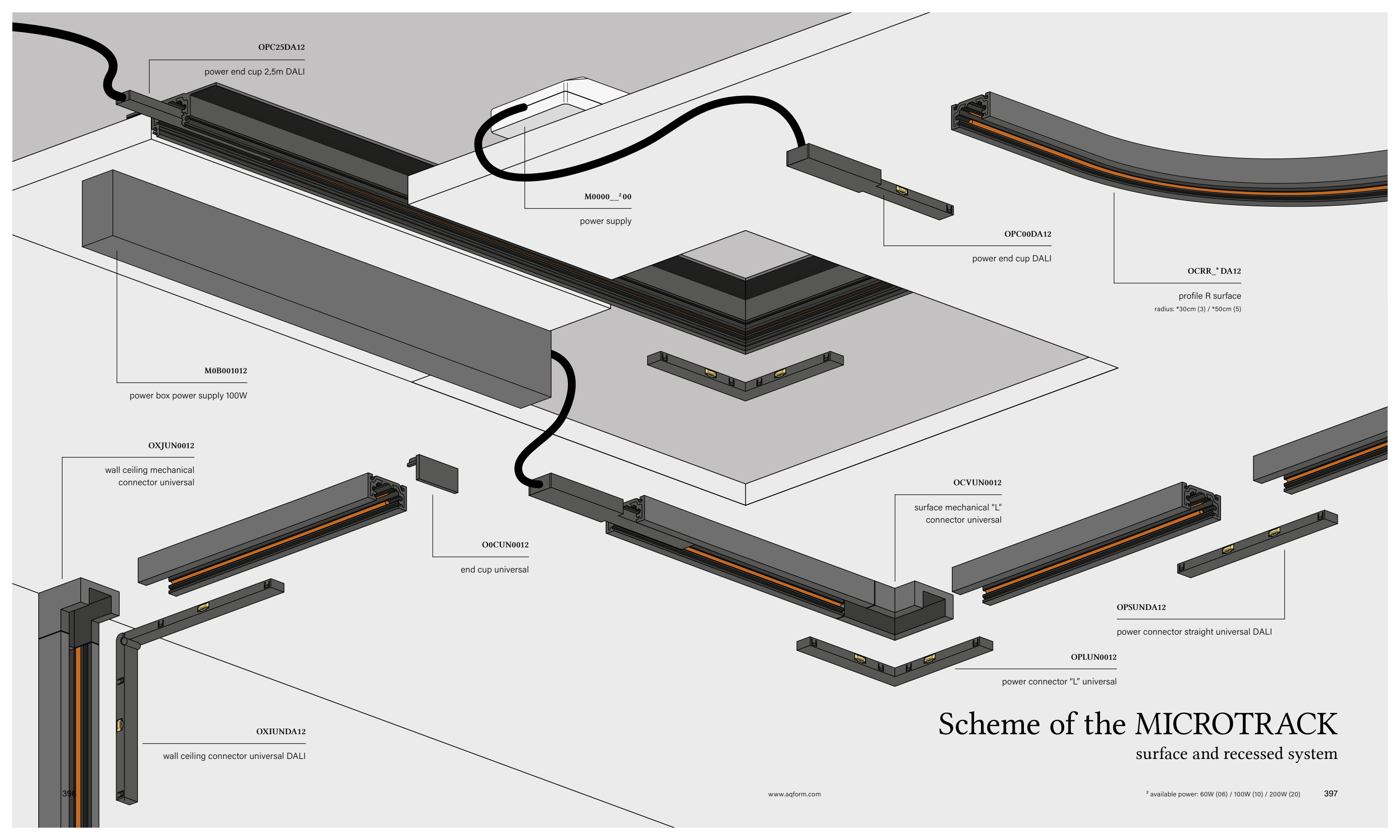

Scheme of the MICROTRACK surface and recessed system

3F TRACK

TRACK 3F & DALI are 230V track systems that do not require an additional power supply. The 3F variant allows lighting to be divided into three independently controlled circuits within a single installation.

The DALI version enables group or individual luminaire control, with smooth dimming and scene programming. Available connectors allow very long sections to be run and branches to be designed in various directions. Thanks to the 230V voltage, a large number of luminaires can be connected within one system. Luminaires in the 3F and DALI tracks can be easily repositioned and removed.

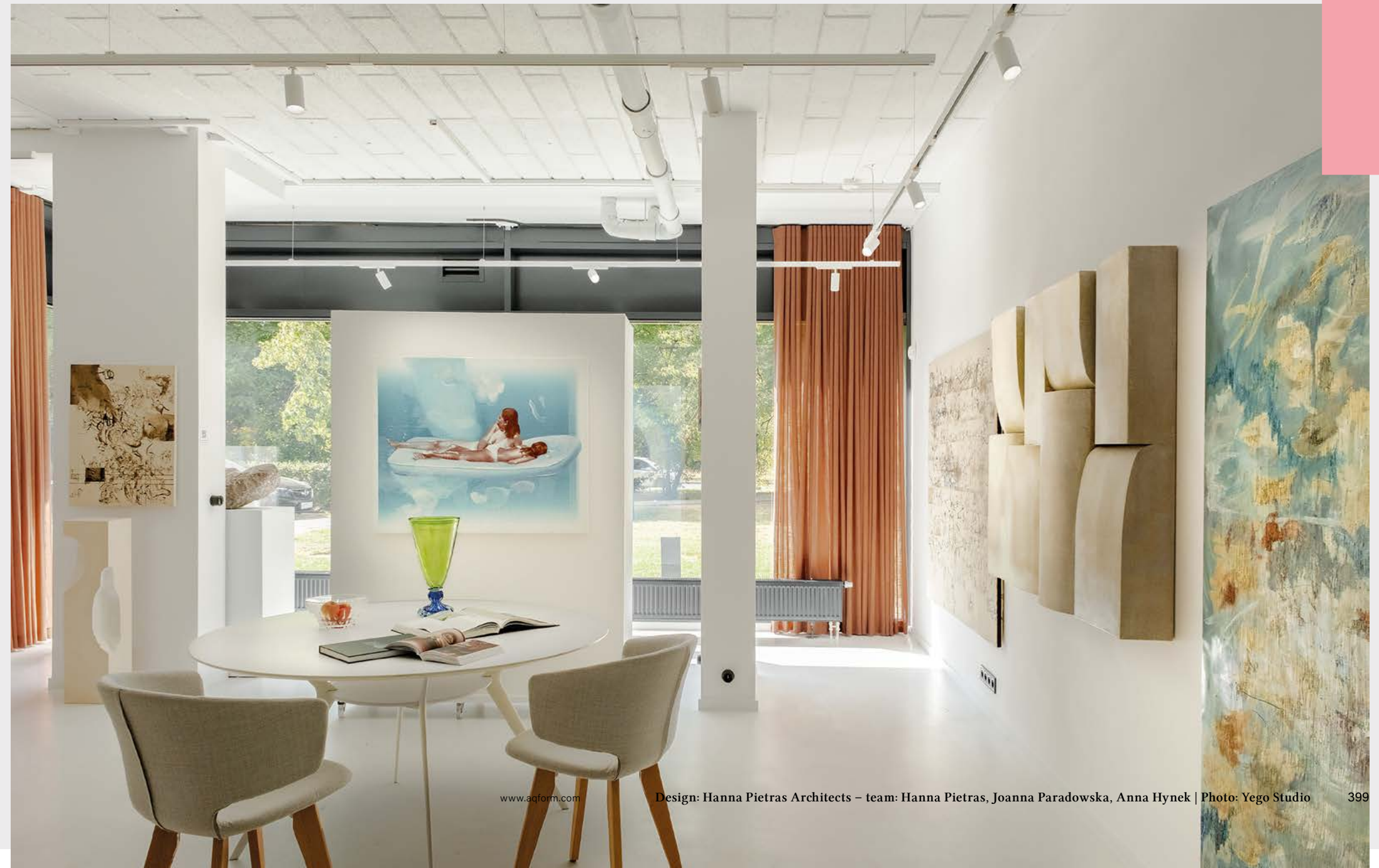

Easy to complete 3F TRACK

The surface/suspended and recessed set can be designed in 4 simple steps

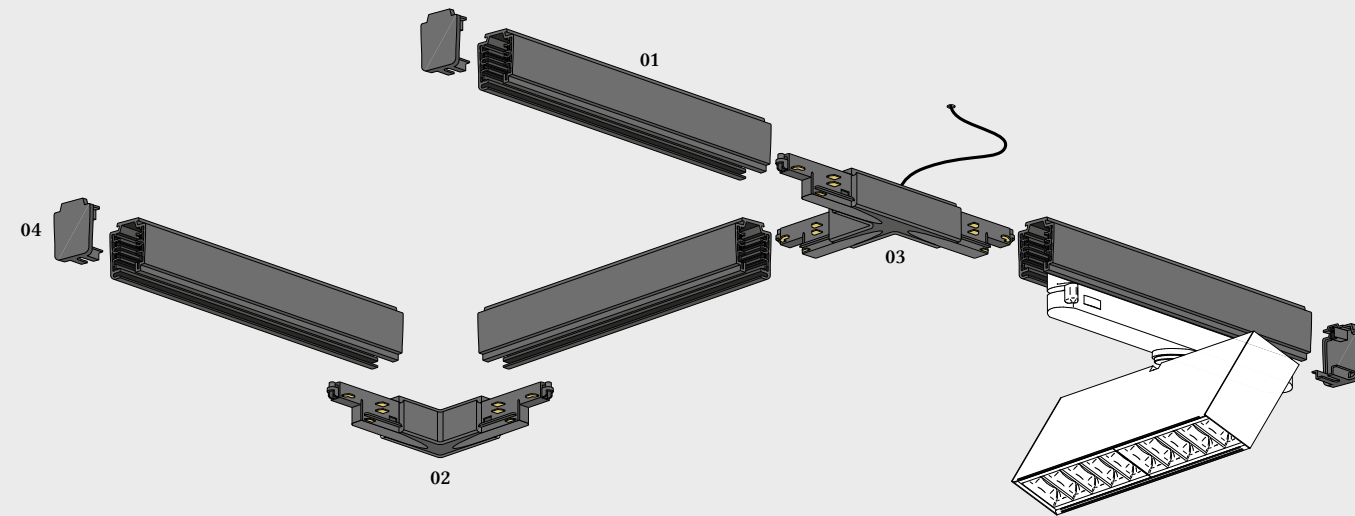

1. Select the track

product	colour	cat. n°	product	colour	cat. n°
TRACK 3F 230V recessed 1m Phase-Control	black	TR010PH12	TRACK 3F 230V recessed 1m DALI	black	TR010DA12
	white	TR010PH13		white	TR010DA13
TRACK 3F 230V recessed 2m Phase-Control	black	TR020PH12	TRACK 3F 230V recessed 2m DALI	black	TR020DA12
	white	TR020PH13		white	TR020DA13
TRACK 3F 230V surface 1m Phase-Control	black	TC010PH12	TRACK 3F 230V surface 1m DALI ⁰¹	black	TC010DA12
	white	TC010PH13		white	TC010DA13
TRACK 3F 230V surface 2m Phase-Control	black	TC020PH12	TRACK 3F 230V surface 2m DALI ⁰¹	black	TC020DA12
	white	TC020PH13		white	TC020DA13
TRACK 3F 230V surface 3m Phase-Control	black	TC030PH12	TRACK 3F 230V surface 3m DALI ⁰¹	black	TC030DA12
	white	TC030PH13		white	TC030DA13

2. Choose the appropriate connector

product	colour	cat. n°	product	colour	cat. n°
TRACK 3F 230V adapter universal Phase-Control	black	TA0UNPH12	TRACK 3F 230V power connector straight universal DALI	black	TPSUNDA12
	white	TA0UNPH13		white	TPSUNDA13
TRACK 3F 230V adapter universal DALI	black	TA0UNDA12	TRACK 3F 230V power connector "L" universal Phase-Control	black	TPLUNPH12
	white	TA0UNDA13		white	TPLUNPH13
TRACK 3F 230V adapter power universal Phase-Control	black	TAPUNPH12	TRACK 3F 230V power connector "L" universal DALI ⁰²	black	TPLUNDA12
	white	TAPUNPH13		white	TPLUNDA13
TRACK 3F 230V power end cup left (A) Phase-Control	black	TPCLAPH12	TRACK 3F 230V power connector "T" (A) Phase-Control	black	TPTGAPH12
	white	TPCLAPH13		white	TPTGAPH13
TRACK 3F 230V power end cup left (A) DALI	black	TPCLADA12	TRACK 3F 230V power connector "T" (A) DALI ⁰³	black	TPTGADA12
	white	TPCLADA13		white	TPTGADA13
TRACK 3F 230V power end cup right (B) Phase-Control	black	TPCRBPH12	TRACK 3F 230V power connector "T" (B) Phase-Control	black	TPTGBPH12
	white	TPCRBPH13		white	TPTGBPH13
TRACK 3F 230V power end cup right (B) DALI	black	TPCRBDA12	TRACK 3F 230V power connector "T" (C) Phase-Control	black	TPTGCPH12
	white	TPCRBDA13		white	TPTGCPH13
TRACK 3F 230V power flexible connector universal Phase-Control	black	TPFUNPH12	TRACK 3F 230V power connector "T" (D) Phase-Control	black	TPTGDPH12
	white	TPFUNPH13		white	TPTGDPH13
TRACK 3F 230V power connector straight universal Phase-Control	black	TPSUNPH12	TRACK 3F 230V power connector "X" universal Phase-Control	black	TPXUNPH12
	white	TPSUNPH13		white	TPXUNPH13

product	colour	cat. n°
UNIVERSAL suspended box 1,4m	black	GSB140012
	white	GSB140013
TRACK 3F 230V power internal connector universal DALI	multicolour	TPKUNDA98
TRACK 3F 230V power internal connector universal Phase-Control	multicolour	TPKUNPH98

3. Match the remaining components: end caps, mounting elements, and other

product	colour	cat. n°	product	colour	cat. n°
TRACK 3F 230V end cup universal Phase-Control	black	T0CUNPH12	TRACK 3F 230V wire suspension set universal	black	TWHUN0012
	white	T0CUNPH13		white	TWHUN0013
TRACK 3F 230V end cup universal DALI ⁰⁴	black	T0CUNDA12	TRACK 3F 230V mask cover 2m	black	T0D000012
	white	T0CUNDA13		white	T0D000013
TRACK 3F 230V surface suspension set mounting	black	TCHMT0012	TRACK 3F 230V recessed mask cover	black	TRD000012
	white	TCHMT0013		white	TRD000013

Scheme of the 3F TRACK

recessed/surface/suspended system

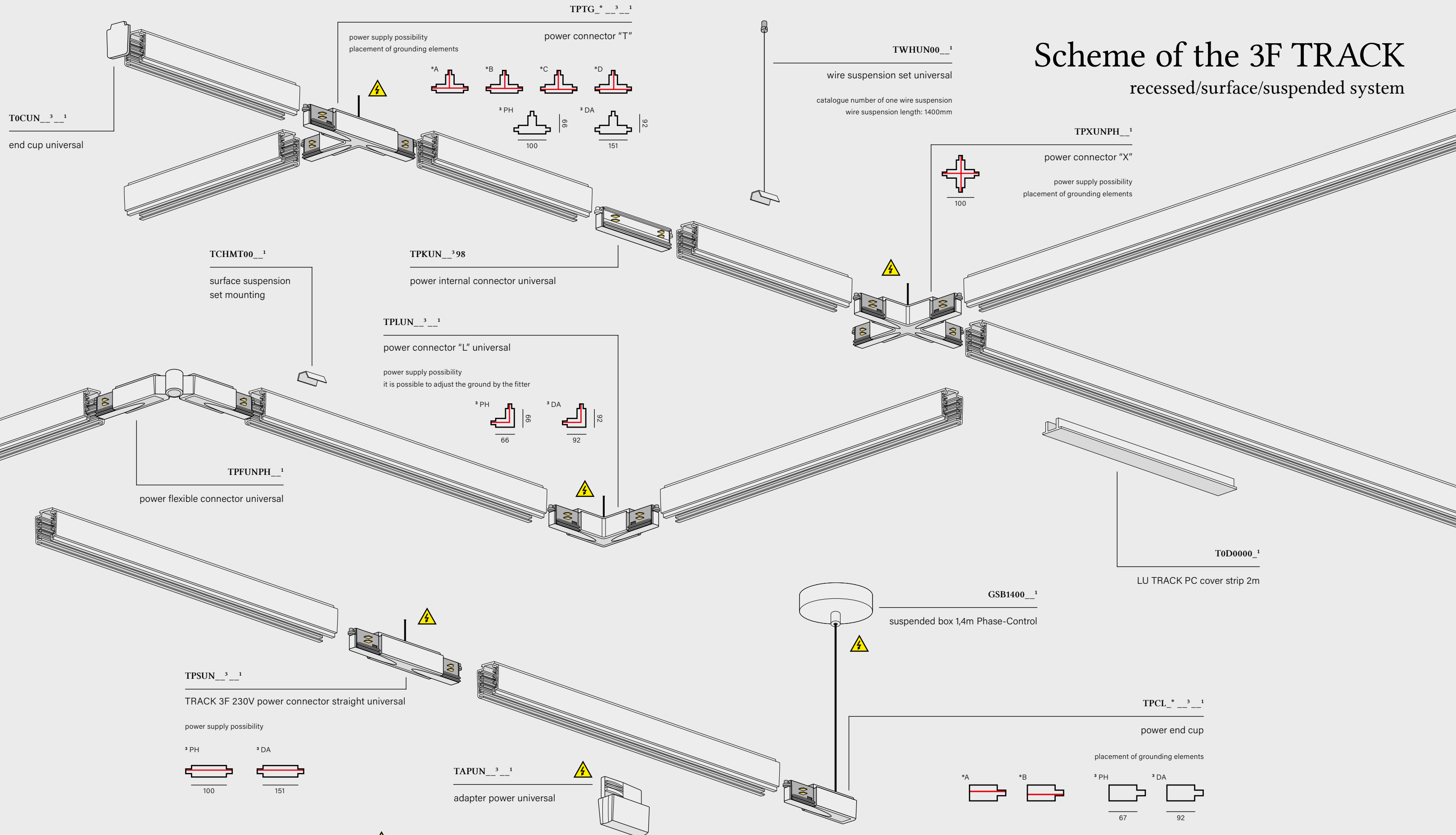



LUMINARIES

Hotel-T, Waremę



MODERN BALL simple midi LED suspended track

Photo: I am Liz



PET midi LED track

PAN TU NIE STAJ – cultural-café-shop space, Łódź

AQForm track-compatible fixtures create a clear and cohesive set of solutions: choose the shape and power to match the role of light, while maintaining consistent finishes and the flexibility to quickly reconfigure your layout. Perfect for everything from homes to commercial spaces.

READY FOR CHANGE

QRLED next

QRLED next microtrack | suspended microtrack

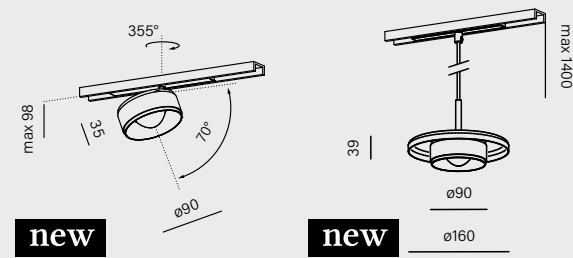

cat. n°	cat. n°
16521-M930-W3-00-12	16522-M930-W3-00-12
power:	6W (L) 9W (M)
flux:	834lm - 1134lm
optics:	52° (W_)
CCT:	2700K (27) 3000K (30) 4000K (40)
control:	ON/OFF (00) DALI (DA)

QRLED next: integrated LED and refined optics with a glass lens that ensures low glare. The spotlight with a tiltable module and the suspended version allow precise accent lighting or illumination of specific zones, from individual details to work surfaces.

Design: F-Studio | Photo: Dariusz Jarzabek | Lighting design: ATRIA Sztuka Światła



QRLED next track | multitrack | suspended multitrack | high multitrack

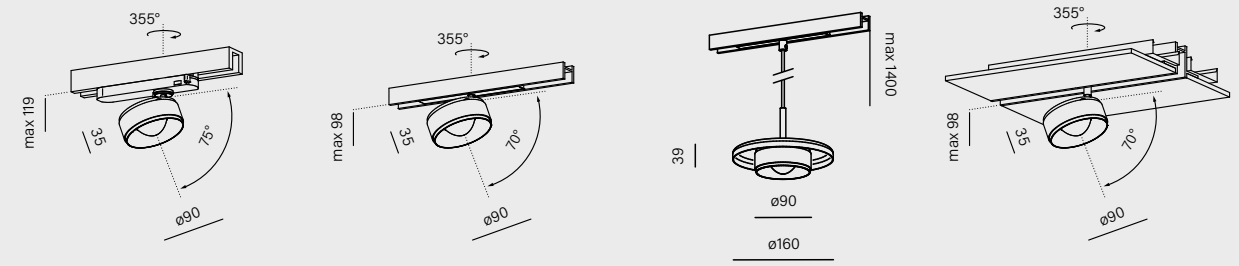

cat. n°	cat. n°	cat. n°	cat. n°
16486-M930-W3-00-12	16484-M930-W3-00-12	16485-M930-W3-00-12	16483-M930-W3-00-12
power:	6W (L) 9W (M)		
flux:	834lm - 1134lm		
optics:	52° (W_)		
CCT:	2700K (27) 3000K (30) 4000K (40)		
control:	ON/OFF (00) DALI (DA)	ON/OFF (00) ON/OFF second circuit (01) DALI (DA)	

luminaire finishes

- white -13 ○
- black -12 ●
- burgundy -86 ●
- terracotta -83 ●
- sandy -87 ●
- taupe -82 ●
- grey -84 ●
- gold -19 ●
- mix -06 ●

main material

aluminium | optical glass | steel (QRLED next suspended)

recessed p. 062-066
surface p. 132-136
suspended p. 278
track
systems p. 584



TRIBA_family



In TRIBA, the shared form brings visual order to the entire set, regardless of the chosen variant. LED modules provide directional light with low glare and are suited for precise illumination. The E27 version allows for the use of decorative bulbs, adding a visual accent without departing from the same design language. One family, a cohesive appearance and the flexibility to tailor the role of the lighting to its context.

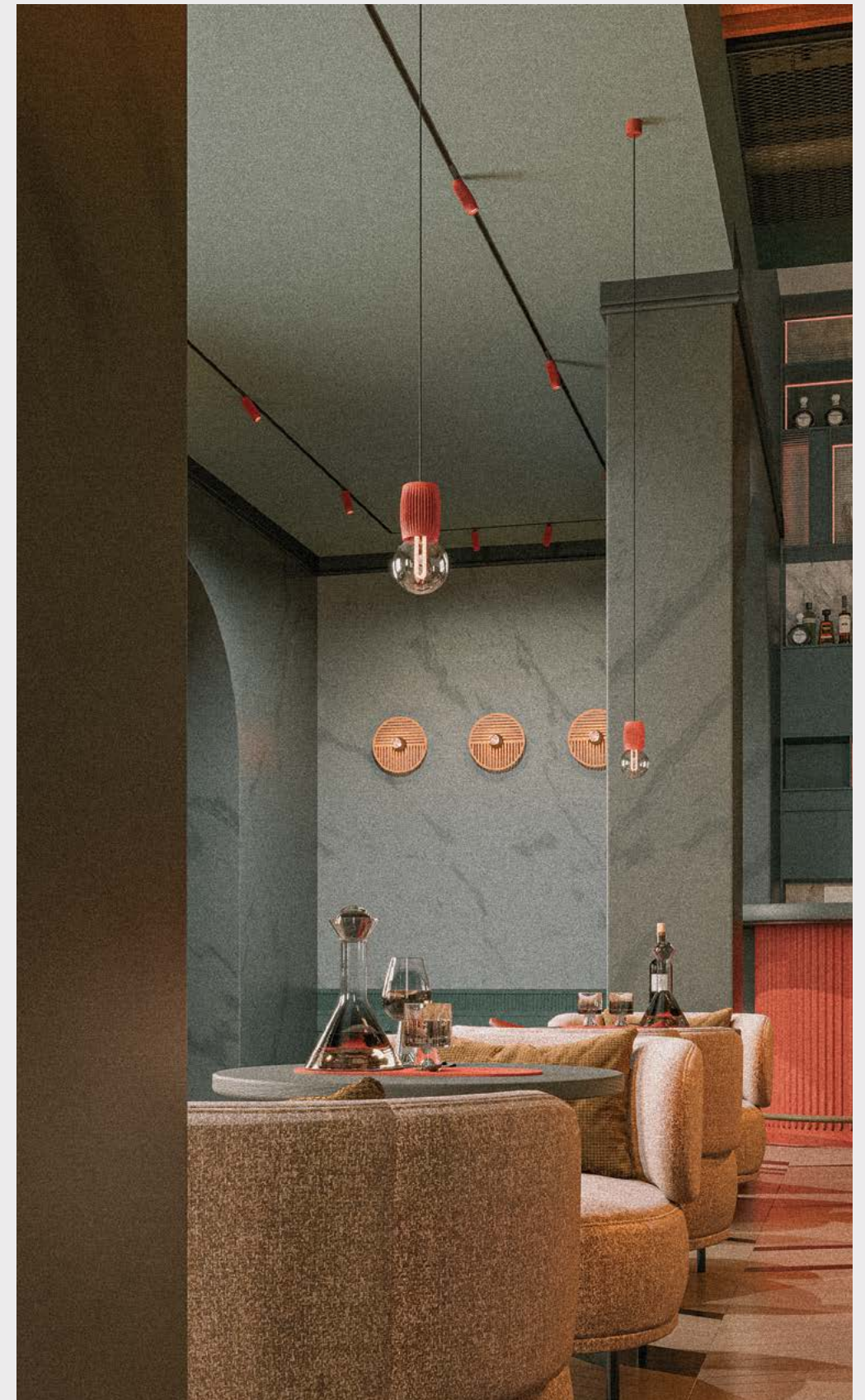

TRIBA midi 9 E27 suspended track

La Muse de Marcel, Brugge

TRIBA midi LED track

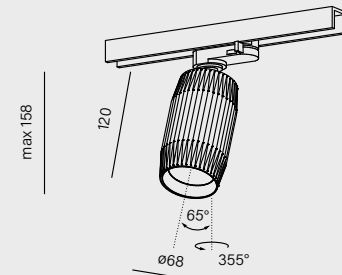

new

cat. n°	16479-M930-WB-00-12
power:	8.5W (M)
flux:	1149lm
optics:	18° (S_) 35° (F_) 50° (W_)
CCT:	2700K (27) 3000K (30) 4000K (40)
control:	ON/OFF (00) Phase-Control (PH) DALI (DA) Aqsmart (DB)

*the protection class depends on the luminaire control version

Design: Corona | Photo: I am Liz

TRIBA midi GU10 track | suspended track

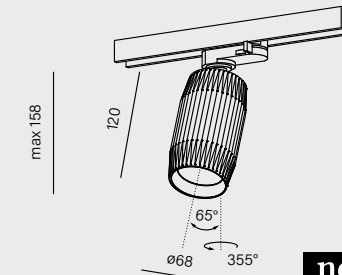

new

cat. n°	16534-G000-00-PH-12	16533-G000-00-PH-12	16515-E000-00-PH-12
power:		max: 50W	
control:		Phase-Control (PH)	

light source not included
TRIBA GU10 includes a ring in the colour of the luminaire

accessory



Not applicable to the E27 version



TRIBA midi E27 suspended track

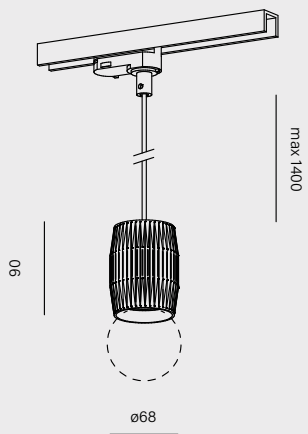

new

cat. n°	16515-E000-00-PH-12
power:	max: 50W
control:	Phase-Control (PH)

- | | |
|--|---------------------------|
| ring finishes
only for TRIBA LED | luminaire finishes |
| white -_W ○ | white -13 ○ |
| black -_B ● | black -12 ● |
| natural -_N ● | brutal -85 ● |
| burgundy -_U ● | burgundy -86 ● |
| terracotta -_R ● | terracotta -83 ● |
| sandy -_D ● | sandy -87 ● |
| taupe -_T ● | taupe -82 ● |
| grey -_A ● | grey -84 ● |
| gold -_G ● | gold -19 ● |

the brutal (-85) color variant of the luminaires can only be ordered with neutral optics (_N)

main material
aluminium

recessed p. 090
surface p. 148-152
suspended p. 282
track
wall p. 470
systems p. 584

TRIBA

PRECISION AND FLEXIBILITY

TRIBA is a multi-award-winning family of luminaires known for its distinctive, decorative form and refined proportions. It is available in LED versions (low glare, directional light) as well as E27 which allows for the use of decorative bulbs as subtle design accents.



recessed p. 090
 surface p. 148-152
 suspended p. 282
track
 wall p. 470
 systems p. 584



TRIBA mini LED
 microtrack | suspended microtrack

TRIBA mini LED
 multitrack | suspended multitrack | high multitrack

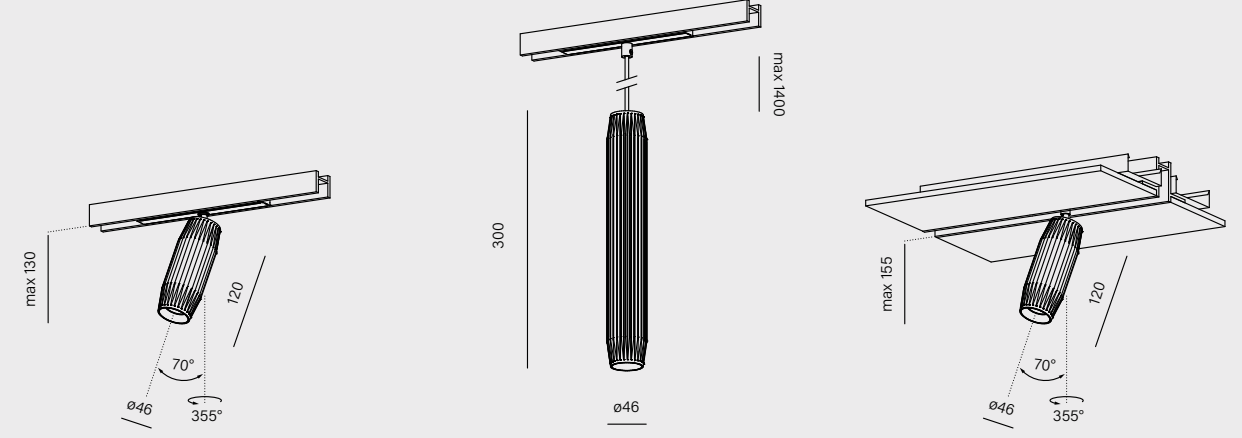
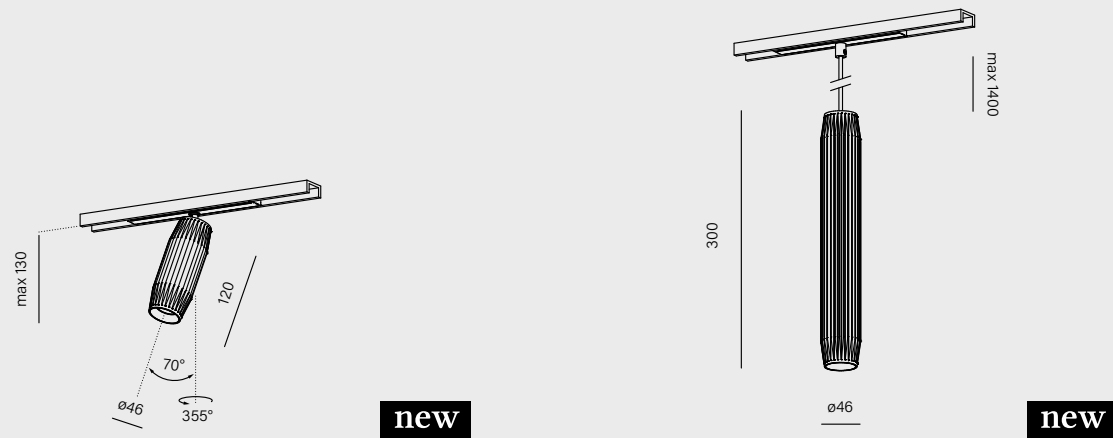

cat. n°	16530-M930-WB-00-12	16520-M930-WB-00-12
power:	4.5W (M)	
flux:	543lm	
optics:	20° (S_) 41° (W_)	
CCT:	2700K (27) 3000K (30) 4000K (40)	
control:	ON/OFF (00) ON/OFF second circuit (01) DALI (DA)	

cat. n°	16474-M930-WB-00-12	16473-M930-WB-00-12	16475-M930-WB-00-12
power:		4.5W (M)	
flux:		543lm	
optics:		20° (S_) 41° (W_)	
CCT:		2700K (27) 3000K (30) 4000K (40)	
control:	ON/OFF (00) ON/OFF second circuit (01) DALI (DA)		

accessory
 honeycomb



- ring finishes**
- white -_W ○
- black -_B ●
- natural -_N ●
- burgundy -_U ●
- terracotta -_R ●
- sandy -_D ●
- taupe -_T ●
- grey -_A ●
- gold -_G ●
- luminaire finishes**
- white -13 ○
- black -12 ●
- brutal -85 ●
- burgundy -86 ●
- terracotta -83 ●
- sandy -87 ●
- taupe -82 ●
- grey -84 ●
- gold -19 ●

The brutal (-85) color variant of the luminaires can only be ordered with neutral optics (_N)

main material
 aluminium



PET mini



PET mini LED
track | microtrack | suspended microtrack

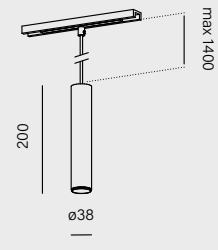
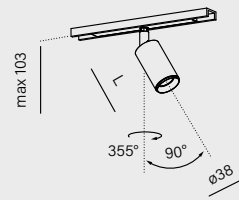
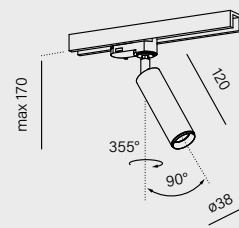

cat. n°	length	cat. n°	cat. n°
16358-M930-WB-00-12	70mm	16436-M930-WB-00-12	16434-M930-WB-00-12
	120mm	16524-M930-WB-00-12	
power:		4.5W (M)	
flux:		543lm	
optics:		20° (S_) 41° (W_)	
CCT:		2700K (27) 3000K (30) 4000K (40)	
control:	ON/OFF (00)	ON/OFF (00) DALI (DA)	

PET mini is a compact luminaire with a timeless form. It delivers precise, directional light and remains a discreet element of the interior, making it well suited to denser layouts and smaller spaces.

PET mini LED
multitrack | suspended multitrack | high multitrack

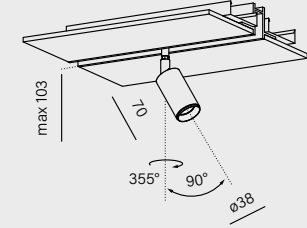
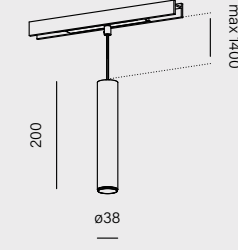
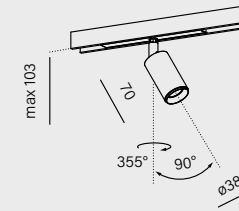

cat. n°	cat. n°	cat. n°
16367-M930-WB-00-12	16369-M930-WB-00-12	16435-M930-WB-00-12
power:	4.5W (M)	
flux:	543lm	
optics:	20° (S_) 41° (W_)	
CCT:	2700K (27) 3000K (30) 4000K (40)	
control:	ON/OFF (00) ON/OFF second circuit (01) DALI (DA)	

accessory
honeycomb



- | ring finishes | luminaire finishes |
|------------------|--------------------|
| white -_W ○ | white -13 ○ |
| black -_B ● | black -12 ● |
| natural -_N ● | brutal -85 ● |
| burgundy -_U ● | burgundy -86 ● |
| terracotta -_R ● | terracotta -83 ● |
| sandy -_D ● | sandy -87 ● |
| taupe -_T ● | taupe -82 ● |
| grey -_A ● | grey -84 ● |
| gold -_G ● | gold -19 ● |

The brutal (-85) color variant of the luminaires can only be ordered with neutral optics (_N)

main material
aluminium





PET



PET midi LED track

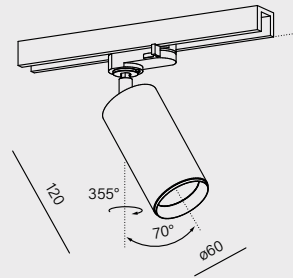

cat. n°

16362-M930-WB-00-12

power: 8.5W (M)

flux: 1149lm

optics: 18° (S_) | 35° (F_) | 50° (W_)

CCT: 2700K (27) | 3000K (30) | 4000K (40)

control: ON/OFF (00) | Phase-Control (PH)¹ | DALI (DA) | AQsmart (DB)



PET maxi LED track

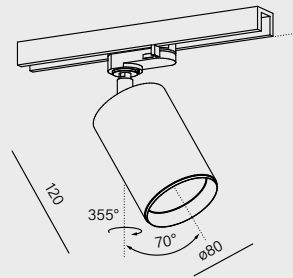

cat. n°

16370-M930-FB-00-12

power: 11.5W (L) | 17W (M) | 20.5W (H)

flux: 1617lm - 2678lm

optics: 19° (S_) | 32° (F_) | 63° (W_)

CCT: 2700K (27) | 3000K (30) | 4000K (40)

control: ON/OFF (00) | Phase-Control (PH)¹ | DALI (DA) | AQsmart (DB)



PET GU10 track

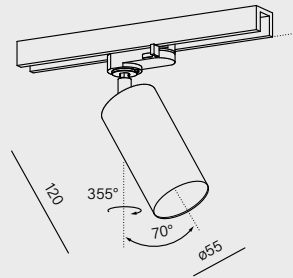

cat. n°

12548-G000-00-PH-12

power: max: 50W

control: Phase-Control (PH)



light source not included

PET (midi) is the larger variant within this family. It delivers high-quality directional light that easily illuminates larger zones, from residential interiors to exhibition spaces, while maintaining a timeless form and low glare.

recessed p. 092
surface p. 162-164
suspended p. 304-306
track
wall p. 472
exterior p. 538
systems p. 584



PET midi LED microtrack | multitrack | high multitrack

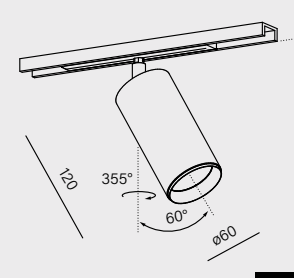

new

cat. n°

16523-M930-WB-00-12

power:

flux:

optics:

CCT:

control:

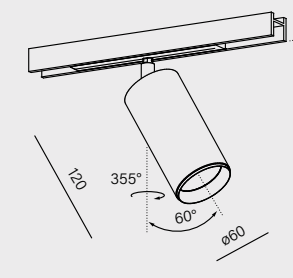

cat. n°

16366-M930-WB-00-12

power: 8.5W (M)

flux: 1149lm

optics: 18° (S_) | 35° (F_) | 50° (W_)

CCT: 2700K (27) | 3000K (30) | 4000K (40)

control: ON/OFF (00) | ON/OFF second circuit (01) | DALI (DA)

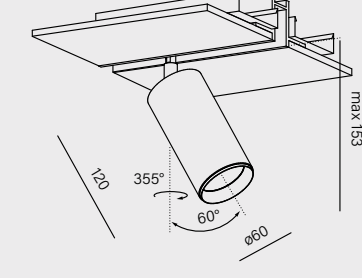

cat. n°

16433-M930-WB-00-12

power:

flux:

optics:

CCT:

control:



- | ring finishes | luminaire finishes |
|------------------|--------------------|
| only for PET LED | |
| white -_W ○ | white -13 ○ |
| black -_B ● | black -12 ● |
| natural -_N ● | brutal -85 ● |
| burgundy -_U ● | burgundy -86 ● |
| terracotta -_R ● | terracotta -83 ● |
| sandy -_D ● | sandy -87 ● |
| taupe -_T ● | taupe -82 ● |
| grey -_A ● | grey -84 ● |
| gold -_G ● | gold -19 ● |

The brutal (-85) color variant of the luminaires can only be ordered with neutral optics (_N)

main material
aluminium

accessory

honeycomb

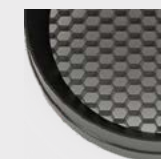

Not applicable to the GU10 version



Awarded products: PET LED mini | PET LED midi | PET LED maxi





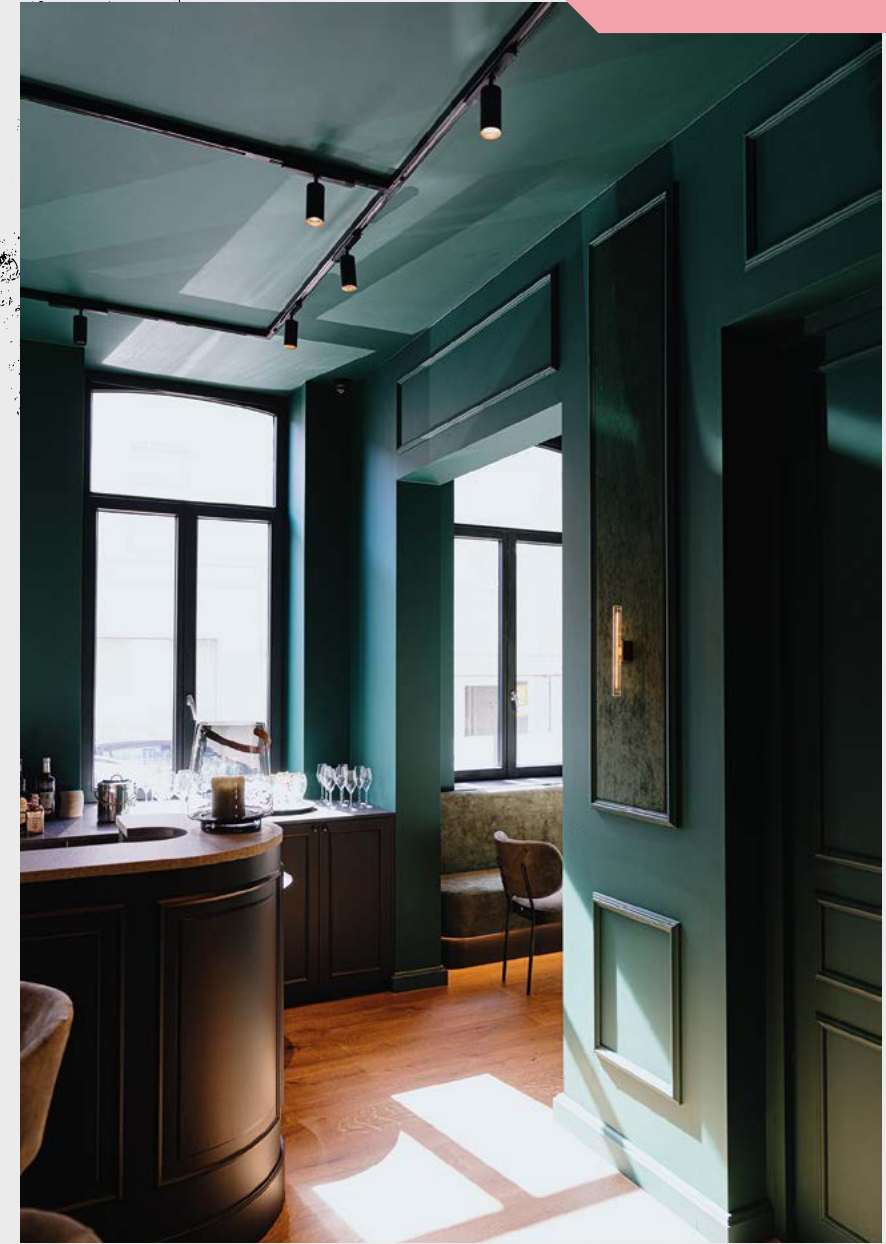

HYPER maxi zoom LED track | PUTT maxi move LED recessed

HYPER

HYPER zoom LED allows smooth adjustment of the beam angle within a 20-45° range using a rotating ring. The integrated LED and compact design support precise positioning and ensure a discreet presence within the interior.



recessed p. 094
surface p. 168
track

HYPER

PRECISION AND FLEXIBILITY

HYPER zoom LED track | multitrack | high multitrack

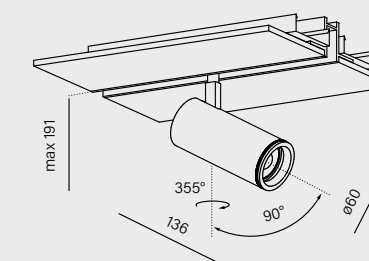
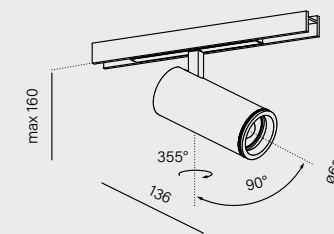
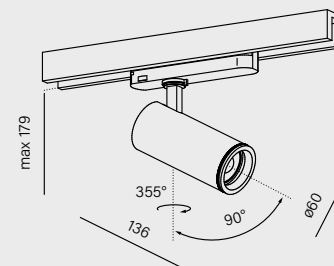

cat. n°	cat. n°	cat. n°
16446-M930-Z3-00-12	16450-M930-Z3-00-12	16449-M930-Z3-00-12
power:	9W (M)	
flux:	1027lm	
optics:	20° - 45° (Z_)	
CCT:	2700K (27) 3000K (30) 4000K (40)	
control:	ON/OFF (00) DALI (DA) Aqsmart (DB)	ON/OFF (00) ON/OFF second circuit (01) DALI (DA)

luminaire finishes

- white -13 ○
- black -12 ●
- burgundy -86 ●
- terracotta -83 ●
- sandy -87 ●
- taupe -82 ●
- grey -84 ●
- gold -19 ●

*not for HYPER zoom track

main material
aluminium



up: ALULINE mini LED multitrack
 down: PET midi LED high multitrack | RAFTER mini move LED high multitrack

ALULINE

ALULINE Multitrack is a linear luminaire available in two optical versions: with an opal diffuser providing even light or with points optics offering more focused task lighting. The version with an opal diffuser is well suited for use as uplight when installed in the upper track of the MULTITRACK up&down system. It delivers effective general illumination reflected from a light-coloured ceiling. The light distribution is highly uniform, with the luminaire itself remaining almost invisible.



NEW PRODUCT

ALULINE mini LED multitrack - | points

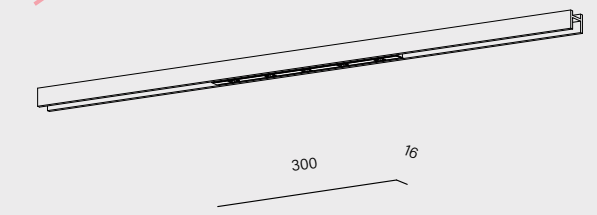
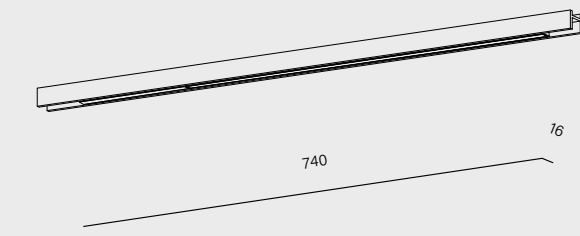

	cat. n°	cat. n°
	16516-M930-D9-00-70	16535-M930-WB-DA-12
power:	8W (M)	5W (M)
flux:	1070lm	440lm
optics:	opal (D9)	66° (W_)
CCT:	3000K (30) 4000K (40)	2700K (27) 3000K (30)
control:	ON/OFF (00) ON/OFF second circuit (01) DALI (DA)	DALI (DA)

- luminaire finishes** for ALULINE mini
 - alu anodized -70
 - black anodized -72
- optics finishes** ¹ for ALULINE mini points
 - white -_W
 - black -_B
- luminaire finishes** for ALULINE mini points
 - white -13
 - black -12

¹every color variant of the luminaires can only be ordered with its equivalent (e.g.-12 and -_B)

main material
aluminium | PC



recessed p. 104-114
 surface p. 206-212
 suspended p. 328-330
track
 wall p. 494
 systems p. 618



RAFTER mini LED
 move microtrack | multitrack | move multitrack | move high multitrack

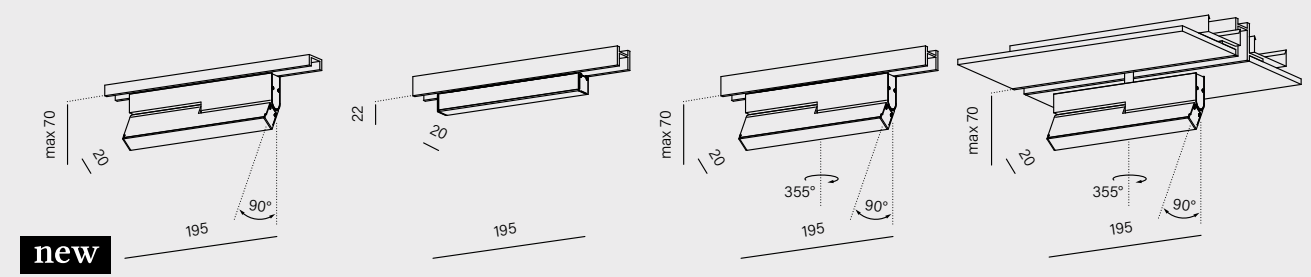

	cat. n°	cat. n°	cat. n°	cat. n°
	16517-M930-D9-00-12	16461-M930-D9-00-12	16466-M930-D9-00-12	16463-M930-D9-00-12
power:	12.5W (M)			
flux:	1670lm			
CCT:	2700K (27) 3000K (30)			
control:	ON/OFF (00) DALI (DA)		ON/OFF (00) ON/OFF second circuit (01) DALI (DA)	

RAFTER mini

A slim linear luminaire that provides general lighting while remaining a discreet element of the composition. The tiltable version allows light to be directed towards selected interior elements such as a wall, countertop or display.

luminaire finishes

- white -13 ○
- black -12 ●
- burgundy -86 ●
- terracotta -83 ●
- sandy -87 ●
- taupe -82 ●
- grey -84 ●
- gold -19 ●

main material
 aluminium | PC

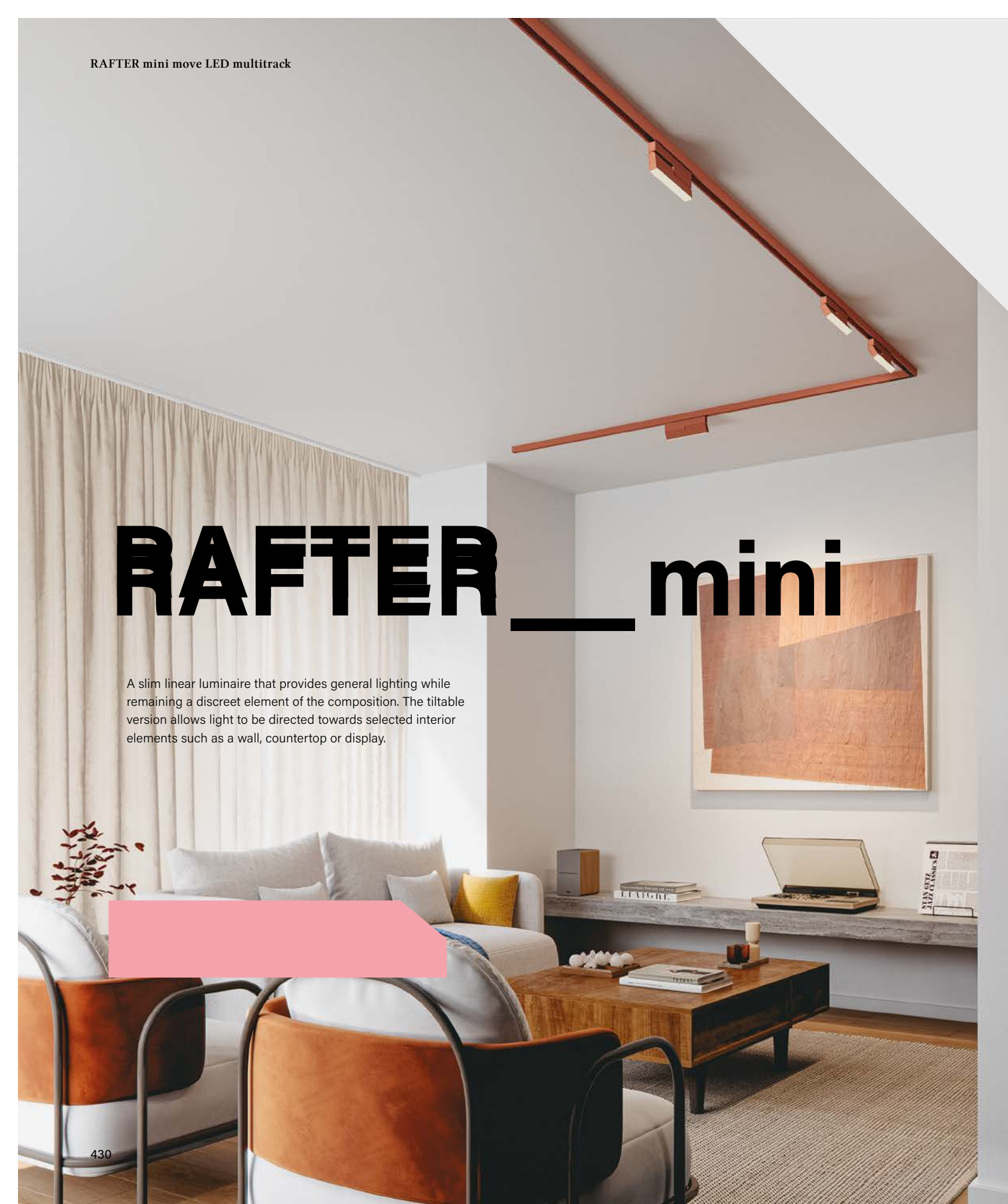

recessed p. 104-114
 surface p. 206-212
 suspended p. 328-330
track
 wall p. 494
 systems p. 618



RAFTER mini points LED
 multitrack | move multitrack | move high multitrack

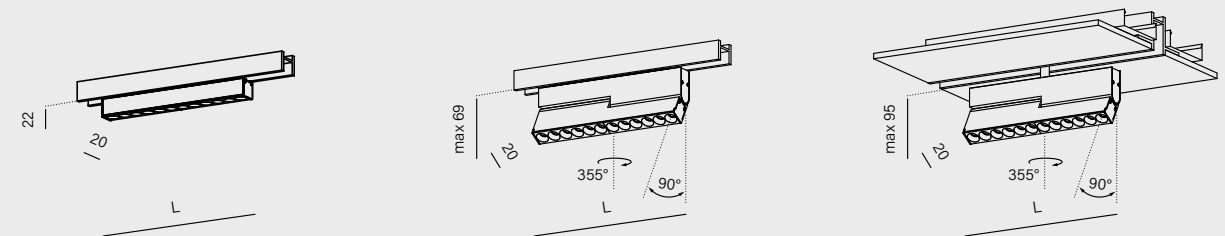

length	cat. n°	cat. n°	cat. n°
100mm	16457-M930-FB-00-12	16455-M930-FB-00-12	16452-M930-FB-00-12
195mm	16458-M930-FB-00-12	16456-M930-FB-00-12	16453-M930-FB-00-12
power:	4.5W - 9W (M)		
flux:	586lm - 1143lm		
optics:	24° (F_) 45° (W_)		
CCT:	2700K (27) 3000K (30)		
control:	ON/OFF (00) ON/OFF second circuit (01) DALI (DA)		

>90 CRI icon"/>

- optics finishes**
- white -_W
 - black -_B
- luminaire finishes**
- white -13
 - black -12
 - burgundy -86
 - terracotta -83
 - sandy -87
 - taupe -82
 - grey -84
 - gold -19
- main material**
 aluminium | PC



RAFTER mini points LED
 microtrack | move microtrack

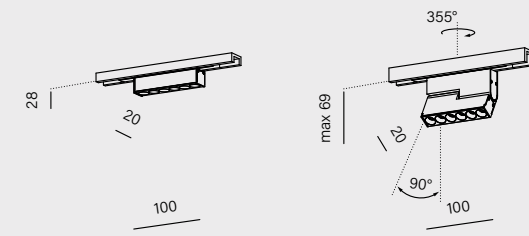

length	cat. n°	cat. n°
100mm	16451-M930-FB-00-12	16454-M930-FB-00-12
195mm		16518-M930-FB-00-12
power:	4.5W (M)	
flux:	586lm	
optics:	24° (F_) 45° (W_)	
CCT:	2700K (27) 3000K (30)	
control:	ON/OFF (00) DALI (DA)	

>90 CRI icon"/>

RAFTER

mini



PRECISE DIRECTIONAL MODULES

A CLEAR RHYTHM AND CONTROLLED LIGHTING

RAFTER mini points LED directs light precisely where it is required, onto work surfaces or architectural details. Deeply recessed light sources improve visual ease, while the linear composition with light points maintains visual clarity. This solution is scalable, from a single section to extended sequences.

RAFTER



RAFTER LED with an opal diffuser emits soft, pleasant light, making it suitable for general lighting in hotels or retail spaces. Its slim profile supports the creation of longer runs, ensuring a consistent and clearly structured lighting layout within the space.

Design: MONOstudio

recessed p. 104-114
 surface p. 206-212
 suspended p. 328-330
track
 wall p. 494
 systems p. 618



RAFTER LED track | multitrack | high multitrack

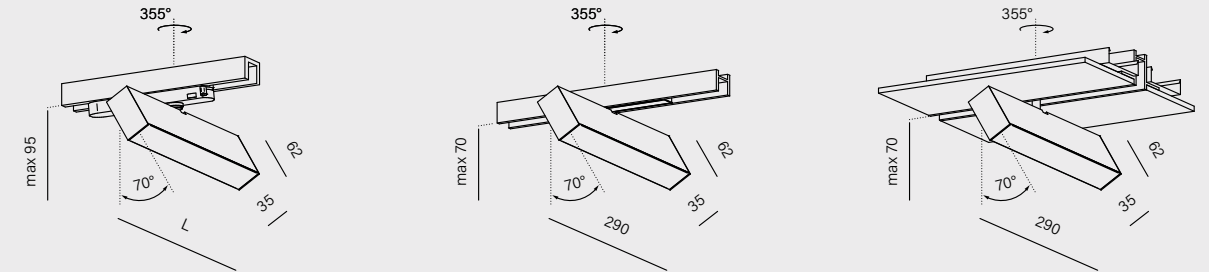

length	cat. n°	cat. n°	cat. n°
290mm	16335-M930-D9-00-12	16342-M930-D9-00-12	16441-M930-D9-00-12
430mm	16336-M930-D9-00-12		
power:	12.5W - 18.5W (M)		12.5W (M)
flux:	1552lm - 2328lm		1552lm
CCT:	2700K (27) 3000K (30) 4000K (40)		
control:	ON/OFF (00) DALI (DA) Aqsmart (DB)		ON/OFF (00) ON/OFF second circuit (01) DALI (DA)

luminaire finishes

- white -13
- black -12
- burgundy -86
- terracotta -83
- sandy -87
- taupe -82
- grey -84
- gold -19

*not for RAFTER track

main material

aluminium | PMMA



RAFTER points

RAFTER points LED is a versatile luminaire designed for lighting offices, retail spaces and service areas. Thanks to refined optics and carefully selected light output, it provides uniform and efficient illumination of work surfaces, combining precision craftsmanship with functional performance.



Design: DOMagała Design | Photo: Tom Kurek



RAFTER points LED track

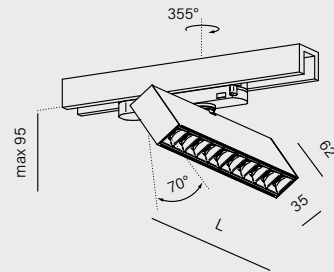

length	cat. n°
271mm	16323-M930-WB-00-12
404mm	16326-M930-WB-00-12
power:	10W - 15W (L) 20.5W - 31W (M)
flux:	1204lm - 3024lm
optics:	37° (F_) 50° (W_)
CCT:	2700K (27) 3000K (30) 4000K (40)
control:	ON/OFF (00) DALI (DA) Aqsmart (DB)



RAFTER points LED microtrack | multitrack | high multitrack

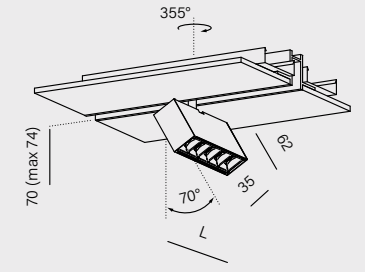
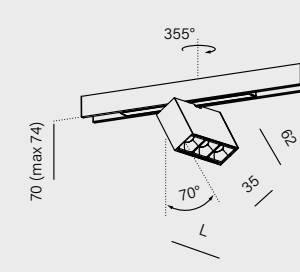
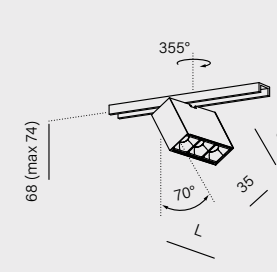

length	cat. n°	cat. n°	cat. n°
93mm	16422-M930-WB-00-12	16419-M930-WB-00-12	16421-M930-WB-00-12
138mm	16519-M930-WB-00-12	16341-M930-WB-00-12	16442-M930-WB-00-12
power:	3W (M)	3W - 5W (M)	
flux:	366lm	366lm - 602lm	
optics:	37° (F_) 50° (W_)		
CCT:	2700K (27) 3000K (30) 4000K (40)		
control:	ON/OFF (00) DALI (DA)	ON/OFF (00) ON/OFF second circuit (01) DALI (DA)	



- optics finishes**
- white -_W ○
- black -_B ●
- luminaire finishes**
- white -13 ○
- black -12 ●
- burgundy -86 ●
- terracotta -83 ●
- sandy -87 ●
- taupe -82 ●
- grey -84 ●
- gold -19 ●

*not for RAFTER points track

main material
aluminium | PC





SET TRU

SET TRU mini LED draws a clean line of light above countertops, tables and circulation areas. Its slim profile and selectable lengths make it easier to adapt the luminaire to the proportions and function of the interior.

Design: IN-ARCHITEKTURA I WNĘTRZA

recessed p. 122
 surface p. 224
 suspended p. 338
track
 wall p. 498
 systems p. 614

SET TRU

PRECISION AND FLEXIBILITY



SET TRU mini LED multitrack | points multitrack

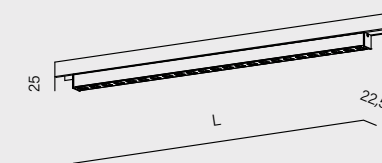
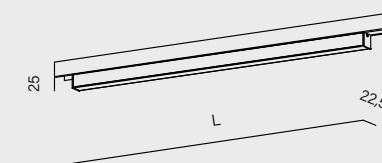

length	cat. n°	length	cat. n°
570mm	16374-M930-D9-00-12	285mm	16379-M930-WB-00-12
1140mm	16375-M930-D9-00-12	565mm	16380-M930-WB-00-12
		845mm	16381-M930-WB-00-12
power:	8W - 16W (M)		5W - 13W (M)
flux:	1070lm - 2140lm		717lm - 2085lm
optics:	opal (D9)		59° (W_)
CCT:	3000K (30) 4000K (40)		2700K (27) 3000K (30) 4000K (40)
control:	ON/OFF (00) ON/OFF second circuit (01) DALI (DA)		



optics finishes
 only for SET TRU mini points
 white -_W ○
 black -_B ●

luminaire finishes
 white -13 ○
 black -12 ●
 burgundy -86 ●
 terracotta -83 ●
 sandy -87 ●
 taupe -82 ●
 grey -84 ●
 gold -19 ●

main material
 aluminium | PMMA





TUBE flex LED high multitrack

TUBE

flex & stiff

TUBE flex and TUBE stiff are luminous tubes designed for track systems, suitable for general lighting while introducing a distinctive element to the interior. The flex version stands out thanks to its flexible construction and the ability to connect its ends to two independent tracks, opening up possibilities for bold, extended layouts and custom lighting compositions.



TUBE LED
stiff multitrack | flex multitrack | flex high multitrack

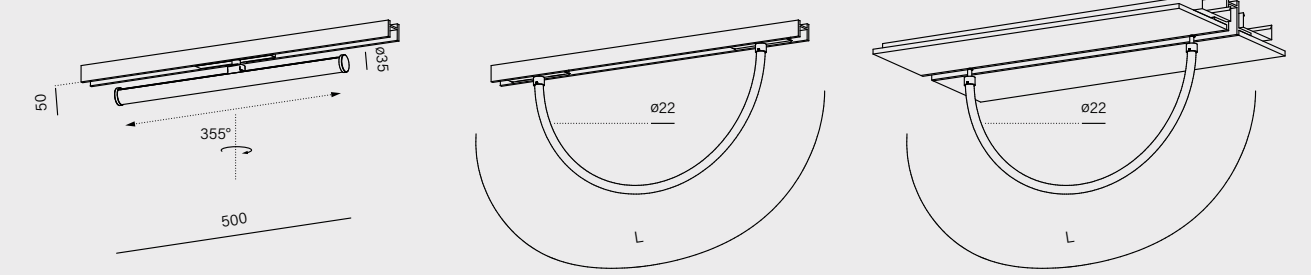

	cat. n°	length	cat. n°	length	cat. n°
	16514-M930-D9-00-12	1000mm	16510-M930-D9-00-12	1000mm	16512-M930-D9-00-12
		2000mm	16511-M930-D9-00-12	2000mm	16513-M930-D9-00-12
power:	10W (M)			10W - 20W (M)	
flux:	1290lm			1215lm - 2430lm	
CCT:			2700K (27) 3000K (30)		
control:			ON/OFF (00)		



luminaire finishes

- white -13 ○
- black -12 ●

main material

aluminium | silicone (flex) | PC (stiff)

BLOS round

BLOS round LED combines an aesthetically neutral form with high power durability and strong performance. Together with diffused emission, it works well as a source of general lighting.



BLOS round LED track | suspended track

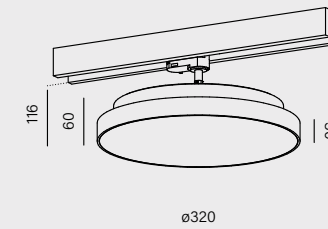

cat. n°

16423-M930-D9-00-12

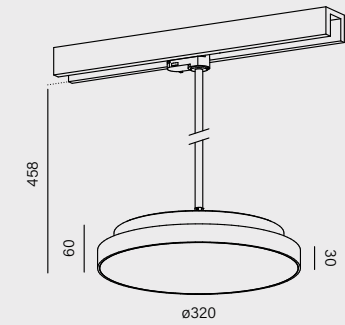

cat. n°

16424-M930-D9-00-12

power:	11.5W (L) 23W (M)
flux:	1725lm - 3268lm
CCT:	2700K (27) 3000K (30) 4000K (40)
control:	ON/OFF (00) DALI (DA) AQsmart (DB)



*the protection class depends on the luminaire control version

accessory

81300 - BLOS round PRO diffuser set



new



luminaire finishes

- white -13
- black -12
- burgundy -86
- terracotta -83
- sandy -87
- taupe -82
- grey -84
- gold -19

main material

PC | aluminium

MODERN BALL



MODERN BALL simple midi PW LED
track | suspended track

MODERN BALL simple mini PW LED
microtrack | suspended microtrack

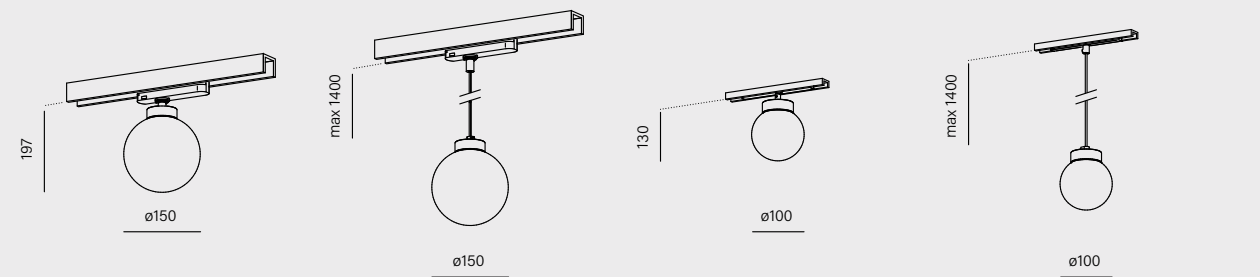

cat. n°	cat. n°	cat. n°	cat. n°
16386-M930-PW-00-12	16387-M930-PW-00-12	16430-M930-PW-00-12	16431-M930-PW-00-12
power:	6W (L) 9W (M)	4W (L) 6W (M)	
flux:	834lm - 1134lm	580lm - 794lm	
CCT:	2700K (27) 3000K (30) 4000K (40)		
control:	ON/OFF (00) DALI (DA)		

_simple



MODERN BALL simple midi PW LED
multitrack | suspended multitrack | high multitrack

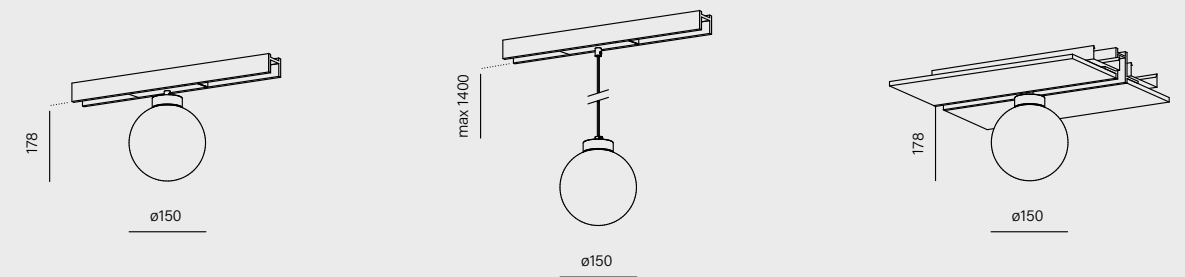

cat. n°	cat. n°	cat. n°
16388-M930-PW-00-12	16389-M930-PW-00-12	16429-M930-PW-00-12
power:	6W (L) 9W (M)	
flux:	834lm - 1134lm	
CCT:	2700K (27) 3000K (30) 4000K (40)	
control:	ON/OFF (00) ON/OFF second circuit (01) DALI (DA)	

surface p. 178-182
suspended p. 296-298
track
upright p. 514
systems p. 584

MODERN BALL

PRECISION AND FLEXIBILITY

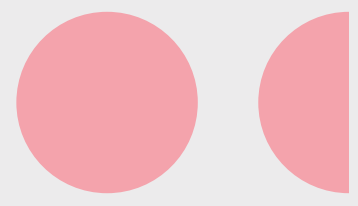

MODERN BALL simple combines the timeless form of a glass sphere with softly diffused light. It works well as a single piece and in groups above tables, counters or meeting areas.

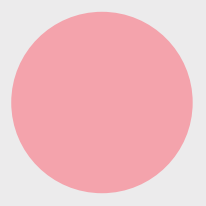

luminaire finishes

- white -13 ○
- black -12 ●
- burgundy -86 ●
- terracotta -83 ●
- sandy -87 ●
- taupe -82 ●
- grey -84 ●
- gold -19 ●

main material

aluminium | glass



Soft, diffused light provides general illumination and creates a welcoming atmosphere. In groups, it forms a harmonious composition, while as a single fixture it serves as a discreet yet recognizable decorative accent. Every detail of the luminaire has been carefully refined to balance form and light.

TIMELESS FORM
SOFT LIGHT
HARMONIOUS PROPORTIONS

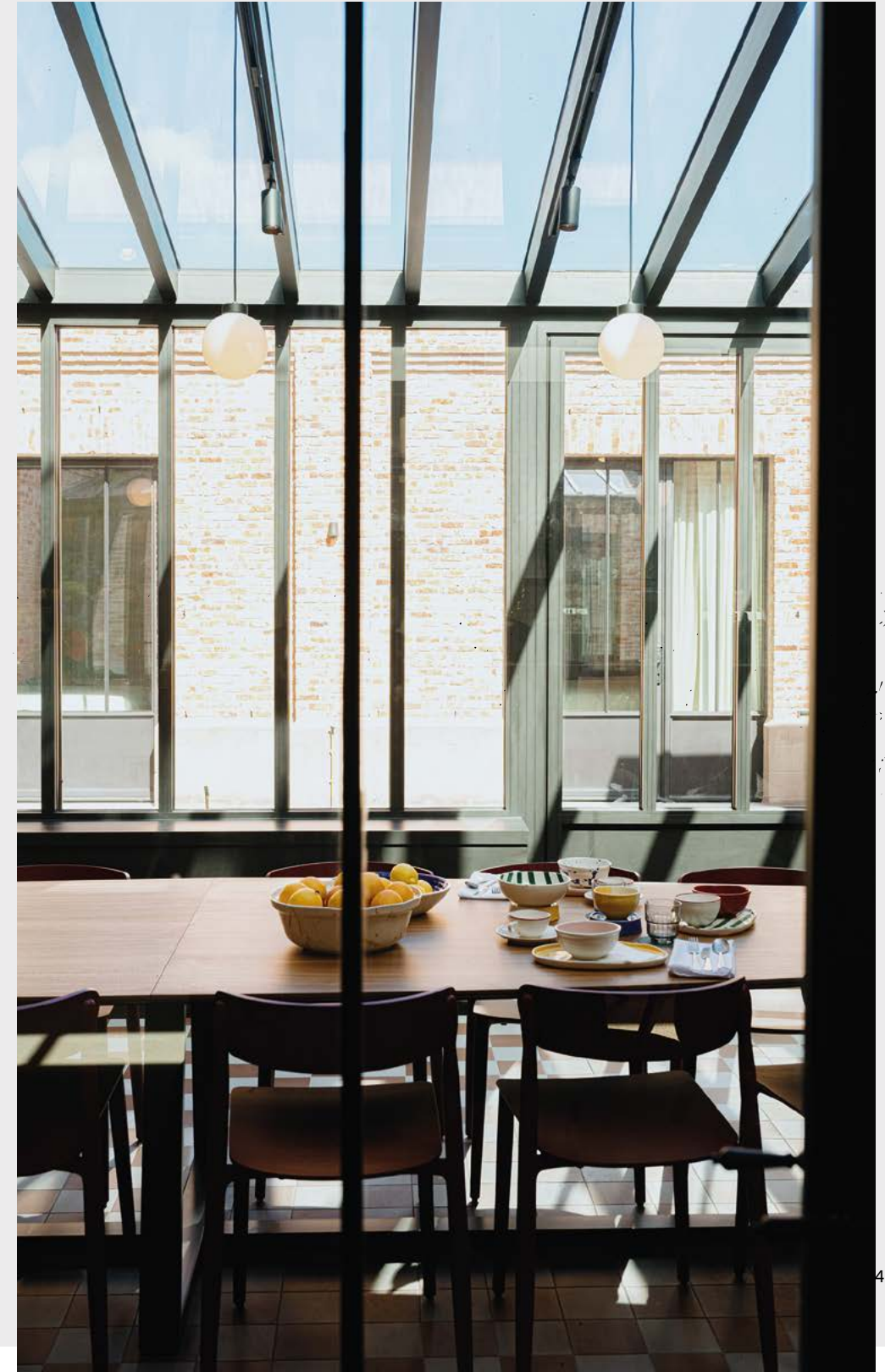

INTERIOR

WALL

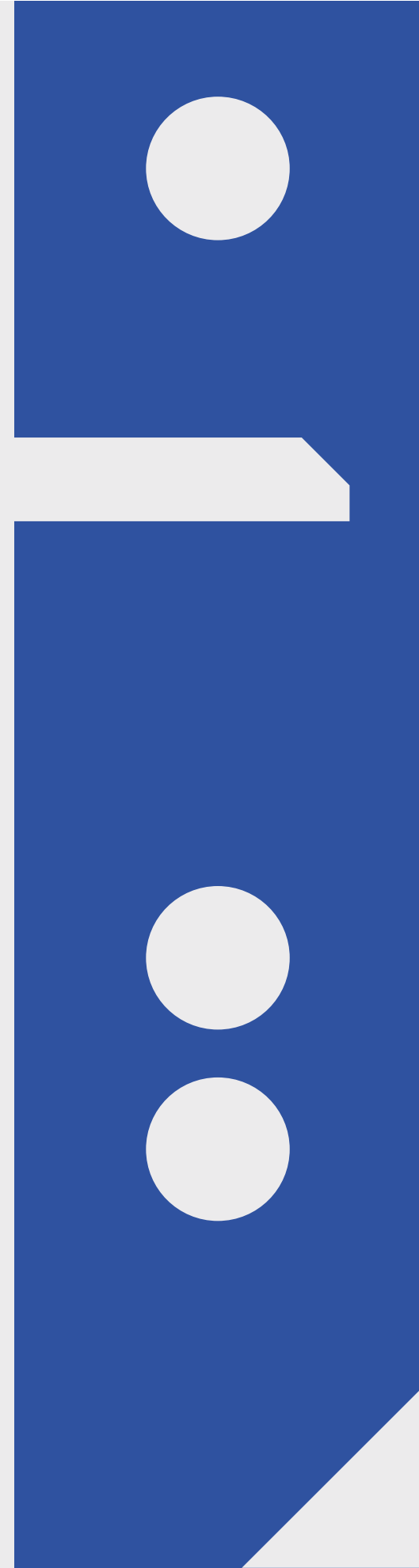
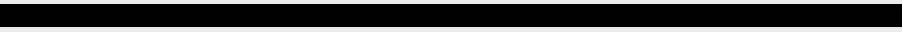

WALL
ILLUMINATION



INTERIOR WALL

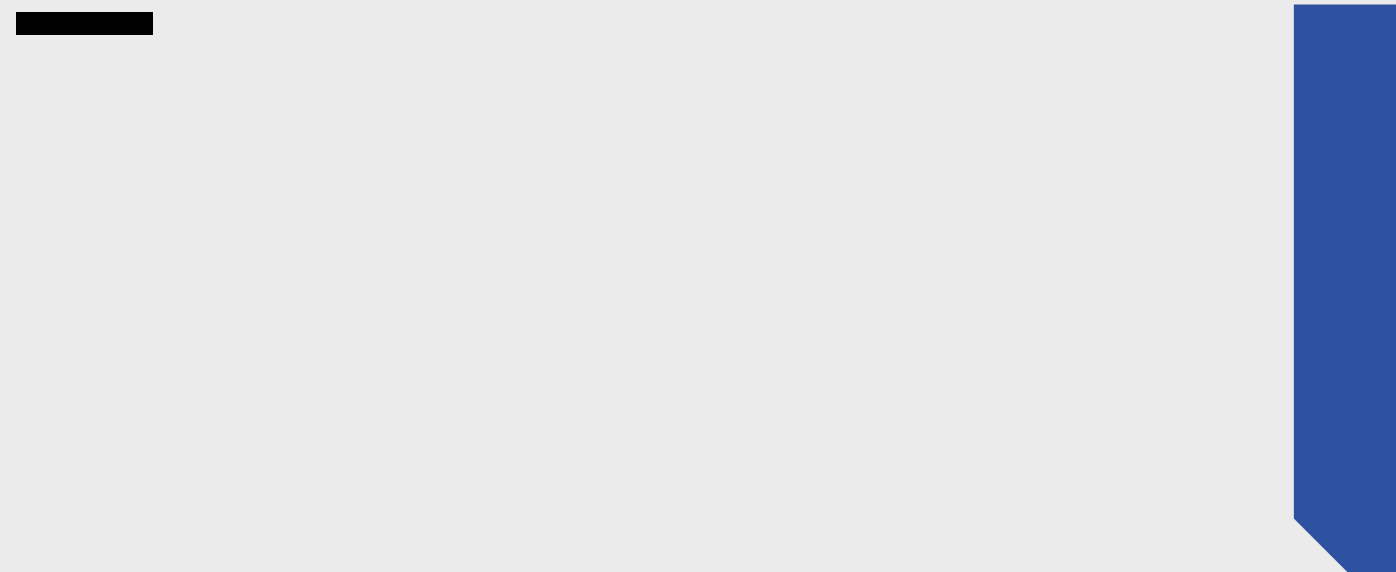

RECESSED
EMOT round



p. 460

EMOT square



p. 460

EMOT round
sensor



new

p. 460

EMOT square
sensor



new

p. 460

IKI round



p. 482

MAXI POINT round



p. 484

LUMINAIRES
RIBBY up&task



new

p. 466

RIBBY up



new

p. 466

RIBBY up&down



p. 466

TRIBA mini



p. 470

TRIBA mini up&down



p. 470

PET mini



p. 472

PET midi



p. 472

MODERN GLASS



p. 480

IKI round E27



p. 482

PIPER 230V



p. 486

PIPER move 230V



p. 486

SET RAW mini
move



p. 490

RAFTER



p. 494

SPOT
PET micro R



p. 474

PET micro R switch



p. 474

PET micro O



p. 474

PET micro O switch



p. 474

IP-RATED
MODERN GLASS



p. 480

SET RAW mini



p. 490

THIN TUBE twist



p. 492

SET TRU



p. 496

INTERIOR WALL

Wall fixtures organise the space and highlight the architecture. They illuminate corridors, staircases and entrance areas, creating a clear and structured lighting layout. Discreet light points, linear fixtures and glass forms can be found among the available solutions.

RIBBY up&down LED wall

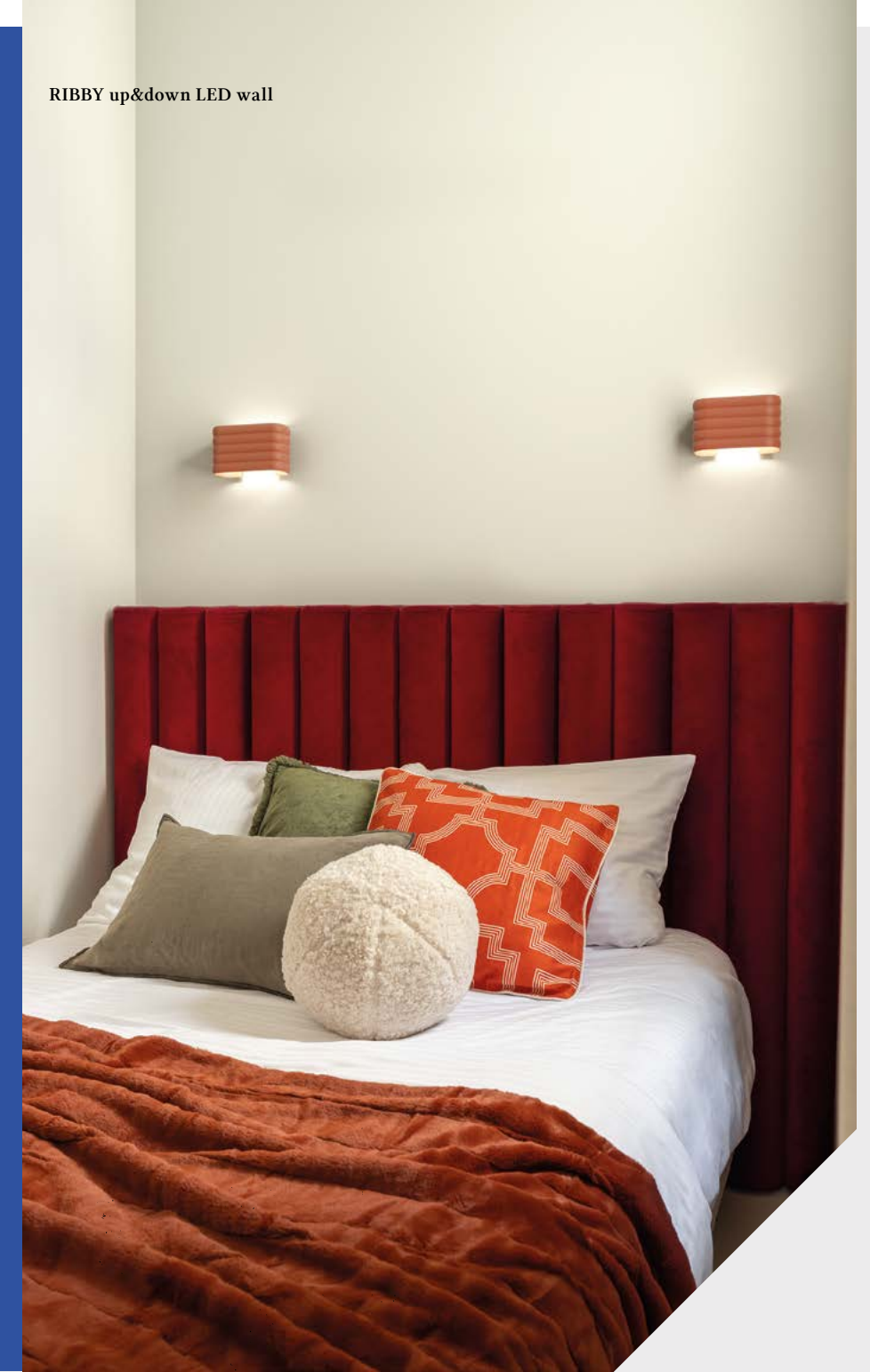



EMOT_



NEW PRODUCT



EMOT LED
round | square | round sensor | square sensor

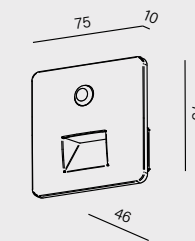
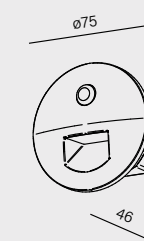
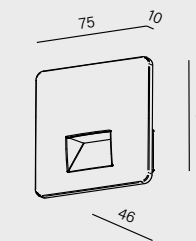

cat. n°	cat. n°	cat. n°	cat. n°
26589-M930-DA-00-12	26590-M930-DA-00-12	26592-M930-DA-MS-12	26593-M930-DA-MS-12
power: 4W (M)			
flux: 251lm			
CCT: 2700K (27) 3000K (30)			
control: ON/OFF (00)		Motion Sensor (MS)	



luminaire finishes

- white -13
- black -12
- brutal -85
- burgundy -86
- terracotta -83
- sandy -87
- taupe -82
- grey -84
- gold -19

main material
aluminium | PC



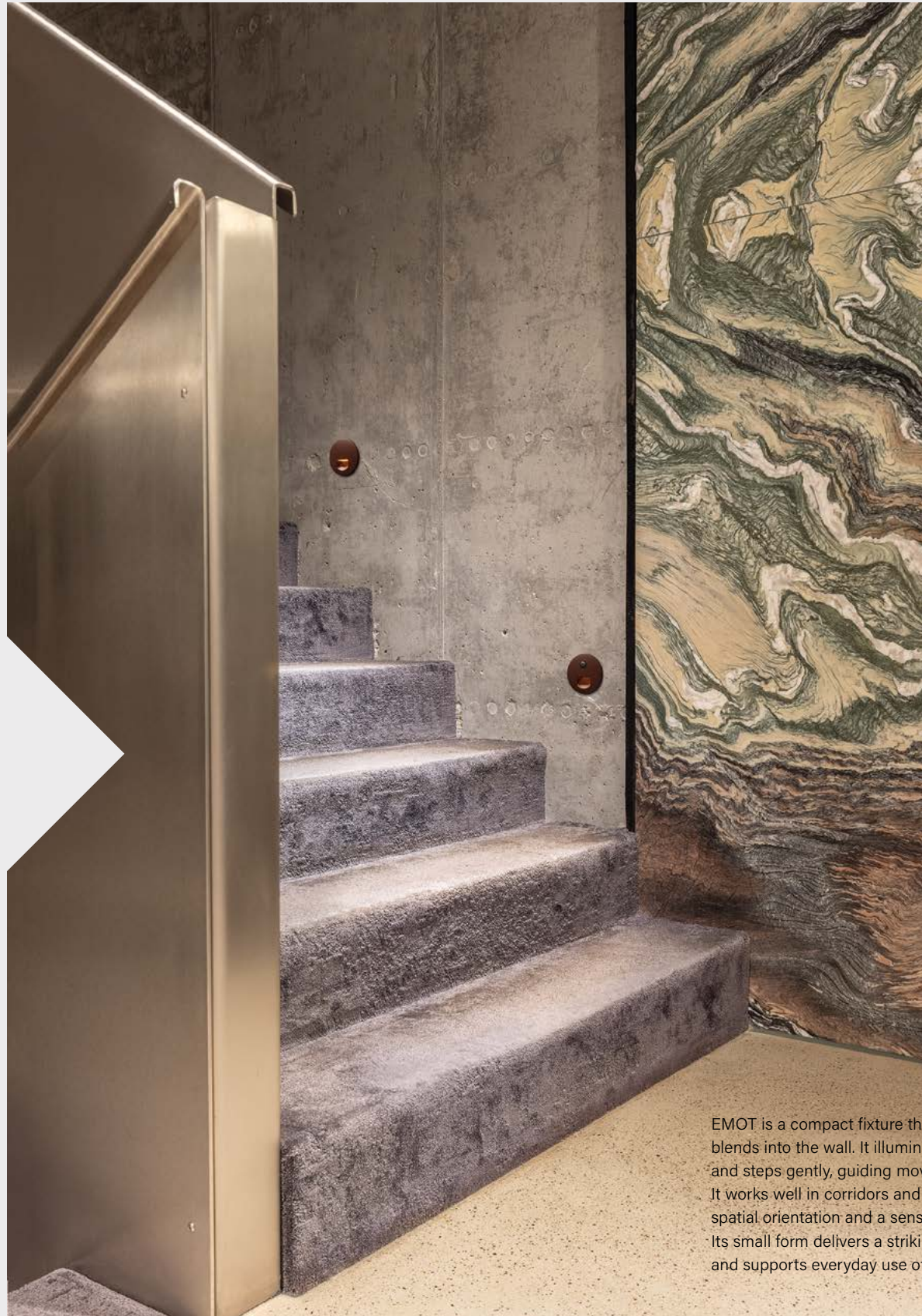

EMOT is a compact fixture that discreetly blends into the wall. It illuminates the floor and steps gently, guiding movement after dark. It works well in corridors and staircases, where spatial orientation and a sense of safety are key. Its small form delivers a striking visual effect and supports everyday use of the interior.

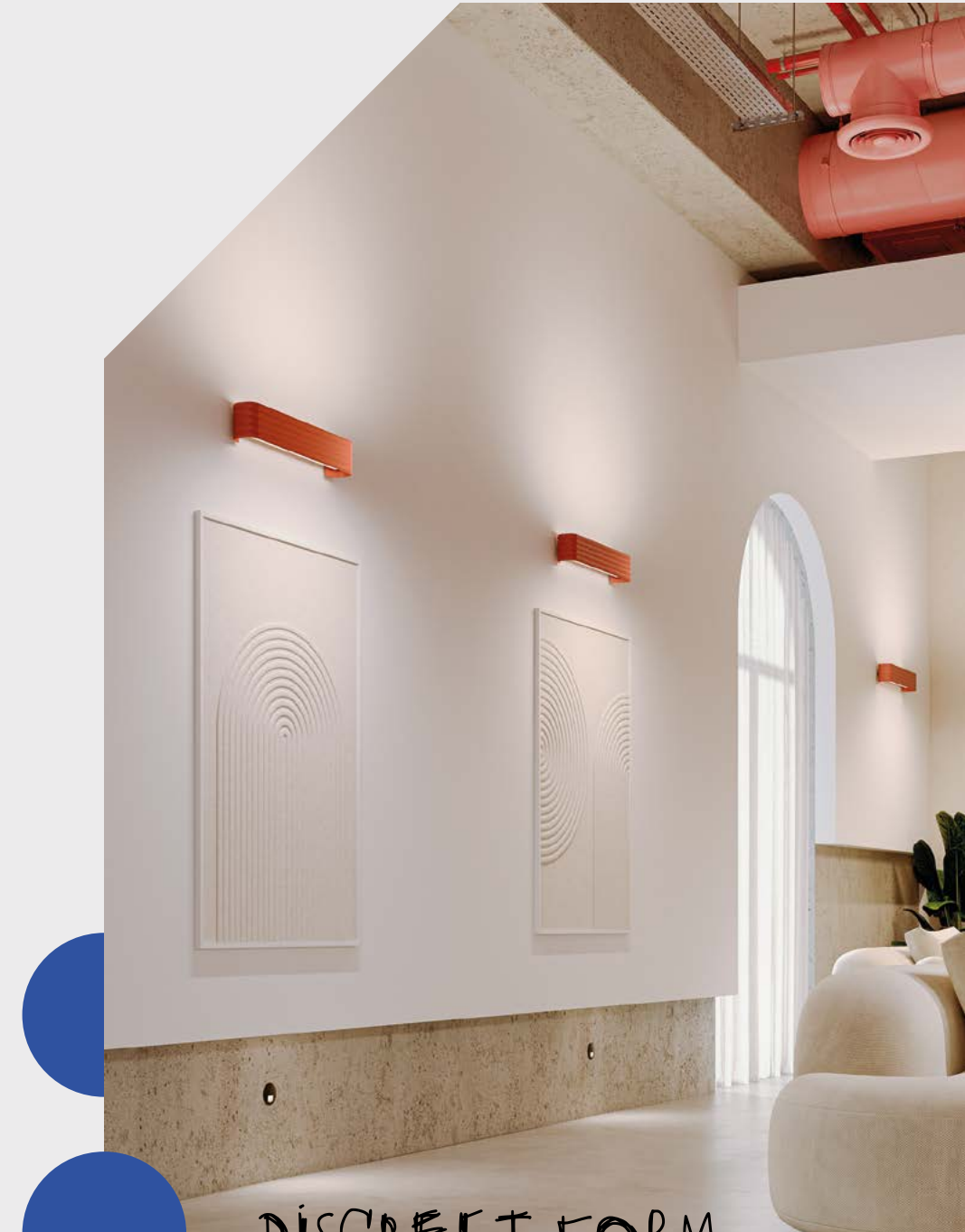

DISCREET FORM
CLEAR DIRECTION
SAFE MOVEMENT AFTER DARK

RIBBY wall

The RIBBY wall family has been expanded with the up version, which emits light exclusively upward, and the up&task version. The up&task variant combines light directed toward the wall and ceiling with a lower PET micro module designed for precise illumination of functional zones, such as by a bed or sofa. This solution works particularly well in hotel rooms and relaxation areas.

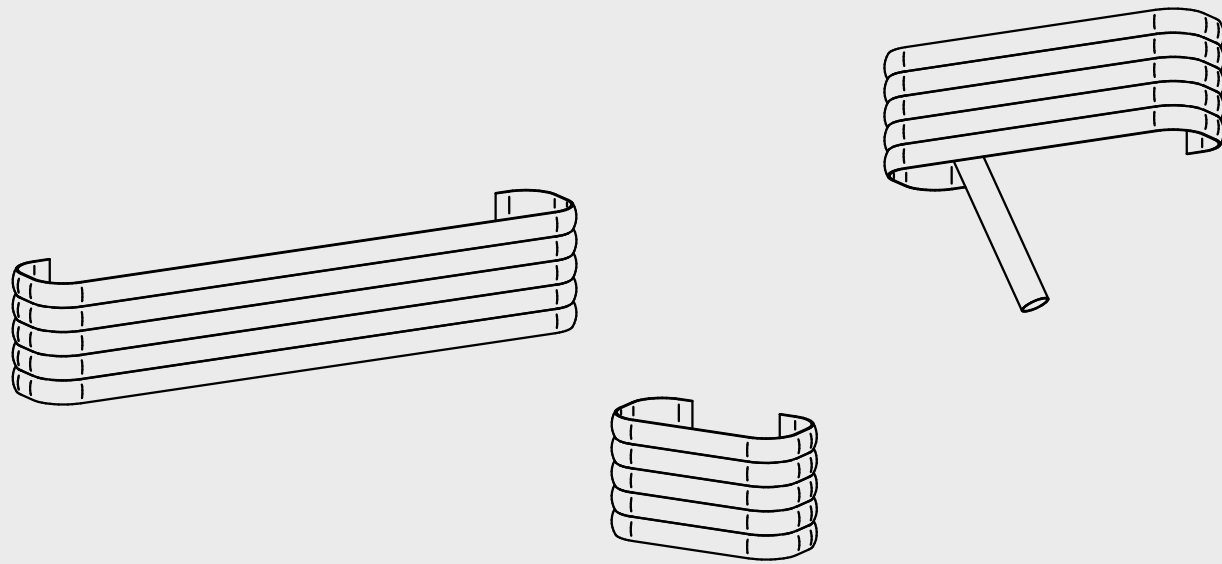

RIBBY up&task LED wall

RIBBY

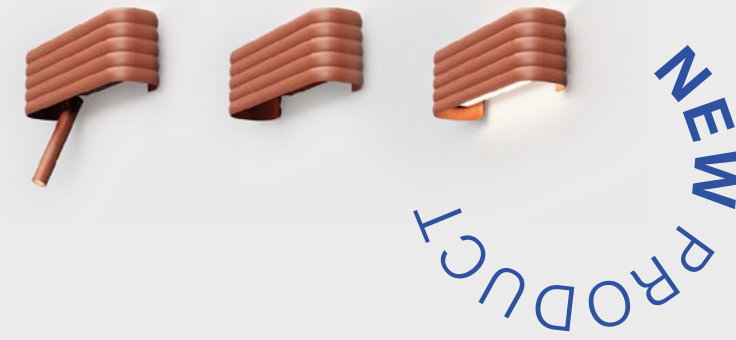

RIBBY LED
up&task | up | up&down

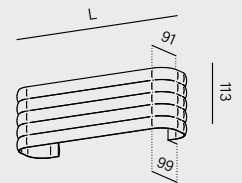
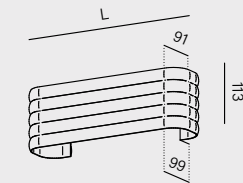
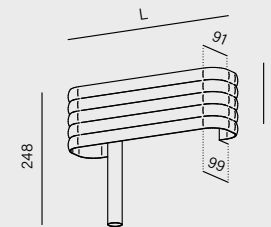

length	cat. n°	cat. n°	cat. n°
189mm	26599-M930-Y6-00-12	26596-M930-Y3-00-12	26586-M930-Y3-00-12
330mm	26600-M930-Y6-00-12	26597-M930-Y3-00-12	26587-M930-Y3-00-12
610mm	-	26598-M930-Y3-00-12	26588-M930-Y3-00-12
power:	4.5W - 7W (L) 6.5W - 11W (M) 8.5W - 15W (H)	2W - 8.5W (L) 4.5W - 17W (M) 6W - 25W (H)	4.5W - 17W (L) 8.5W - 42W (M) 12.5W - 50W (H)
flux:	514lm - 1775lm	291lm - 3104lm	582lm - 6208lm
CCT:	2700K (27) 3000K (30)		
control:	ON/OFF (00) switchDIM (SW) * DALI (DA) *		



*not apply to PET micro module



luminaire finishes

- white -13 ○
- black -12 ●
- burgundy -86 ●
- terracotta -83 ●
- sandy -87 ●
- taupe -82 ●
- grey -84 ●
- gold -19 ●

main material

aluminium | PMMA

RIBBY up&down LED wall

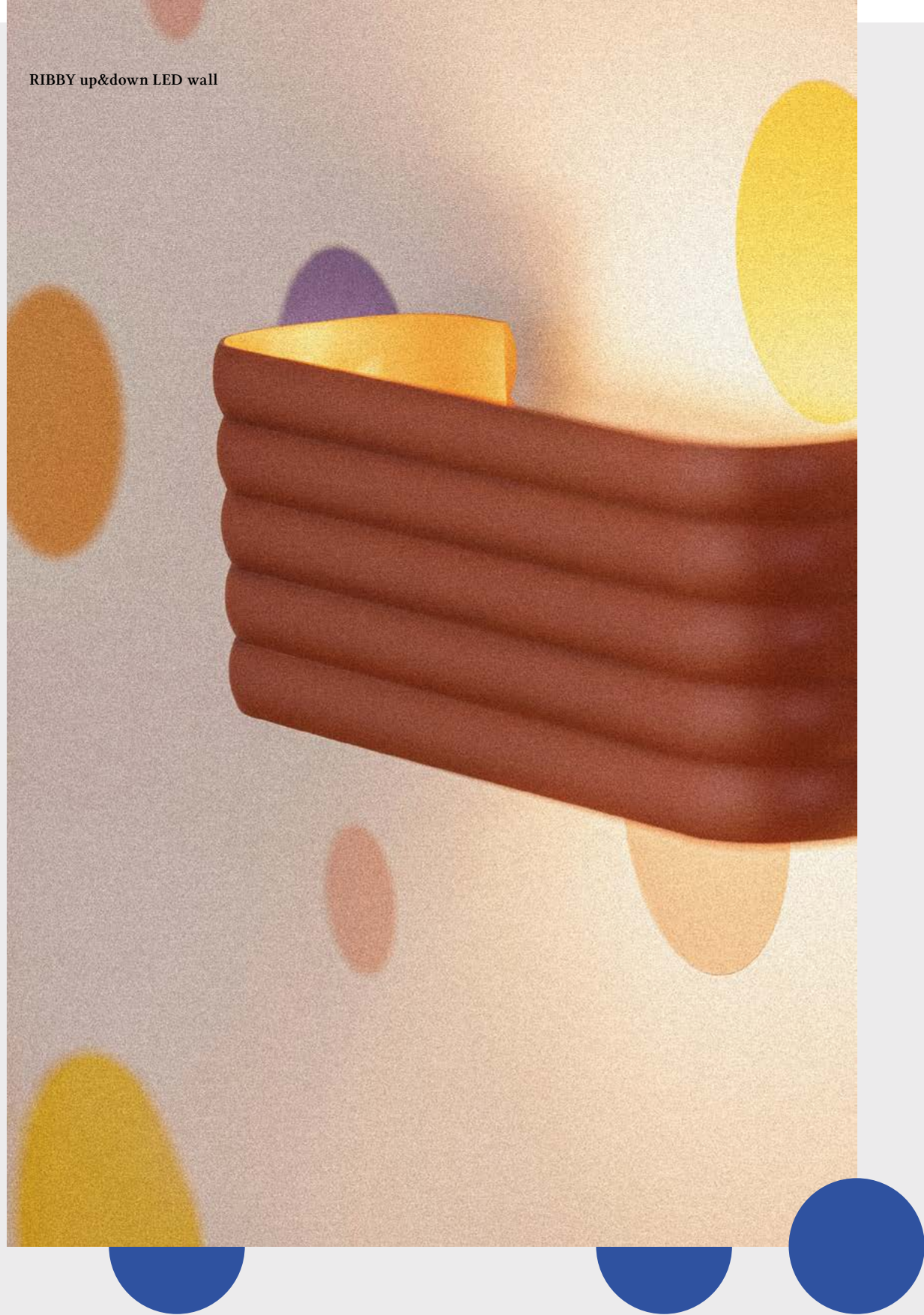

RIBBY up&down emits light both upward and downward. It effectively illuminates the ceiling and the floor, providing even, eye-friendly lighting throughout the interior, while also creating a distinct light pattern on the wall. This fixture works well in corridors, entrance areas and staircases, where both sufficient lighting and a decorative visual effect are important.

RIBBY up&down LED wall



TRIBA_

TRIBA mini is a compact wall fixture designed to accentuate selected sections of the wall. It comes in a downward or up-and-down lighting version. When arranged in a series, it creates a structured rhythm in corridors, near staircases and in rooms, subtly complementing the main lighting.



recessed p. 090
 surface p. 148-152
 suspended p. 282
 track p. 412-414
wall
 systems p. 584

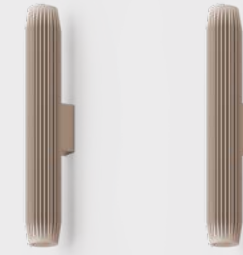

TRIBA mini LED - | up&down

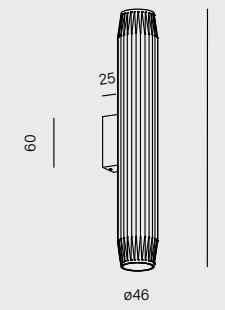

cat. n°

26566-M930-WT-00-82

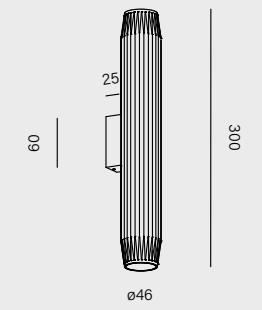

cat. n°

26567-M930-WT-00-82

power:	4.5W (M)	6W (M) 8.5W (H)
flux:	543lm	778lm - 1086lm
optics:	20° (S_) 41° (W_)	
CCT:	2700K (27) 3000K (30) 4000K (40)	
control:	ON/OFF (00)	



accessory

honeycomb



ring finishes

- white -_W ○
- black -_B ●
- natural -_N ●
- burgundy -_U ●
- terracotta -_R ●
- sandy -_D ●
- taupe -_T ●
- grey -_A ●
- gold -_G ●

luminaire finishes

- white -13 ○
- black -12 ●
- brutal -85 ●
- burgundy -86 ●
- terracotta -83 ●
- sandy -87 ●
- taupe -82 ●
- grey -84 ●
- gold -19 ●

The brutal (-85) color variant of the luminaires can only be ordered with neutral optics (_N)

main material
 aluminium

PET

PET fixtures stand out with their simple, cylindrical form that easily fits into various interior styles. Depending on the version, they can serve different functions. The cohesive design of the entire product family makes it easy to create consistent lighting arrangements in apartments, hotels and shared spaces.

237

recessed p. 092
 surface p. 162-164
 suspended p. 304-306
 track p. 416-420
wall
 exterior p. 538
 systems p. 584



PET LED mini | midi

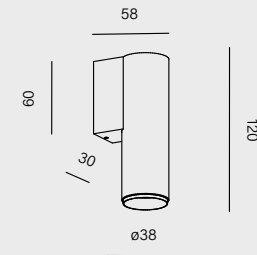

cat. n°

26510-M930-WB-00-12

power:

4.5W (M)

flux:

543lm

optics:

20° (S_) | 41° (W_)

CCT:

2700K (27) | 3000K (30) | 4000K (40)

control:

ON/OFF (00)

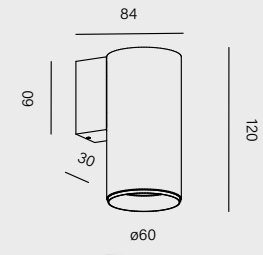

cat. n°

26509-M930-WB-00-12

power:

8.5W (M)

flux:

1149lm

optics:

18° (S_) | 35° (F_) | 50° (W_)

CCT:

2700K (27) | 3000K (30) | 4000K (40)

control:

ON/OFF (00) | Phase-Control (PH)



accessory

honeycomb



ring finishes

- white -_W ○
- black -_B ●
- natural -_N ●
- burgundy -_U ●
- terracotta -_R ●
- sandy -_D ●
- taupe -_T ●
- grey -_A ●
- gold -_G ●

luminaire finishes

- white -13 ○
- black -12 ●
- brutal -85 ●
- burgundy -86 ●
- terracotta -83 ●
- sandy -87 ●
- taupe -82 ●
- grey -84 ●
- gold -19 ●

The brutal (-85) color variant of the luminaires can only be ordered with neutral optics (_N)

main material

aluminium

PET micro



PET micro R LED - | USB¹

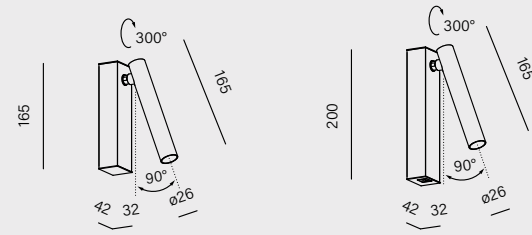

cat. n°	cat. n°
26504-M930-F3-00-12	26531-M930-F3-00-12
power:	2.5W (M)
flux:	223lm
optics:	32° (F ₋)
CCT:	2700K (27) 3000K (30) 4000K (40)
control:	ON/OFF (00)

¹This luminaire model is available with an integrated USB-C socket.

PET micro R switch LED - | USB¹

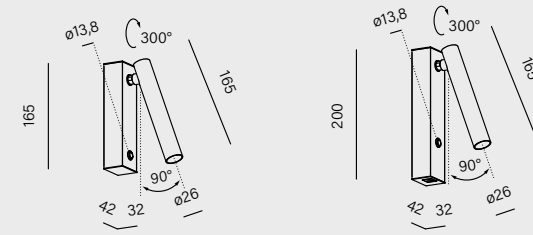

cat. n°	cat. n°	cat. n°	cat. n°
26508-M930-F3-00-12	26530-M930-F3-00-12	26527-M930-F3-00-12	26526-M930-F3-00-12
power:	2.5W (M)		
flux:	223lm		
optics:	32° (F ₋)		
CCT:	2700K (27) 3000K (30) 4000K (40)		
control:	ON/OFF (00)		

¹This luminaire model is available with an integrated USB-C socket.

switch detail

black switch



chrome switch



Black luminaires have a black switch.
For all other finishes of luminaires, the switch is in chrome finish.



luminaire finishes

- white -13
- black -12
- burgundy -86
- terracotta -83
- sandy -87
- taupe -82
- grey -84
- gold -19

main material

aluminium

PET micro is the smallest fixture in the family, discreet in form and precise in function. Its focused light highlights a shelf or a section of the wall and works perfectly as a reading light in bedrooms or lounge areas. Its compact size and simple shape allow it to blend seamlessly into any space.

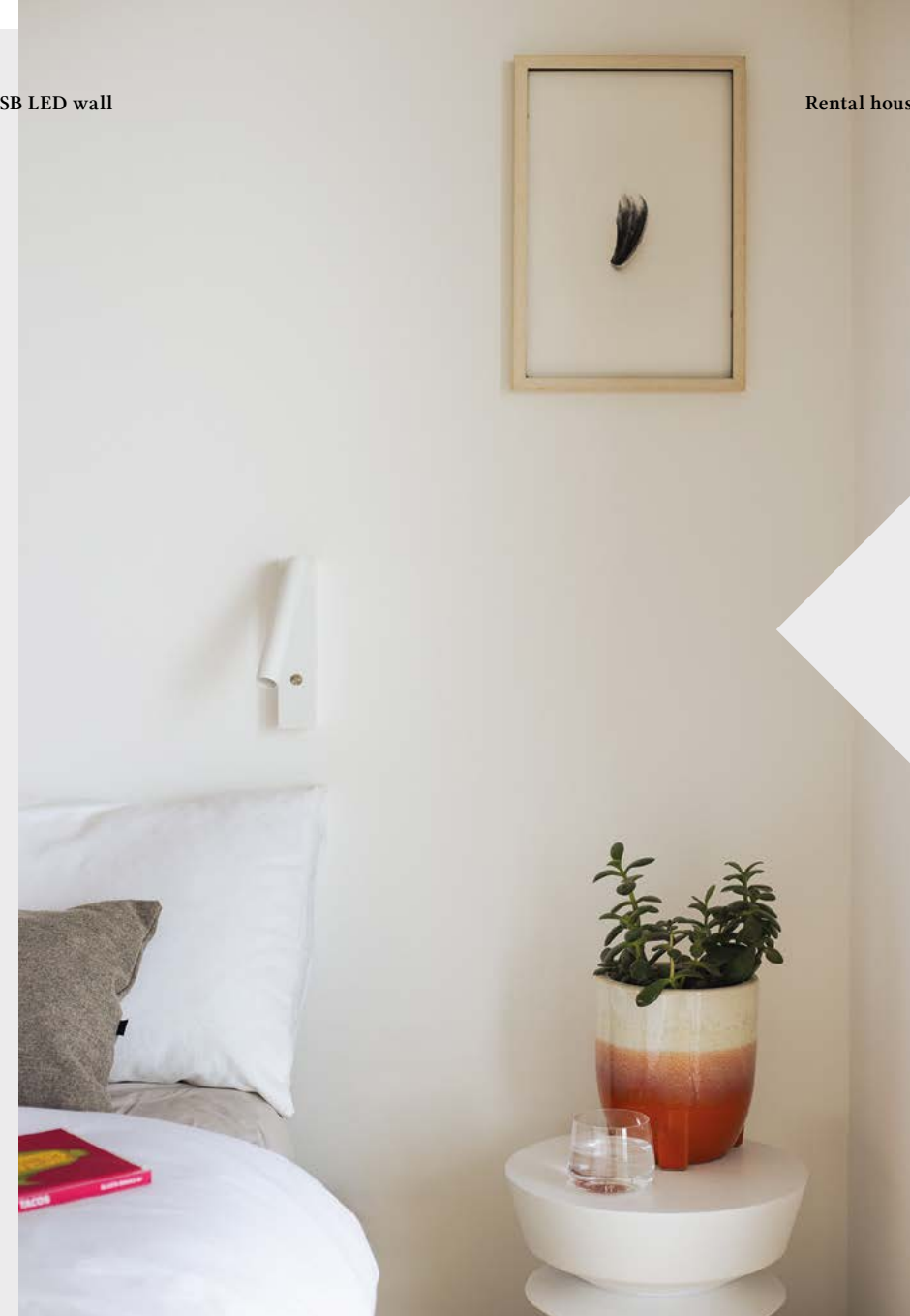

COMPACT
WALL FIXTURE

DISCREET
LIGHT ACCENT



PET micro O LED wall

Modern house with character, Zielona Góra



PET micro R switch USB LED wall

Six-person family home, Stara Kuźnia k/Opola



MODERN GLASS



MODERN GLASS Tube combines a simple cylindrical form with soft light diffused through a glass shade. The fixture pairs well with various materials, such as wood, concrete or fabric. It works perfectly in hallways, corridors and bedrooms, introducing a characterful, decorative lighting effect.



MODERN GLASS Tube LED - | hermetic

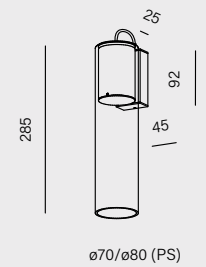

ø70/ø80 (PS)

cat. n°

26591-M930-PP-00-12

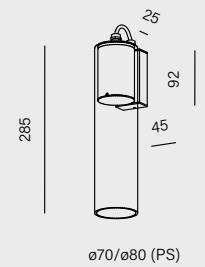

ø70/ø80 (PS)

cat. n°

26607-M930-PP-00-12

power:	8.5W (M)
flux:	1149lm
optics:	Plain Transparent (PP) Plain Karo (PK) Plain Strip (PS) Plain White (PW)
CCT:	2700K (27) 3000K (30) 4000K (40)
control:	ON/OFF (00) Phase-Control (PH)

glass finishes

PP



PK



PS



PW



luminaire finishes

- white -13
- black -12
- burgundy -86
- terracotta -83
- sandy -87
- taupe -82
- grey -84
- gold -19

main material

aluminium | glass

IKI_

IKI is a wall fixture that creates a decorative effect on the wall. The LED version offers a gentle glow that shines through the openwork front. The E27 version provides a subtle light accent, with the openwork element serving as a visual backdrop. The simple form of both versions pairs easily with various materials, seamlessly complementing other elements of the interior.

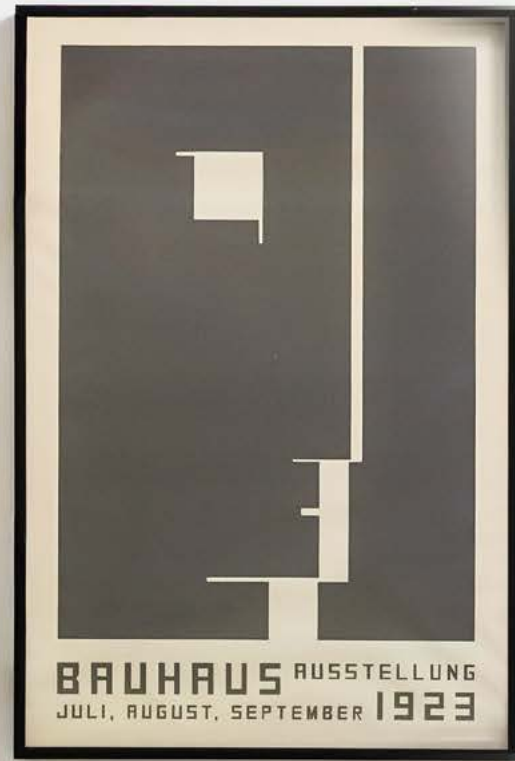

IKI round LED

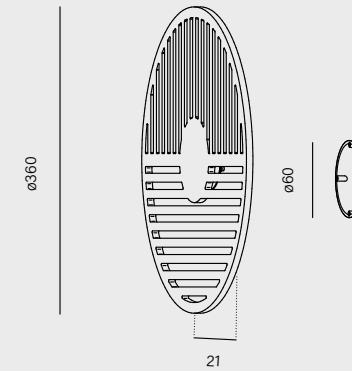

cat. n°

26563-M930-D9-00-G2

power:	4.5W (M)
flux:	543lm
CCT:	2700K (27) 3000K (30) 4000K (40)
control:	ON/OFF (00)



IKI round E27

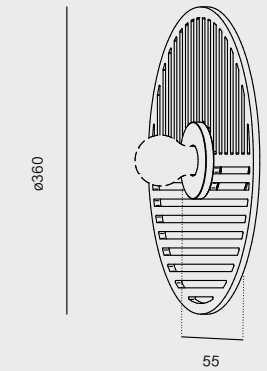

cat. n°

26561-E000-00-PH-G2

power:	max: 15W
control:	Phase-Control (PH)



light source not included

black&graphite panel -G2 black&ash panel -A2 black&orange panel -O2

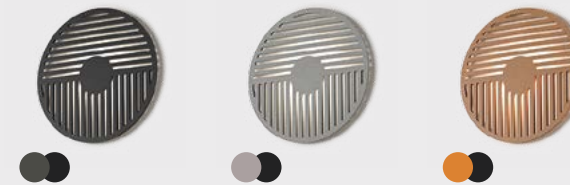

luminaire finishes

- black&graphite panel -G2
- black&ash panel -A2
- black&orange panel -O2

main material

MDF | aluminium | steel (LED) | PMMA (LED)



MAXI point

MAXI POINT light highlights a section of the wall with a simple, clear effect. It subtly brightens the surroundings and adds character to the interior. It works well in corridors, entrance areas and outdoor spaces where it serves as discreet façade lighting.

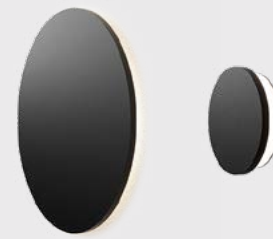

MAXI POINT round LED - | SR

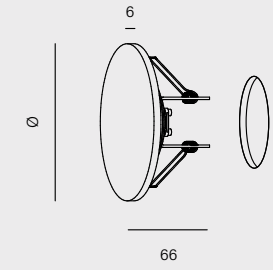
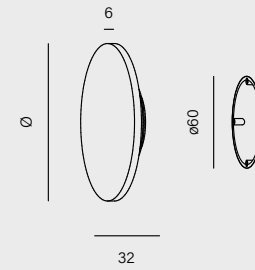

∅ 55mm | Hmin: 55mm

diameter	cat. n°	cat. n°
80mm	26535-M930-D9-00-12	26534-M930-D9-00-12
128mm	26514-M930-D9-00-12	26512-M930-D9-00-12
210mm	26609-M930-D9-00-12	26602-M930-D9-00-12
power:	4.5W (M) 4.5W (A)	
flux:	543lm (M) 540lm (A)	
CCT:	2700K (27) 3000K (30) 4000K (40)	
CC driver:	(B) 500mA 8.6V	
control:	ON/OFF (00) require driver (CC)*	



* Protection class, input voltage and IP rating for CC luminaires vary from above table.

MAXI POINT led spider wall

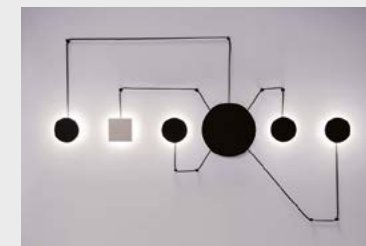

Do you need a non standard solution? Check out the system spider version, where you can join a few luminaires.

More info on our website and at page 584.



luminaire finishes

- white -13
- black -12
- burgundy -86
- terracotta -83
- sandy -87
- taupe -82
- grey -84
- gold -19

main material

aluminium | PMMA | steel

PIPER

PIPER is a luminous tube that emits soft, diffused light. It can serve as a striking interior element while also functioning as the main source of illumination. The move version allows the body to be positioned across wide range of angles relative to the wall, offering additional design flexibility.



PIPER LED 230V - | move

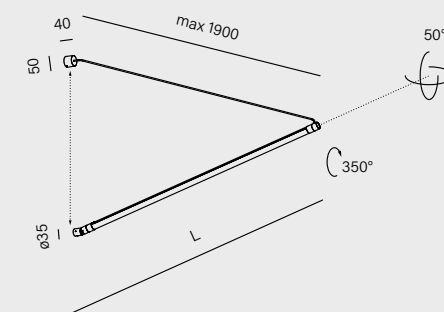
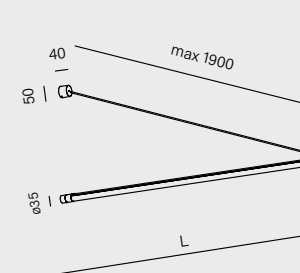

length	cat. n°	length	cat. n°
1320mm	26582-M942-D9-PH-12	1365mm	26584-M942-D9-PH-12
1540mm	26583-M942-D9-PH-12	1585mm	26585-M942-D9-PH-12
power:		23.5W - 26.5W (M)	
flux:		2970lm - 3077lm	
CCT:		adjustable: 2700K, 3000K, 4000K (42)*	
control:		Phase-Control (PH)	



*Possibility to change the colour temperature using integrated switch.



luminaire finishes
black -12 ●

main material
aluminium | PC



A slim cylinder emitting diffused light across nearly its entire surface. Also available in the move version, it allows the body to be **angled in various directions**, adding flexibility to lighting composition and interior character.



SET RAW

SET RAW mini creates a narrow line of light on the wall. Its opal diffuser provides soft, diffused illumination. The hermetic version is suitable for moisture-prone areas and works well as lighting above a bathroom mirror. The move version, with a light line positioned further from the wall and adjustable beam direction, is a great solution for illuminating artwork or larger wall sections.



recessed p. 120
suspended p. 320
wall
systems p. 610



SET RAW mini LED move | hermetic

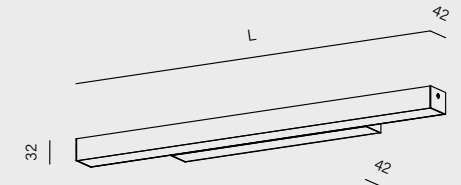
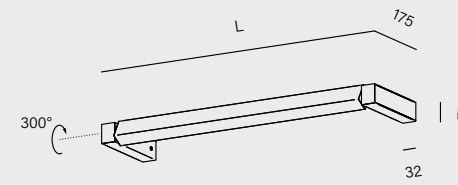

length	cat. n°	length	cat. n°
668mm	26501-L930-D9-00-12	581mm	26346-M930-D9-00-12
948mm	26502-L930-D9-00-12	870mm	26348-M930-D9-00-12
		1150mm	26350-M930-D9-00-12
		1430mm	26352-M930-D9-00-12
		1710mm	26305-M930-D9-00-12
		1990mm	26307-M930-D9-00-12
power:	8.5W - 13W (L)	power:	8.5 - 30W (L) 17W - 60W (M)
flux:	1164lm - 1746lm	flux:	1164lm - 8148lm
CCT:		CCT:	2700K (27) 3000K (30) 4000K (40)
control:	ON/OFF (00)	control:	ON/OFF (00) DALI (DA) ¹ Aqsmart (DB) ¹ switchDIM (SW) ¹

¹ from length 870

luminaire finishes

- white -13 ○
- black -12 ●
- brutal -85 ●

main material

aluminium | PMMA



THIN TUBE twist LED hermetic wall

THIN TUBE

THIN TUBE is a slim, elongated fixture that emits even, diffused light. It works well as subtle wall lighting or illumination for the space below. The twist hermetic version is an excellent choice for evenly lighting the face in front of a bathroom mirror. When tilted forward, the opal diffuser provides soft yet strong light, ideal for makeup, shaving or simply checking your reflection.



THIN TUBE LED
hermetic | twist hermetic

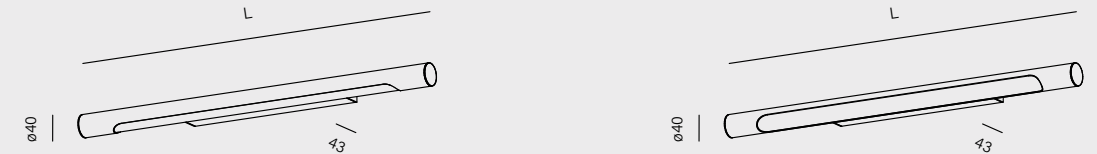

length	cat. n°	length	cat. n°
403mm	20216-M930-D9-00-12	400mm	26556-M930-D9-00-12
683mm	20217-M930-D9-00-12	680mm	26557-M930-D9-00-12
963mm	20218-M930-D9-00-12	960mm	26558-M930-D9-00-12
1243mm	20219-M930-D9-00-12	1240mm	26559-M930-D9-00-12
power:		4.5W - 17W (L) 8.5W - 34,5W (M)	
flux:		582lm - 4656lm	
CCT:		2700K (27) 3000K (30) 4000K (40)	
control:		ON/OFF (00) switchDIM (SW)* DALI (DA)*	

*from length 680mm



luminaire finishes

- white -13 ○
- black -12 ●
- burgundy -86 ●
- terracotta -83 ●
- sandy -87 ●
- taupe -82 ●
- grey -84 ●
- gold -19 ●

main material

aluminium | PMMA

RAFTER

RAFTER emits even light that softly brightens the wall and surrounding space. A variety of length options allows for creating light lines in corridors, lobbies and shared areas, adding character to the interior while ensuring sufficient illumination.

recessed p. 104-114
 surface p. 206-212
 suspended p. 328-330
 track p. 430-438
wall
 systems p. 618



RAFTER LED



length	cat. n°
290mm	20225-M930-D9-00-12
570mm	20226-M930-D9-00-12
860mm	20227-M930-D9-00-12
1140mm	20228-M930-D9-00-12
power:	4.5W - 17W (L) 8.5W - 34.5W (M) 12.5W - 49.5W (H)
flux:	582lm - 6208lm
CCT:	2700K (27) 3000K (30) 4000K (40)
control:	ON/OFF (00) switchDIM (SW) ¹ DALI (DA) ¹ AQsmart (DB) ¹

¹from length 570mm



luminaire finishes

- white -13
- black -12
- brutal -85

main material

aluminium | PMMA

SET TRU

SET TRU offers a variety of lighting effects within a single fixture family. It can emit light downward or in both directions, up and down. It also performs well in high-humidity environments. Its simple, elongated form makes it suitable for both corridors and representative spaces. The hermetic version is a great choice for mirror lighting in bathrooms or public restrooms.

recessed p.122
surface p.224
suspended p.338
Track p.442
wall
systems p.614



SET TRU LED - | hermetic

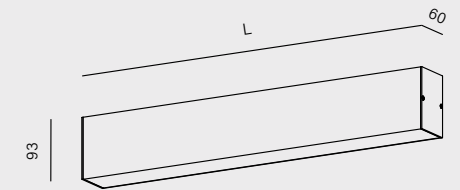

length	cat. n°	length	cat. n°
290mm	24233-M930-D9-00-12	570mm	26363-M930-D9-00-12
570mm	24235-M930-D9-00-12	860mm	26365-M930-D9-00-12
860mm	24237-M930-D9-00-12	1140mm	26367-M930-D9-00-12
1140mm	24239-M930-D9-00-12	1420mm	26369-M930-D9-00-12
1420mm	24241-M930-D9-00-12	1700mm	26397-M930-D9-00-12
1700mm	24243-M930-D9-00-12	1980mm	26399-M930-D9-00-12
1980mm	24245-M930-D9-00-12		
power:	4.5W - 30W (L) 8.5W - 60W (M)		8.5W - 30W (L) 17W - 60W (M)
flux:	582lm - 8148lm		1164lm - 8148lm
CCT:	2700-6500K (62) ¹ 2700K (27) 3000K (30) 4000K (40)		
control:	ON/OFF (00) switchDIM (SW) ² DALI (DA) ² AQsmart (DB) ²		

¹Tunable-White option available from length 1140mm | ²from length 570mm



luminaire finishes

- white -13
- black -12
- brutal -85

main material

aluminium | PMMA | steel



WALL FIXTURES A STYLISH COMPLEMENT TO MODERN INTERIORS



Did you know that the SNOP E27, MODERN BALL and KLIVA E27 luminaries can also be mounted on the wall? And that the PET mini rift luminaire is available as a wall light as well? This makes it easy to match wall lighting to the interior, maintaining a cohesive style and modern design throughout the space. For more details, visit page: [140](#) (SNOP) | [144](#) (KLIVA) | [182](#) (MODERN BALL) | [594](#) (PET RIFT)



Galateria Italia, Belgium

CHILL

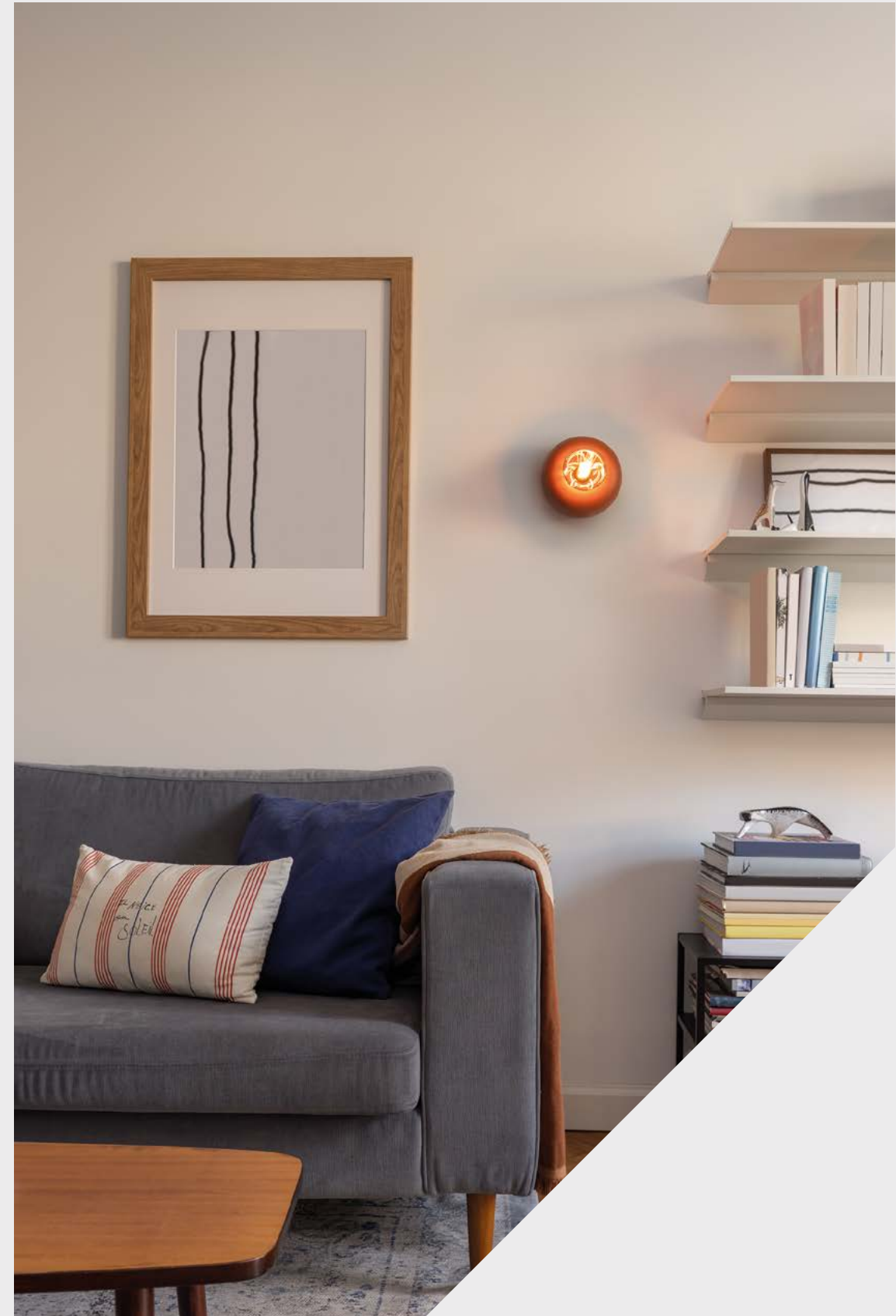

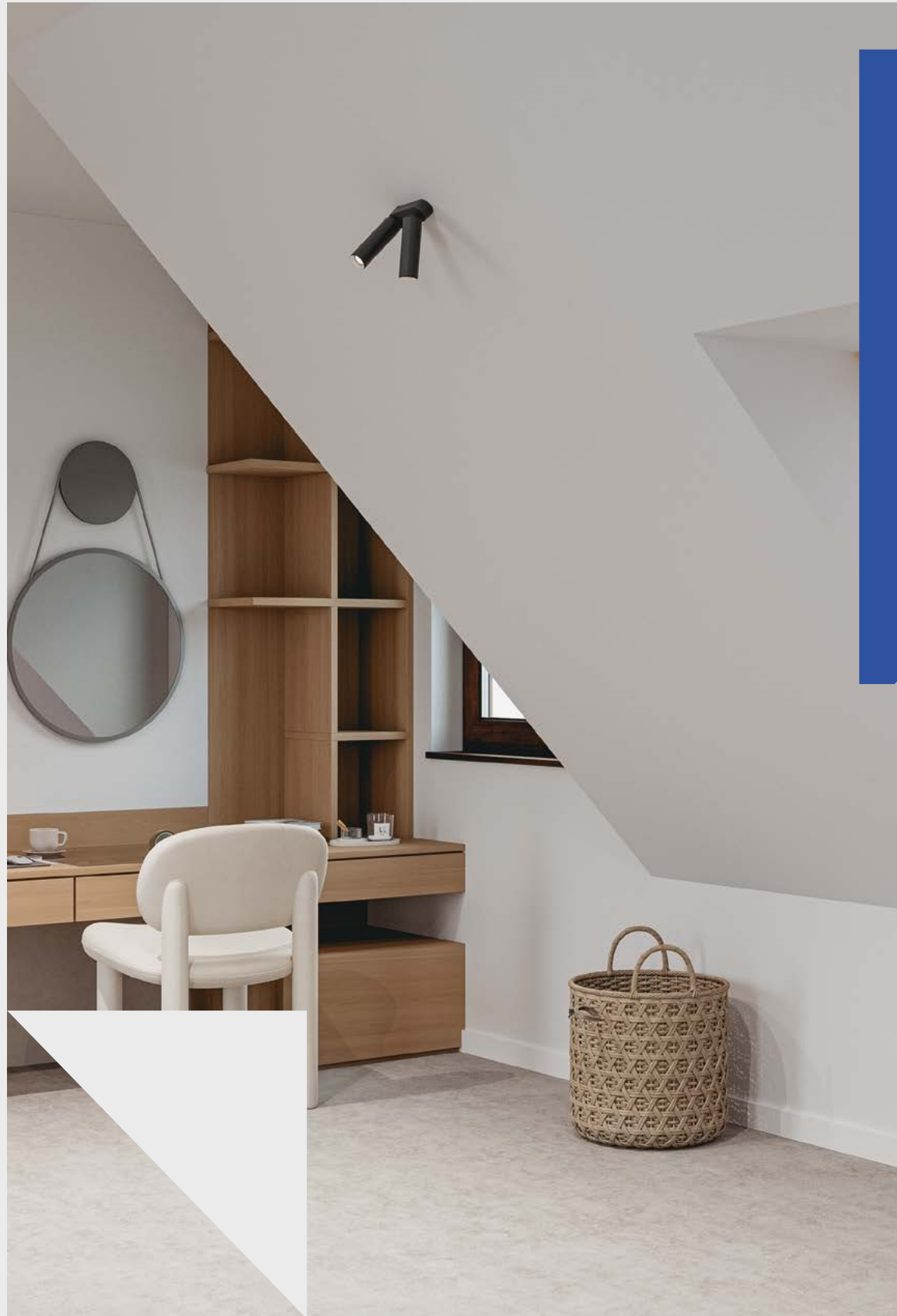

Many luminaires labelled as surface may be installed on both ceilings and walls. MODERN BALL, KLIVA E27 and SNOP E27 work perfectly as wall luminaires without modification. The same applies to the gold-inside MAXI RING dot, the MIDI RING dot and the slightly dimmed BLOS cast. Many adjustable spotlights also fit walls well, as long as their joints can be positioned at the desired angle. This makes them an excellent solution for directional uplighting.

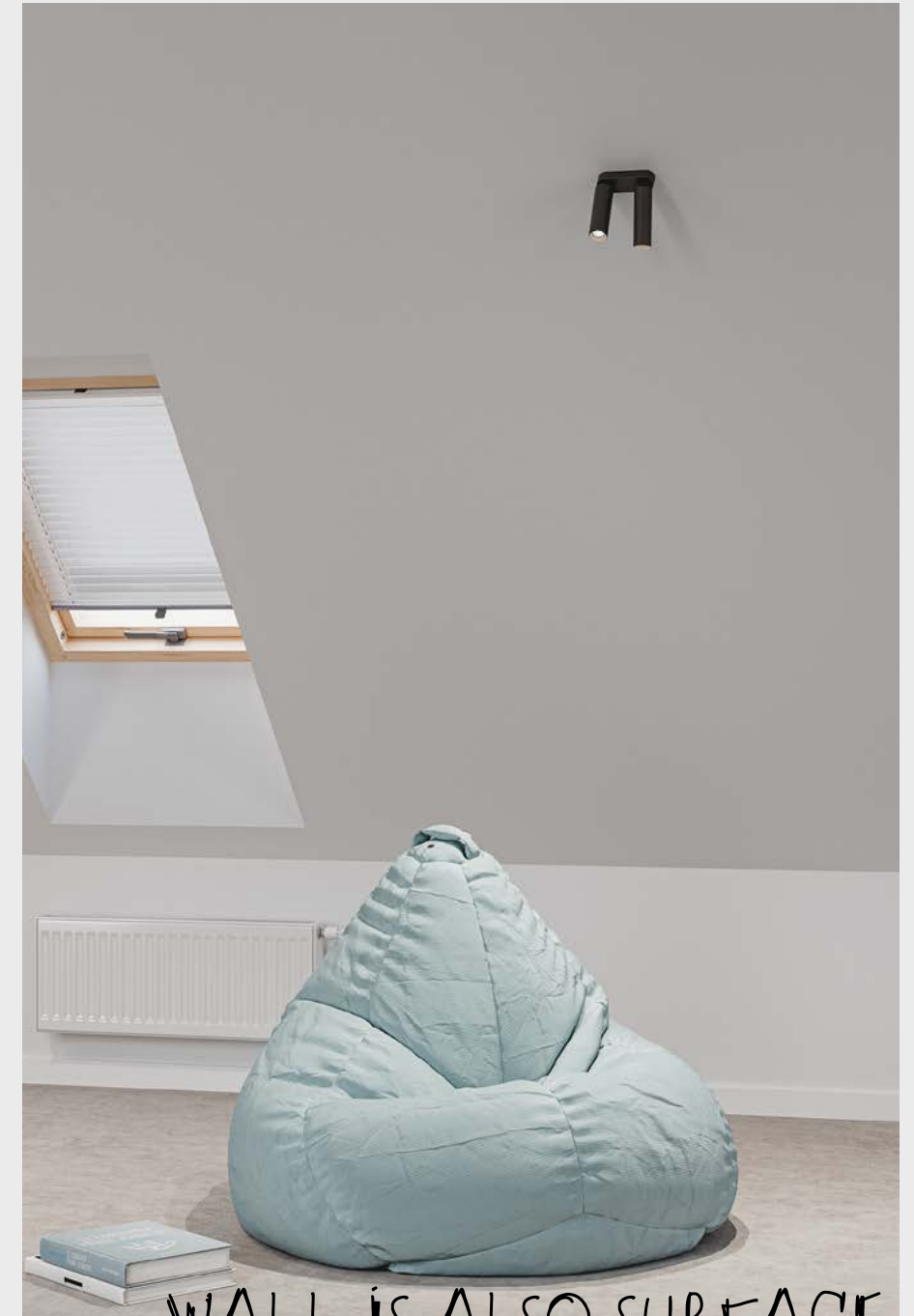

You can also install the PET mini E LED spot as a wall-mounted fixture.

WALL IS ALSO SURFACE

INTERIOR FLOOR — TABLE PORTABLE PRODUCTS

PORTABLE | IP-RATED

MROOM
table



[p. 510](#)

MROOM
upright



[p. 510](#)

TABLE
MODERN BALL
table



[p. 514](#)

FLOOR
PET micro
upright



[p. 518](#)

THIN TUBE
upright



[p. 520](#)

LIGHT
ALWAYS

AT HAND

INTERIOR FLOOR—TABLE PORTABLE

Freestanding and table luminaires help create atmosphere in areas where fixed light sources do not reach. They work well on a terrace during dinner, at a lobby table, or in a guest room, adding flexibility and ambience to the interior while serving its users.

MODERN BALL LED table



THIN TUBE LED upright



MROOM LED exterior table



MROOM_

MROOM is designed for spaces where freedom matters: on a restaurant table, in a hotel lobby, or on a terrace during an evening gathering. Its durable battery and water-resistant body allow it to be used anywhere. Available in both table and taller floor versions, it supports a variety of usage scenarios.



MROOM LED exterior table | upright

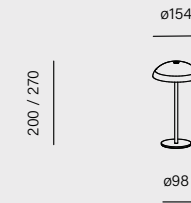

cat. n°

26576-M930-D9-TD-12

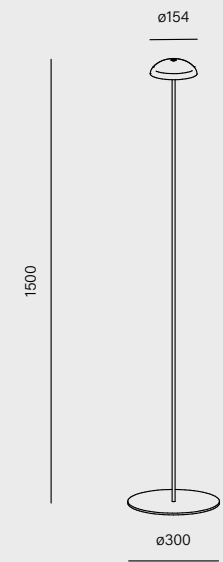

cat. n°

26580-M930-D9-TD-12

power:	4W (M)
flux:	587lm
CCT:	2700K (27) 3000K (30)
control:	Touch Dim (TD)



Battery life: min. 500 cycles. Replaceable battery. USB C charging, time 8h at 2A.



luminaire finishes

- white -13
- black -12
- burgundy -86
- terracotta -83
- sandy -87
- taupe -82
- grey -84
- gold -19

main material

aluminium | steel | PC

MROOM LED upright



MROOM LED exterior table

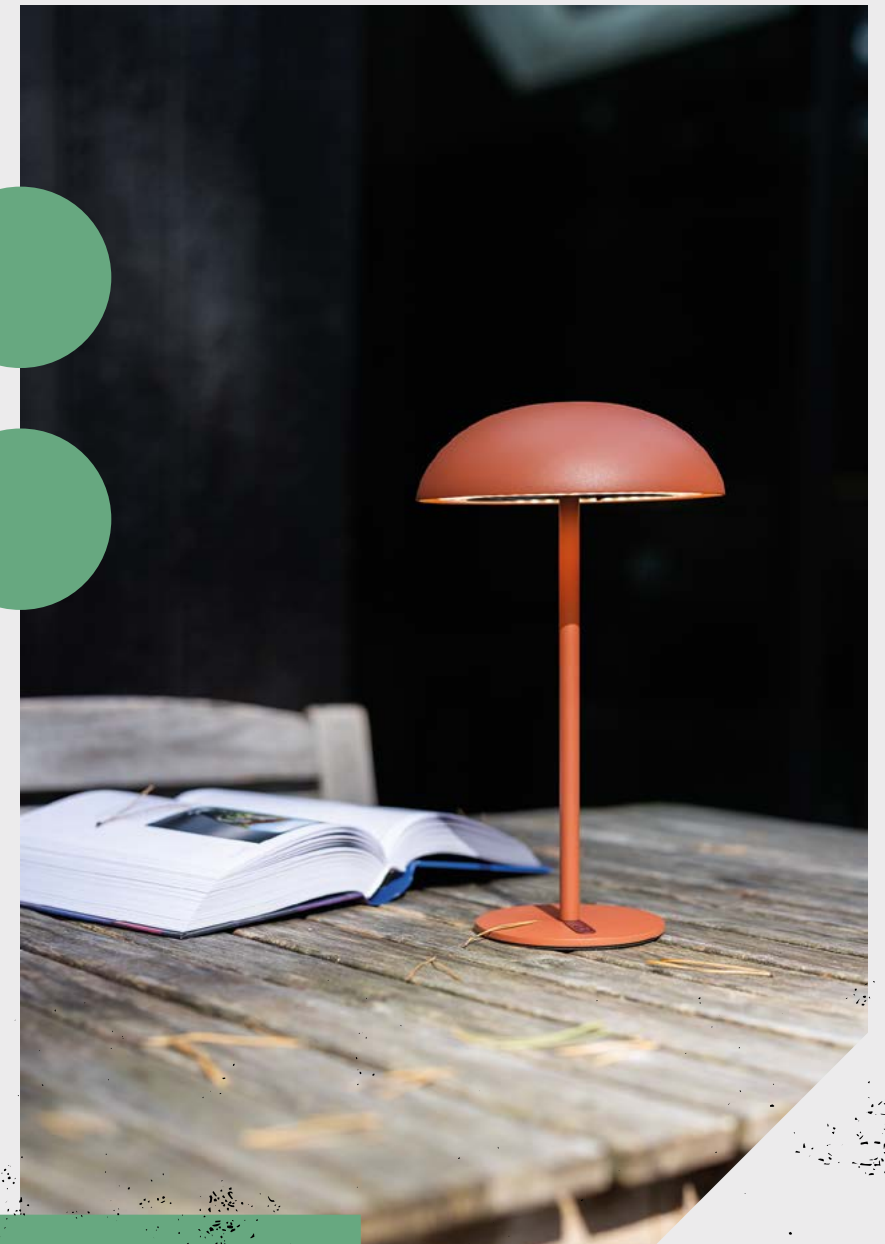

MODERN BALL PW LED table

Monte Marcella, Ledegem

A classic ball that has long been a symbol of purity and harmony. MODERN BALL LED Table brightens spaces in lobbies, reception areas, and residential interiors, offering calm, even illumination. Its neutral form pairs well with various materials and arrangements, creating an atmosphere that complements rather than competes with the architecture.

MODERN BALL

MODERN BALL

LIGHT, ALWAYS AT HAND

surface p. 178-182
suspended p. 296-298
Track p. 448
upright
systems p. 584



MODERN BALL PW LED table

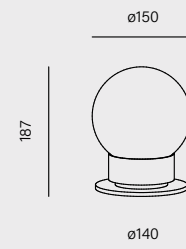

cat. n°

26550-M930-PW-00-12

power:	6W (L) 8.5W (M)
flux:	794lm - 1097lm
CCT:	2700K (27) 3000K (30) 4000K (40)
control:	ON/OFF (00)



The luminaire is supplied with a 1800mm cable with an on/off switch and a plug.

luminaire finishes

- white -13
- black -12
- burgundy -86
- terracotta -83
- sandy -87
- taupe -82
- grey -84
- gold -19

main material

aluminium | glass



www.aqform.com

Data for standard LED product is shown for LED light source 3000K. Other variants are available on our website.

515

514

Design: Rexel | Photo: I am Liz

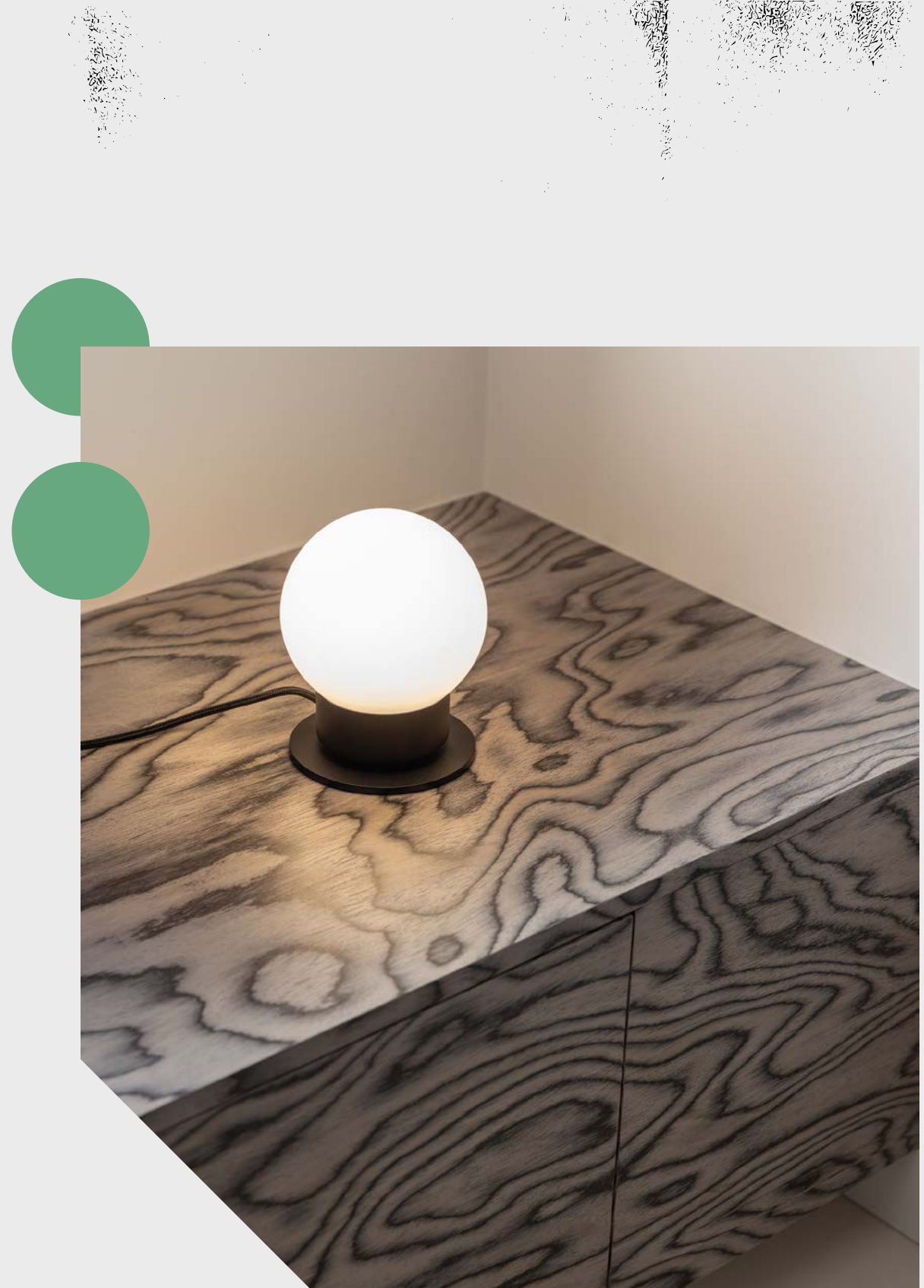

PET

PET micro in its freestanding version works well next to an armchair, a side table, or in a hotel lobby. It directs light precisely, highlighting a selected element or supporting reading. Its slim, unobtrusive form makes it a discreet and practical complement to the main lighting where required.



PET micro LED upright

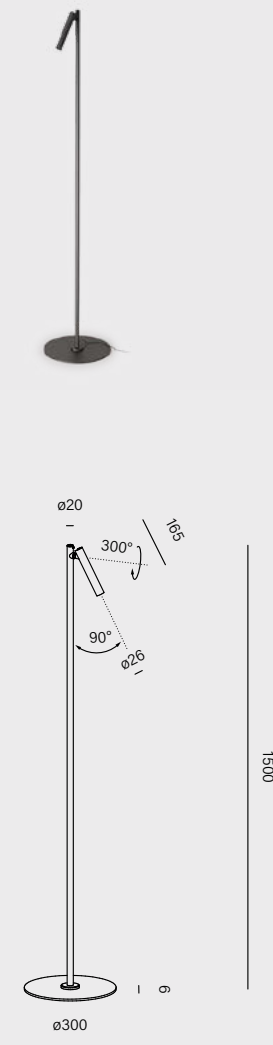

cat. n°	
26569-M930-F3-00-12	
power:	2.5W (M)
flux:	223lm
optics:	32° (F ₋)
CCT:	2700K (27) 3000K (30) 4000K (40)
control:	ON/OFF (00)



The luminaire is supplied with a 1400mm cable with an on/off switch on the luminaire and a plug with integrated power supply.



luminaire finishes

- white -13 ○
- black -12 ●
- burgundy -86 ●
- terracotta -83 ●
- sandy -87 ●
- taupe -82 ●
- grey -84 ●
- gold -19 ●

main material

aluminium | steel

THIN TUBE

THIN TUBE introduces vertical light with a soft character into the interior. It works well next to a sofa, in a corner, or in any nook worth illumination and benefiting from softly reflected light from the nearest wall.

suspended n. 316
wall n. 492
upright



THIN TUBE LED upright

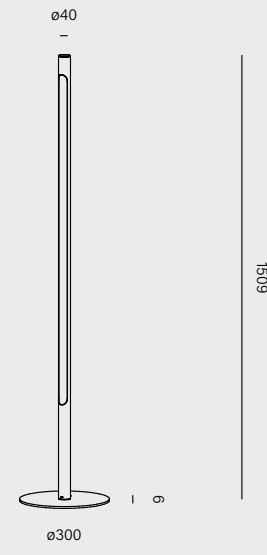

cat. n°

26551-M930-D9-00-12

power: 17W (L) | 34.5W (M)

flux: 2328lm - 4656lm

CCT: 2700K (27) | 3000K (30) | 4000K (40)

control: ON/OFF (00) | switchDIM (SW)



The luminaire is supplied with a 1800mm cable with an on/off switch and a plug.

luminaire finishes

- white -13 ○
- black -12 ●
- burgundy -86 ●
- terracotta -83 ●
- sandy -87 ●
- taupe -82 ●
- grey -84 ●
- gold -19 ●

main material

aluminium | steel | PMMA



EXTERIOR 
- **OUTDOOR**



ARCHITECTURE
IN THE LIGHT
OF NATURE

EXTERIOR - OUTDOOR - PRODUCTS

RECESSED
ONLY round mini
recessed



[p. 536](#)

SURFACE
ONLY round mini
surface



[p. 536](#)

PET
surface



[p. 538](#)

WALL
SENSO
wall



new

[p. 534](#)

LEDPOINT round
wall



[p. 540](#)

LEDPOINT round
up&down wall



[p. 540](#)

LEDPOINT square
wall



[p. 540](#)

LEDPOINT square
up&down wall



[p. 540](#)

VIP round
wall



[p. 544](#)

VIP round up&down
wall



[p. 544](#)

VIP square
wall



[p. 544](#)

VIP square up&down
wall



[p. 544](#)

MAXI POINT
wall



[p. 548](#)

DART
spot



[p. 558](#)

UPRIGHT
KYO 24V
upright



new

[p. 532](#)

MAXI POINT
upright



[p. 548](#)

SLUP
upright



[p. 552](#)

DART 24V
upright



new

[p. 556](#)

DART
upright



[p. 558](#)

EXTERIOR — OUTDOOR —

AQForm outdoor luminaires combine aesthetics with functionality and durability. They illuminate paths, facades and greenery, highlighting the details of the surroundings. They create a harmonious and safe lighting arrangement around the house and in the garden.

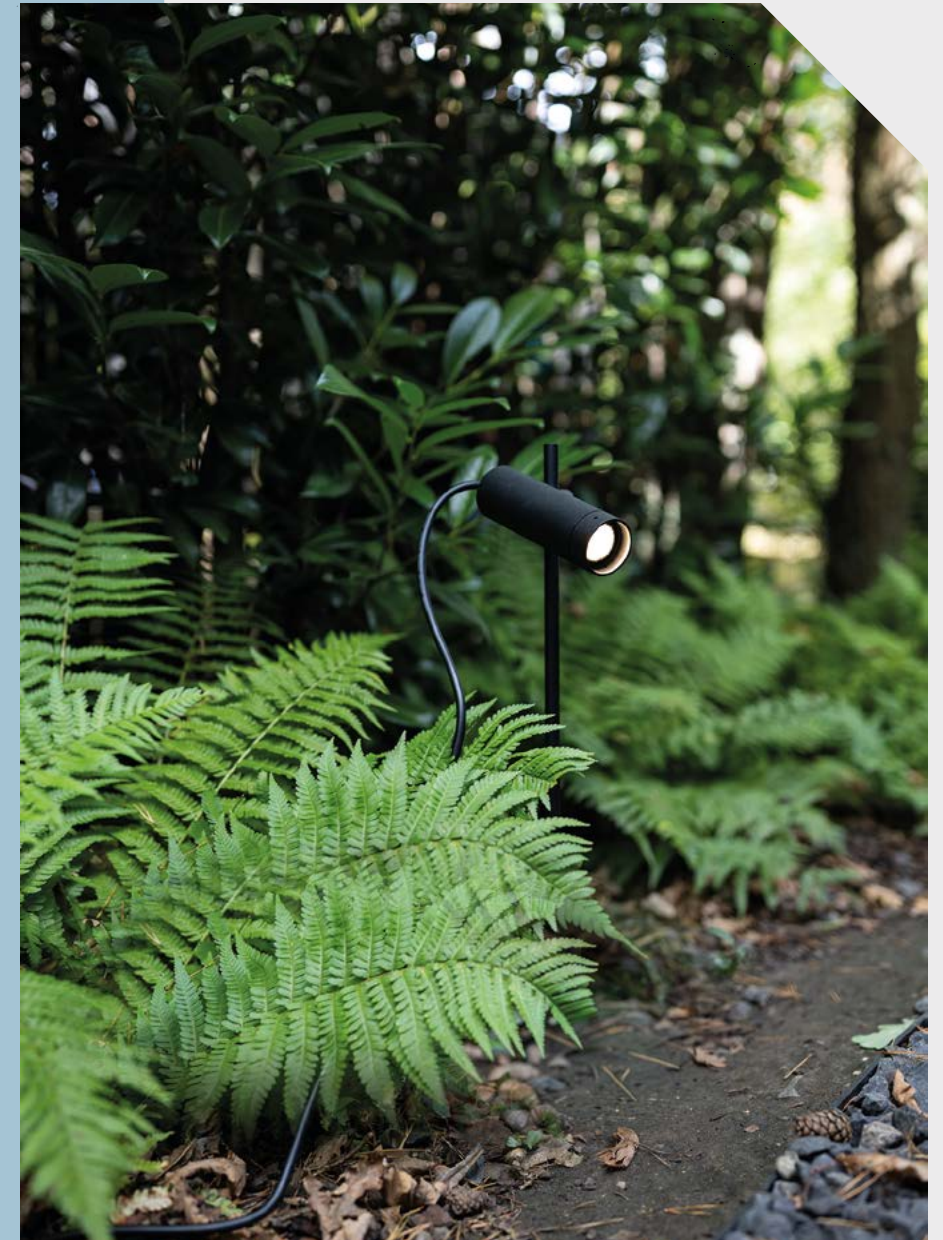

DART LED exterior upright



On the following pages, you will find spotlights for highlighting greenery, bollards guiding light along pathways, wall lights accentuating façades after dusk and surface-mounted luminaires designed for loggias and porches. All luminaires in this collection share high resistance to weather conditions, durable finishes suited to outdoor environments and high ingress protection ratings.

LIGHT
THAT DEFINES
OUTDOOR SPACE

WHAT'S NEW

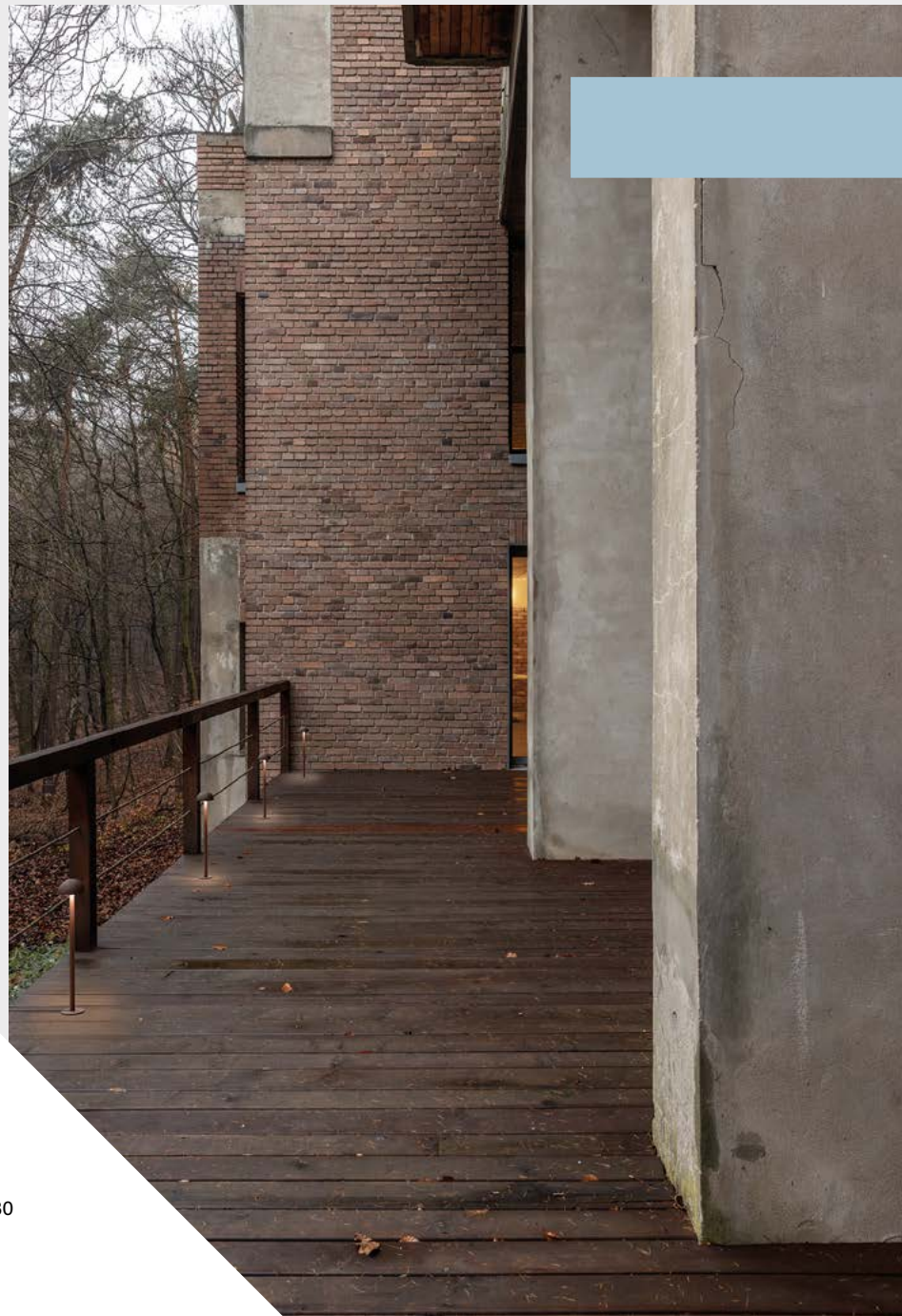

Among the introduced improvements are solutions that expand the possibilities for using luminaires in outdoor spaces. The low-voltage 24V version increases user safety, making it easier to route wiring on site. The range is complemented by a new corten finish and a 2200K colour temperature, enabling an even warmer and more atmospheric lighting effect.

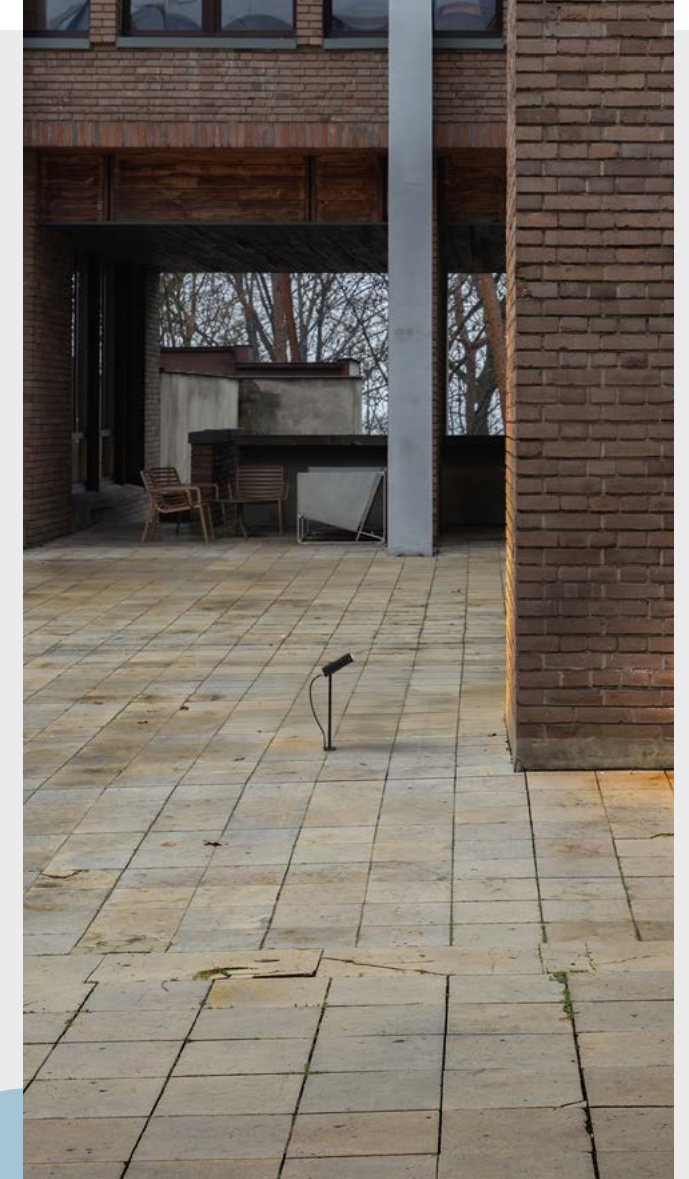

KYO LED 24V exterior upright

KYO

KYO is an outdoor bollard luminaire designed for illuminating garden areas, terraces and residential surroundings. It emits diffused downward light, evenly brightening the area beneath the fixture. Available in three heights and two finishes, it performs well when lighting floors, pathways and small recreational zones. The 24V power supply increases user safety and facilitates installation.



NEW PRODUCT

KYO LED 24V upright

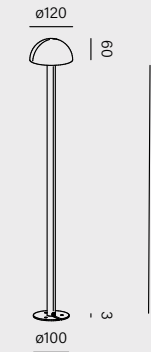

length	cat. n°
400mm	26603-M930-D9-CV-12
600mm	26604-M930-D9-CV-12
800mm	26605-M930-D9-CV-12
power:	5W (M)
flux:	793lm
CCT:	2200 (22) 2700K (27) 3000K (30)
control:	constant voltage (CV)



24V power supply required.

A detailed presentation of the 24V system can be found in the [technical brochure](#).

accessory

81311 - KYO ground spike



luminaire finishes

- black -12 ●
- corten -88 ●

main material
aluminium | PC

SENSO LED exterior wall

SENSO_

SENSO is a wall-mounted luminaire designed for installation close to the ground and intended for lighting walkways. Its emission of intense, diffused light improves visibility after dark and supports spatial orientation. A finish resembling black-painted concrete emphasises the texture of the fixture and gives it a raw, technical character suitable for outdoor use.



NEW PRODUCT

SENSO LED wall

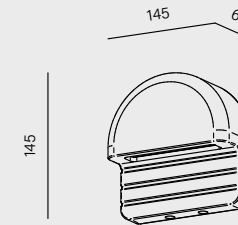

cat. n°	
26606-M930-D9-00-12	
power:	4.5W (M)
flux:	586lm
CCT:	2200 (22) 2700K (27) 3000K (30)
control:	ON/OFF (00)



www.aqform.com

Data for standard LED product is shown for LED light source 3000K. Other variants are available on our website.

luminaire finishes

black -12 ●

main material

concrete | aluminium

ONLY round mini LED 230V exterior surface

ONLY

ONLY is a luminaire that performs well in a variety of scenarios, from lighting covered outdoor areas to accentuating entrance zones. Available in both surface-mounted and recessed versions, it enables a cohesive lighting layout across terraces, loggias and passageways. Its discreet form harmoniously complements the architecture.



exterior

ONLY

ARCHITECTURE IN THE LIGHT OF NATURE



**ONLY round mini LED 230V
recessed | surface**

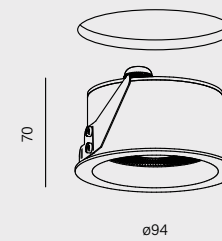

∅ 94mm | Hmin: 80mm

cat. n°

38049-M930-F3-PH-12

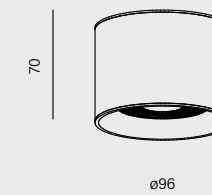

∅ 96

cat. n°

47018-M930-F3-PH-12

power:	8W (M)
flux:	680lm
optics:	26° (F_) 40° (W_) opal (D9)
CCT:	2200K (22) 2700K (27) 3000K (30) 4000K (40)
control:	Phase-Control (PH)

luminaire finishes

- white -13 ○
- black -12 ●
- corten -88 ●
- burgundy -86 ●
- terracotta -83 ●
- sandy -87 ●
- taupe -82 ●
- grey -84 ●
- gold -19 ●

¹indoor use only

main material
aluminium | PC



recessed p. 092
 surface p. 162-164
 suspended p. 304-306
 track p. 416-420
 wall p. 472
exterior
 systems p. 584

PET LED 230V exterior surface

PET was designed with covered outdoor spaces in mind, such as porches, loggias and entrance zones. It provides precise lighting that supports orientation after dark and highlights architectural features. The luminaire's discreet form maintains visual coherence with its surroundings, creating an orderly rhythm of light points.



PET LED 230V surface

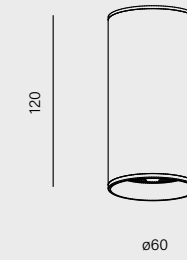

cat. n°	
47029-M930-F3-PH-12	
power:	8W (M)
flux:	680lm
optics:	27° (F_)
CCT:	2200K (22) 2700K (27) 3000K (30) 4000K (40)
control:	Phase-Control (PH)

luminaire finishes

- white -13 ○
- black -12 ●
- corten -88 ●
- burgundy -86 ●
- terracotta -83 ●
- sandy -87 ●
- taupe -82 ●
- grey -84 ●
- gold -19 ●

¹indoor use only

main material
aluminium



PET

LEDPOINT

LEDPOINT is a compact facade luminaire available in round and rectangular versions. It emits precise light in one or two directions, emphasising the texture of the façade and architectural details. The light source, deeply recessed within the housing, remains hidden from view, creating a visually interesting and eye-friendly result. Used near entrances and on terrace walls, it introduces a balanced lighting accent with a decorative character.



LEDPOINT wall
round | square

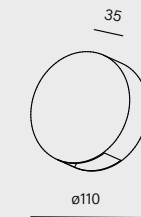

cat. n°

26544-M930-WB-00-12

power:	3W (M)
flux:	389lm
optics:	68° (W_)
CCT:	2200K (22) 2700K (27) 3000K (30)
control:	ON/OFF (00)

LEDPOINT up&down wall
round | square

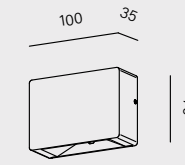

cat. n°

26546-M930-WB-00-12

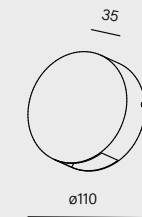

cat. n°

26545-M930-WB-00-12

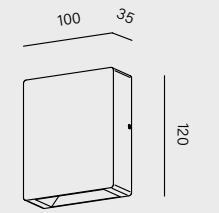

cat. n°

26547-M930-WB-00-12

power:	3W (M)	6W (M)
flux:	389lm	778lm
optics:	68° (W_)	
CCT:	2200K (22) 2700K (27) 3000K (30)	
control:	ON/OFF (00)	



- | | |
|-----------------------|---------------------------|
| inner finishes | luminaire finishes |
| white -_W ○ | white -13 ○ |
| black -_B ● | black -12 ● |
| corten -_O ● | corten -88 ● |

every color variant of the luminaries can only be ordered with its equivalent (e.g.-12 and -_B)

main material
aluminium



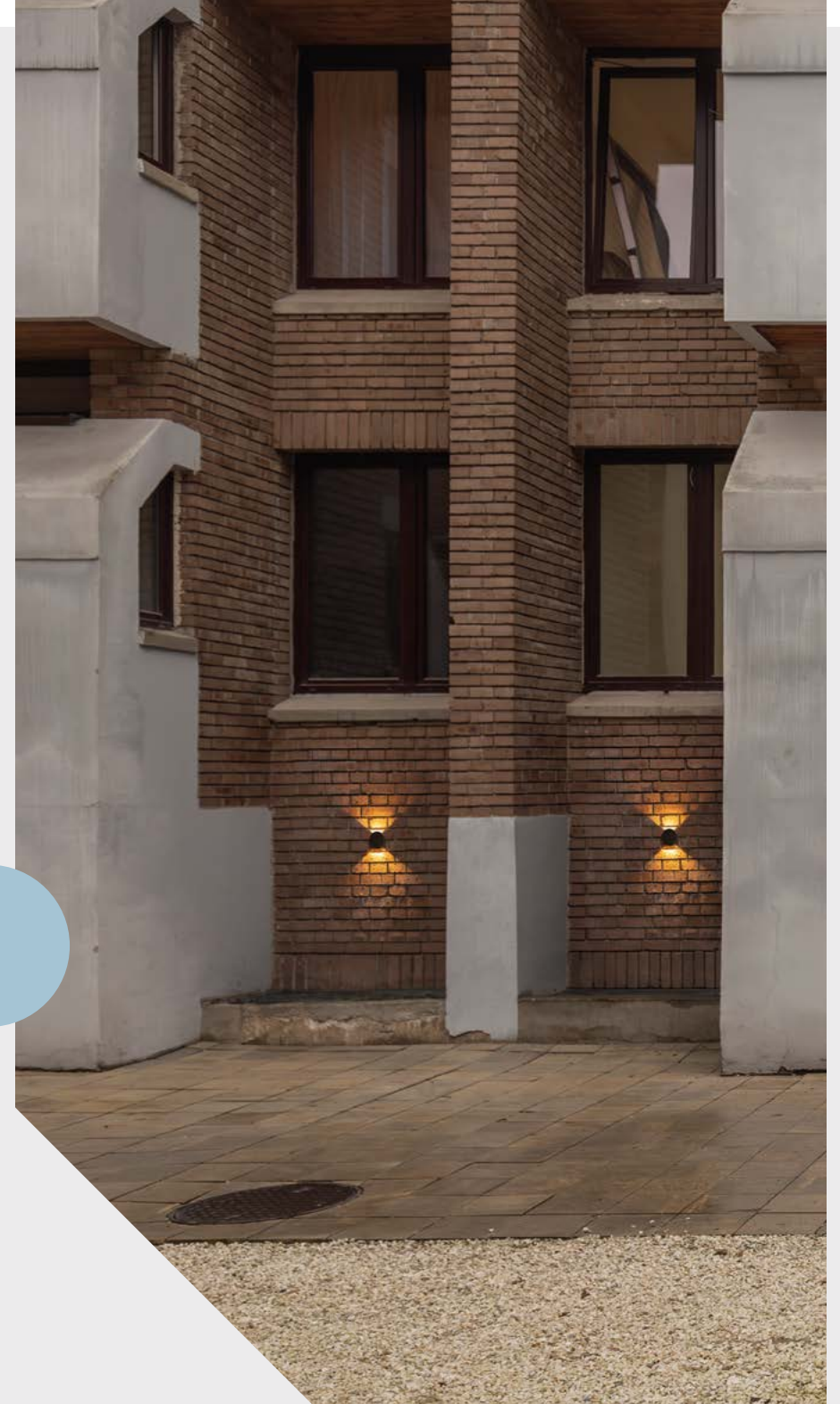

DECORATIVE
LIGHTING ACCENTS
ON THE FAÇADE

VIP



VIP LED 230V wall
round | square

VIP up&down LED 230V wall
round | square

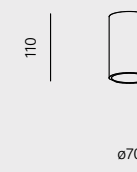

cat. n°

26540-M930-WB-PH-12

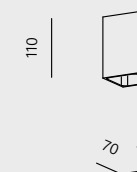

cat. n°

26542-M930-WB-PH-12

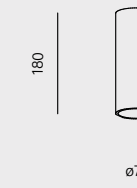

cat. n°

26541-M930-WB-PH-12

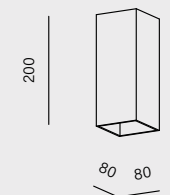

cat. n°

26543-M930-WB-PH-12

power:	6W (M)		12W (M)	
flux:	510lm		1020lm	
optics:	64° (WB) 71° (WW) ¹	60° (WB) 65° (WW) ¹	64° (WB) 71° (WW) ¹	60° (WB) 65° (WW) ¹
CCT:	2200K (22) 2700K (27) 3000K (30)			
control:	Phase-Control (PH)			



¹The beam angle depends on the finish colour.



- inner finishes**
- white -_W ○
 - black -_B ●
 - corten -_O ●
- luminaire finishes**
- white -13 ○
 - black -12 ●
 - corten -88 ●

every color variant of the luminaries can only be ordered with its equivalent (e.g.-12 and -_B)

main material
aluminium

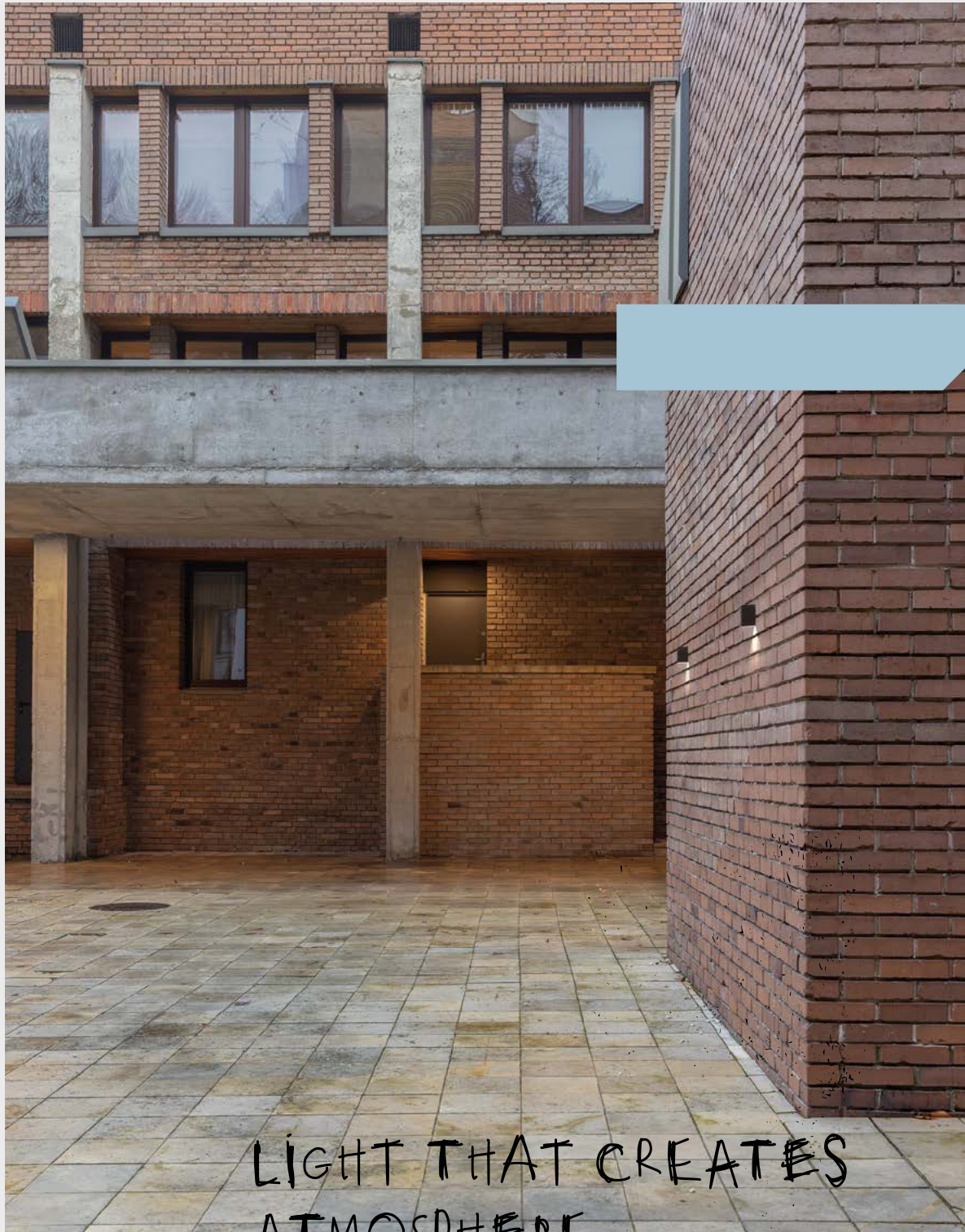

LIGHT THAT CREATES
ATMOSPHERE
AND ORDER AFTER DARK



VIP is a wall light with refined proportions and an elegant character. Available in versions directing light downward or both upward and downward, and in two shapes, it is used near entrances and on building façades to introduce soft, decorative lighting accents that enhance the aesthetics of the space after dark.

MAXI — point

MAXI POINT is a family of outdoor luminaires that includes wall lights and bollards. It supports the creation of cohesive lighting around the building, from entrances and terraces to garden paths. Its bright, soft light increases safety and ease of use while highlighting the structure of the surroundings after dark, with the light source remaining completely shielded.



MAXI POINT LED round wall | upright

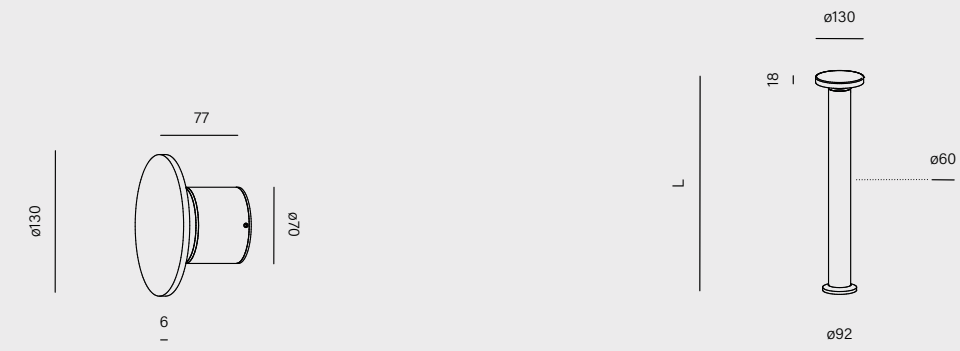

	cat. n°	length	cat. n°
	26579-M930-D9-00-12	250mm	26581-M930-D9-00-12
		600mm	26578-M930-D9-00-12
		1000mm	26577-M930-D9-00-12
power:	4.5W (M)		6W (M)
flux:	543lm		794lm
CCT:	2200K (22) 2700K (27) 3000K (30)		
control:	ON/OFF (00)		



luminaire finishes

- black -12 ●
- corten -88 ●

main material

aluminium | PMMA (round wall) | optical glass (upright)



MAXI POINT wall lights and bollards form a logical and elegant whole. On façades, they introduce balanced lighting accents, while in the garden they guide movement and organise space. A unified design and proportions ensure that all elements in the family harmonise with both architecture and greenery.

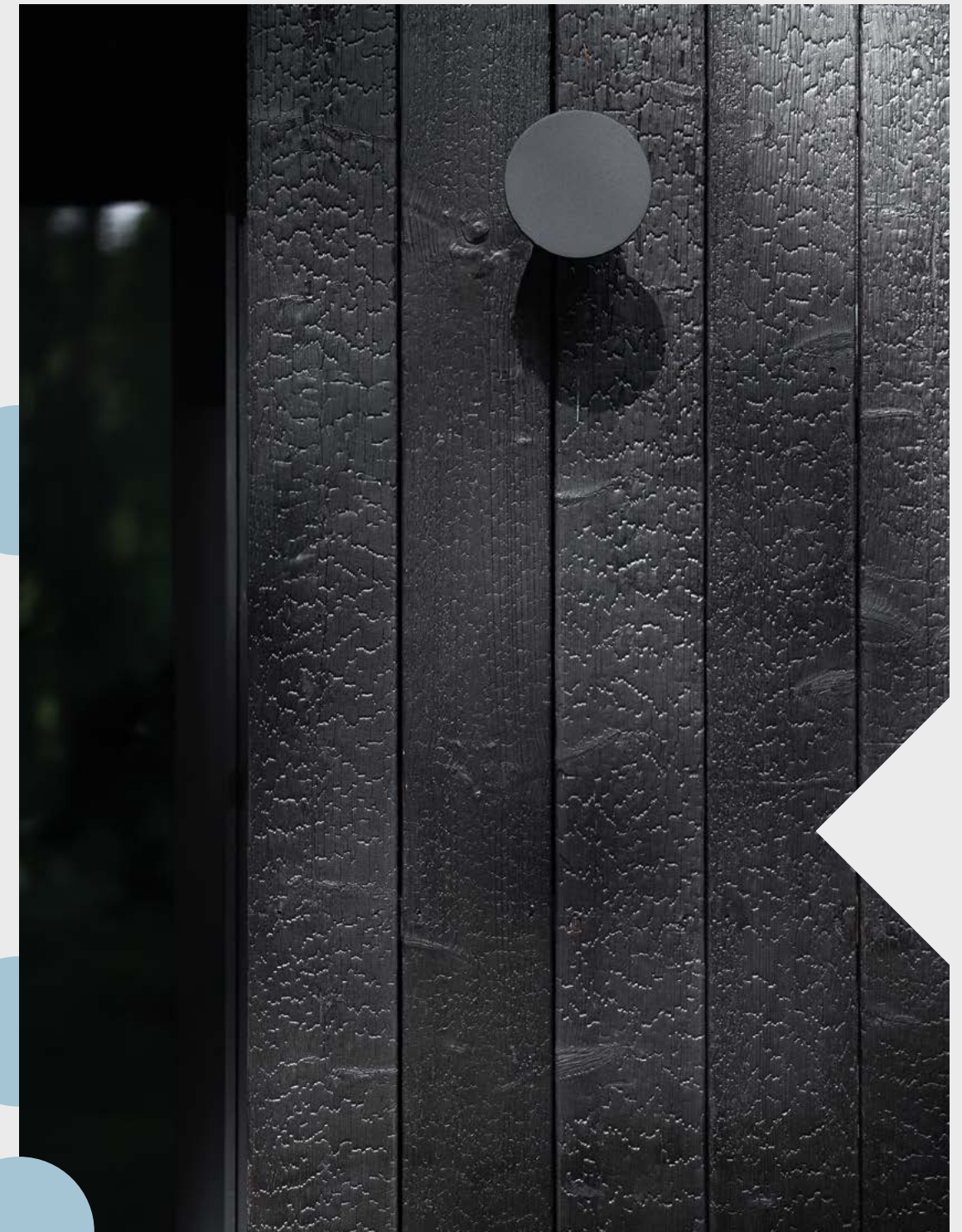

SLUP LED exterior upright

Private house, Brzezie

SLUP _

SLUP
exterior

ARCHITECTURE IN THE LIGHT OF NATURE

SLUP LED upright

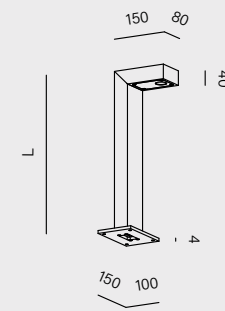

length	cat. n°
450mm	26548-M930-D0-00-12
600mm	26549-M930-D0-00-12
power:	9W (M)
flux:	1027lm
CCT:	2200K (22) 2700K (27) 3000K (30)
control:	ON/OFF (00)



luminaire finishes

- black -12 ●
- corten -88 ●

main material

aluminium



www.aqform.com

Data for standard LED product is shown for LED light source 3000K. Other variants are available on our website.

553

552

Design: Przestrzeń Agnieszka Klimek

LIGHT THAT GUIDES AND BUILDS SAFETY

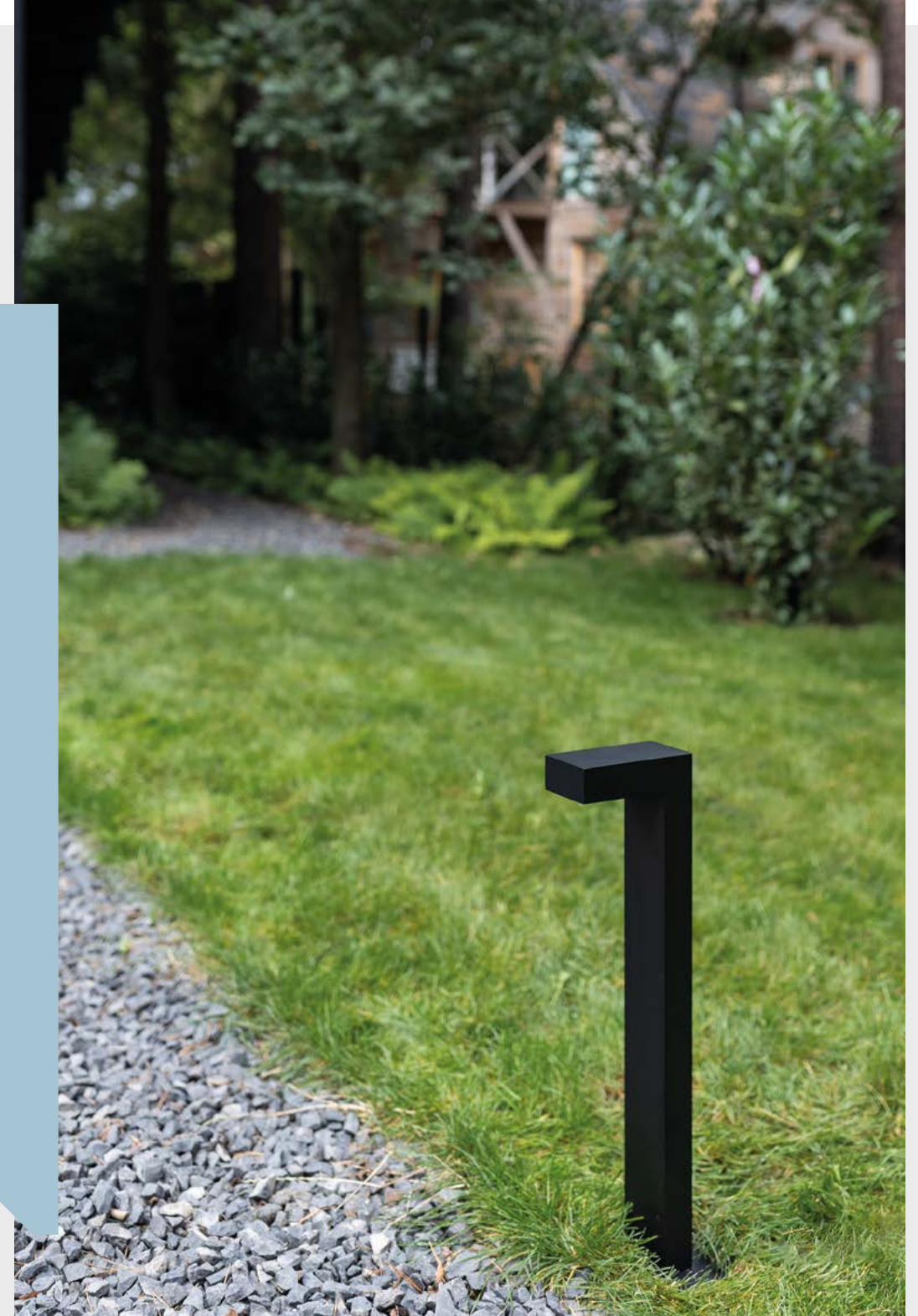

SLUP is a bollard luminaire available in two heights, designed for lighting paths, driveways and garden walkways. It emits gentle light that increases safety after dark. Its subtle design and durable construction allow it to integrate well with the building's surroundings.

DART_24V

DART LED 24V upright is a low-voltage version of the well-known DART spotlight, designed to enhance safety of use in outdoor spaces. It retains the character and performance of the standard luminaire, providing directional lighting for greenery and architectural elements while operating on a safe 24V power supply.



NEW PRODUCT



DART LED 24V upright

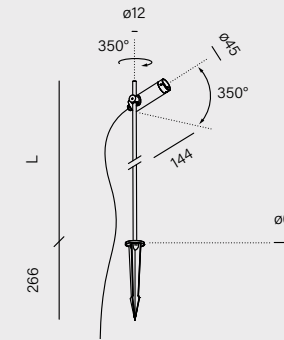



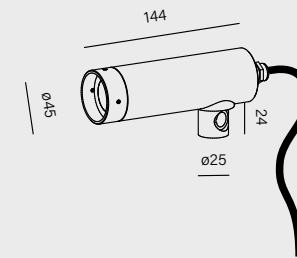

DART LED 24V engine accessory



length	cat. n°	cat. n°
120mm	26595-M930-F1-CV-12	81255-M930-F1-CV-12
380mm	26594-M930-F1-CV-12	
1000mm	26608-M930-F1-CV-12	

power:	3W (M)
flux:	389lm
optics:	33° (F_)
CCT:	2200K (22) 2700K (27) 3000K (30)
control:	constant Voltage (CV)

24V power supply required.

A detailed presentation of the 24V system can be found in the [technical brochure](#).

* If a double version is needed, DART LED engine can be added to 380mm or 1000mm rod single version



luminaire finishes

- black -12 ●
- corten -88 ●

main material

aluminium

DART LED exterior upright

DART

DART is an outdoor spotlight designed for illuminating greenery and architectural elements. Thanks to its adjustable tilt angle, it allows light to be directed precisely onto trees, shrubs or garden details. It also performs well when highlighting walls and spatial compositions, creating a cohesive lighting effect around the home.



DART LED spot | upright

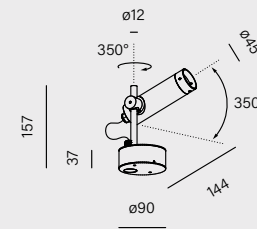

cat. n°

16444-M930-F1-00-12

length

120mm
380mm
1000mm

cat. n°

26538-M930-F1-00-12
26539-M930-F1-00-12
26565-M930-F1-00-12

power:

3W (M)

flux:

389lm

optics:

33° (F_L)

CCT:

2200K (22) | 2700K (27) | 3000K (30)

control:

ON/OFF (00)



DART LED engine accessory¹

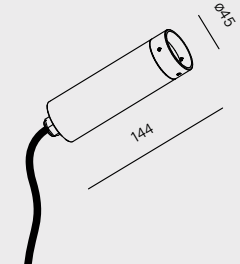
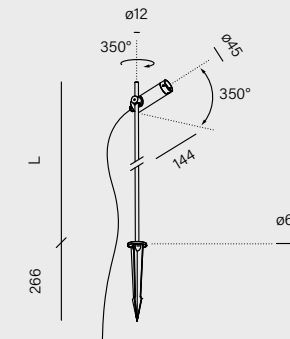

cat. n°

81219-M930-F1-00-12

¹ If a double version is needed, DART LED engine can be added to 380mm or 1000mm rod single version

luminaire finishes

- black -12
- corten -88

main material

aluminium



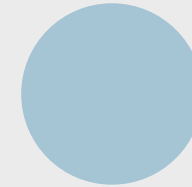
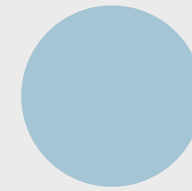

LIGHT THAT
HIGHLIGHTS
THE BEAUTY
OF DETAILS



INTERIOR SYSTEMS



CREATE
WITHOUT BOUNDARIES

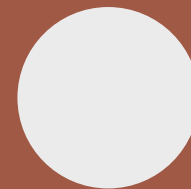
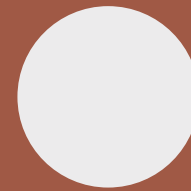
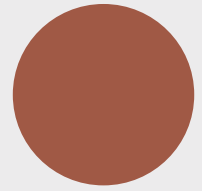
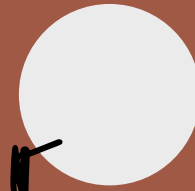
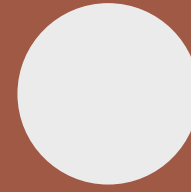

INTERIOR SYSTEMS



PRODUCTS

BEADS

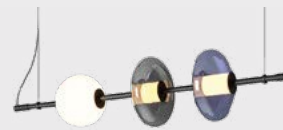

new

[p. 572](#)

OPTIMA



new

[p. 578](#)

PIPER

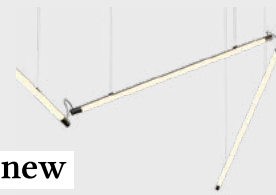

new

[p. 590](#)

PET rift suspended



[p. 596](#)

PET rift wall



[p. 596](#)

PET rift surface



[p. 596](#)

MODERN GLASS
SPIDER



[p. 584](#)

MODERN GLASS mini
SPIDER



[p. 584](#)

MODERN BALL
SPIDER



[p. 584](#)

QRLED next
SPIDER



[p. 584](#)

ALULINE

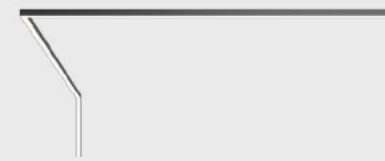

[p. 600](#)

LEDLINE soft

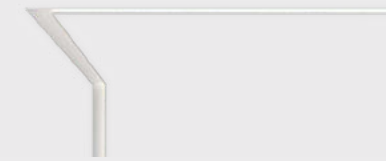

[p. 602](#)

MIXLINE



[p. 606](#)

IKI
SPIDER



[p. 584](#)

MAXI POINT
SPIDER



[p. 584](#)

TRIBA
SPIDER



[p. 584](#)

PET
SPIDER



[p. 584](#)

RAW mini

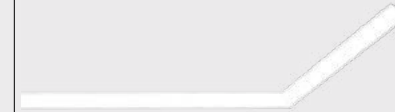

[p. 610](#)

TRU



[p. 614](#)

RAFTER mix



[p. 618](#)

INTERIOR SYSTEMS



Our systems provide consistent, functional solutions that enable precise light guidance within a space. They make it easier to create diverse layouts tailored to architectural concepts and user needs.

PET midi rift LED surface

Hotel Glar

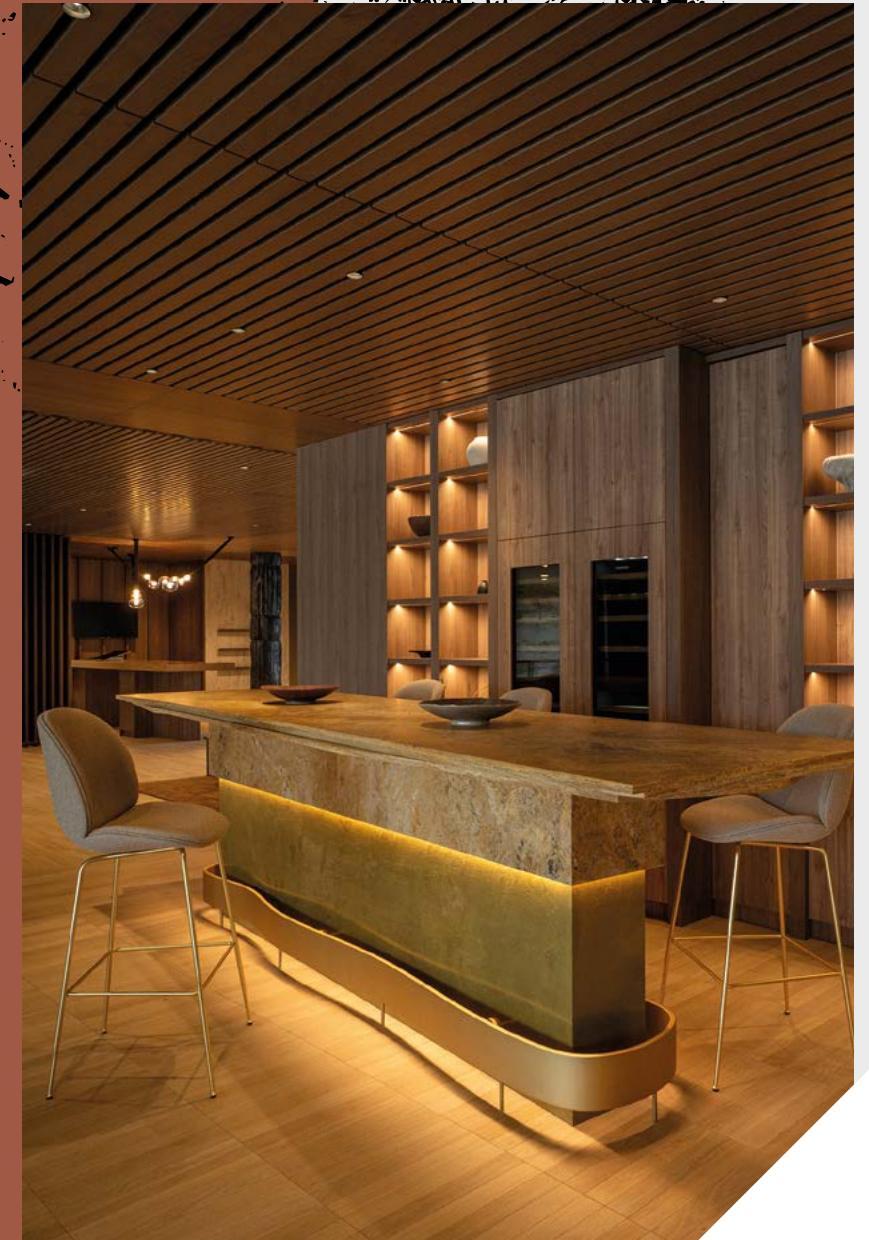

REGULAR SYSTEM

Regular systems allow the creation of complete, multi-element lighting arrangements based on standard profiles and modules. Both simple lines and more advanced structures can be formed, using different light types and mounting options. As a result, they work well in a wide range of spaces, offering extensive configuration and application options that can be easily adapted to the specifics of a project.



The 1970s cube-style house, Zielona Góra

PIPER system LED suspended

LEDLINE soft LED recessed | SET RAW mini LED suspended



BEADS

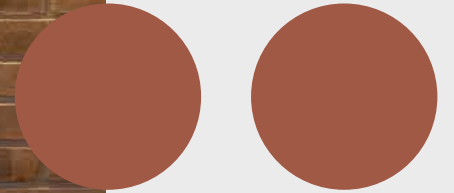

The system version of BEADS is based on the microtrack rail and allows for flexible configuration of luminaires in both vertical and horizontal arrangements. This solution makes it possible to create light, decorative installations as well as more complex setups which, when using a larger number of opal elements, can also serve as a source of general lighting.

HOW TO USE SYSTEM

1. Choose your mounting

Select between horizontal or vertical version, for horizontal version specify the profile length.

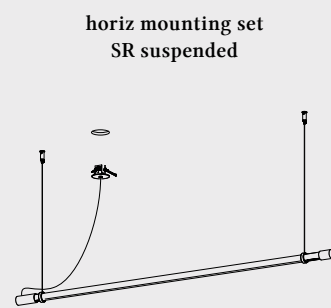
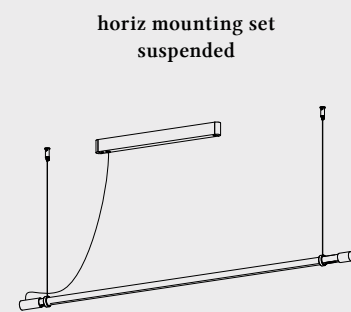

vert mounting set suspended



2. Choose your plain

Decide on the number and shapes of the light modules.

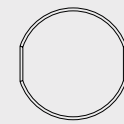

ball



disc



cone

3. Choose the finish for each module

plain white - PW ○



plain graphite - PJ ●



plain fuchsia - PF ●



plain indygo - PI ●



4. Arrange the shades in the order that matches the concept

example assembly BEADS system with horiz 120 mounting set

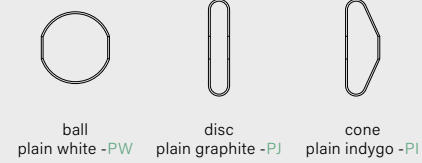

example assembly BEADS system with horiz 200 SR mounting set

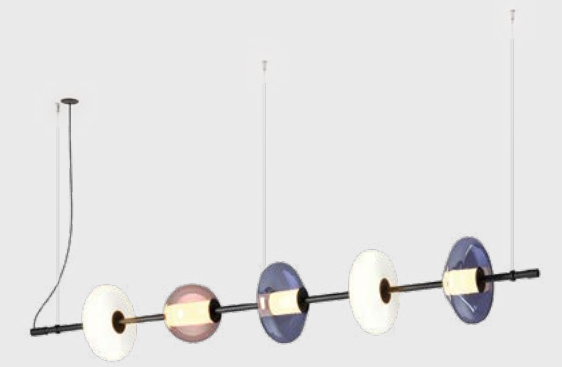

example assembly BEADS system with vert 120 mounting set

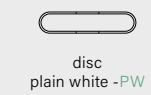
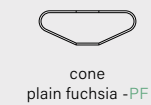

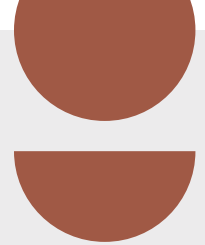

The BEADS concept was developed in collaboration with Maciej Ferenc as an original idea refined together with our R&D team. BEADS combines market technical standards with the Polish glassmaking tradition, offering a durable and flexible system solution that allows free configuration of distinctive decorative luminaires.

BEADS horiz mounting set suspended

length	cat. n°
120mm	59988-_-
200mm	59989-_-

power supply included

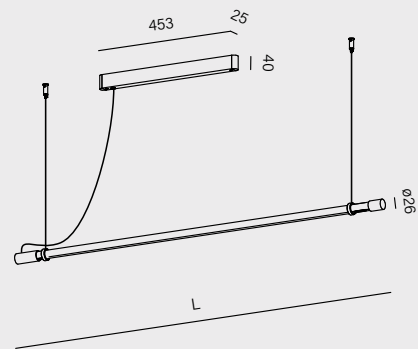

BEADS horiz mounting set SR suspended

length	cat. n°
120mm	59990-_-
200mm	59991-_-

power supply required

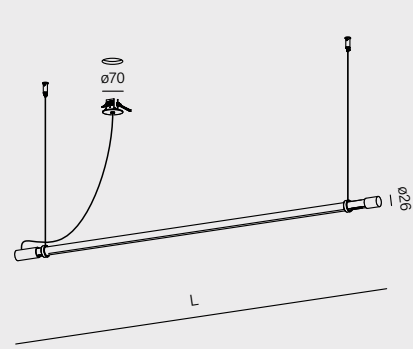

power supplies for SR version

cat. n°	name + dimensions
M00001000	MULTITRACK 48V power supply 100W 298mm x 30mm x 16.5mm ⌀ 50mm Hmin: 170mm
M00000600	MULTITRACK 48V power supply 60W 180mm x 45mm x 27mm ⌀ 50mm Hmin: 190mm
M00D11200	MULTITRACK 48V DIN power supply 120W 152.5mm x 40mm x 113.5mm

BEADS vert mounting set suspended

length	cat. n°
120mm	59960-_-

power supply included

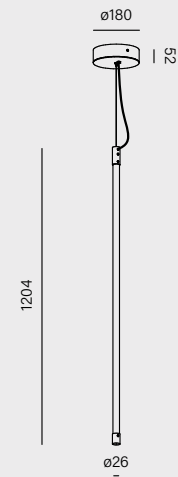

DECORATIVE LIGHTING INSTALLATIONS BASED ON GLASS SHADES AND FREEDOM OF CHOICE

**BEADS LED microtrack
ball | cone | disc**

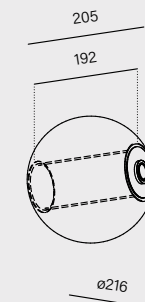

cat. n°
16527-M930-PW-00-12

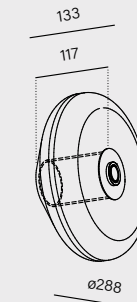

cat. n°
16528-M930-PW-00-12

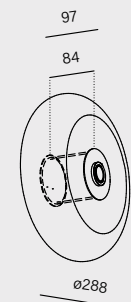

cat. n°
16529-M930-PW-00-12

	16527-M930-PW-00-12	16528-M930-PW-00-12	16529-M930-PW-00-12
power:	14W (M)	10W (M)	7W (M)
flux:	2019lm	1429lm	970lm
CCT:	2700K (27) 3000K (30) 4000K (40)		
control:	ON/OFF (00) DALI (DA)		



lampshade finishes

- plain white -PW ○
- plain graphite -PJ ●
- plain fuchsia -PF ●
- plain indygo -PI ●

luminaire finishes

- black -12 ●

main material

aluminium | glass | PMMA



OPTIMA

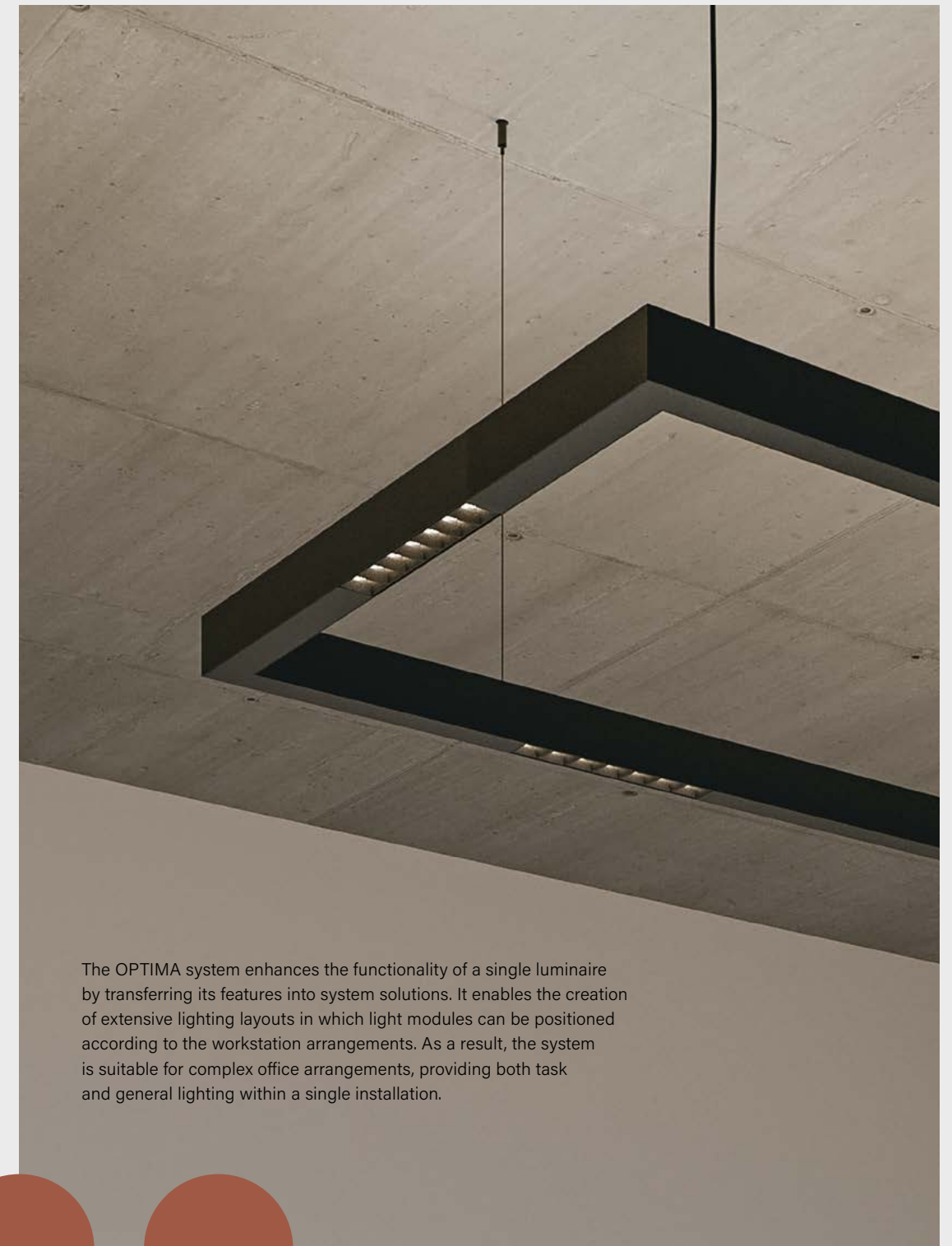

The OPTIMA system enhances the functionality of a single luminaire by transferring its features into system solutions. It enables the creation of extensive lighting layouts in which light modules can be positioned according to the workstation arrangements. As a result, the system is suitable for complex office arrangements, providing both task and general lighting within a single installation.

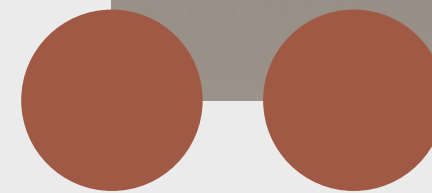

HOW TO USE SYSTEM

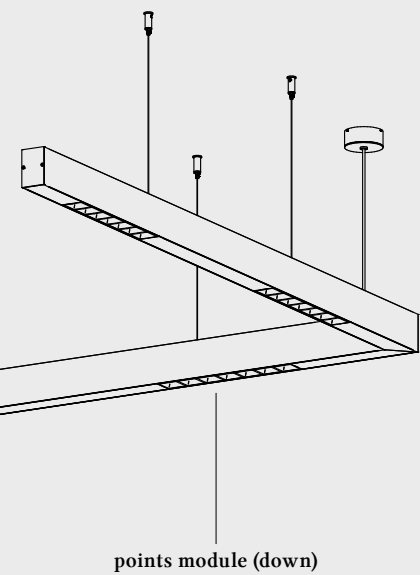
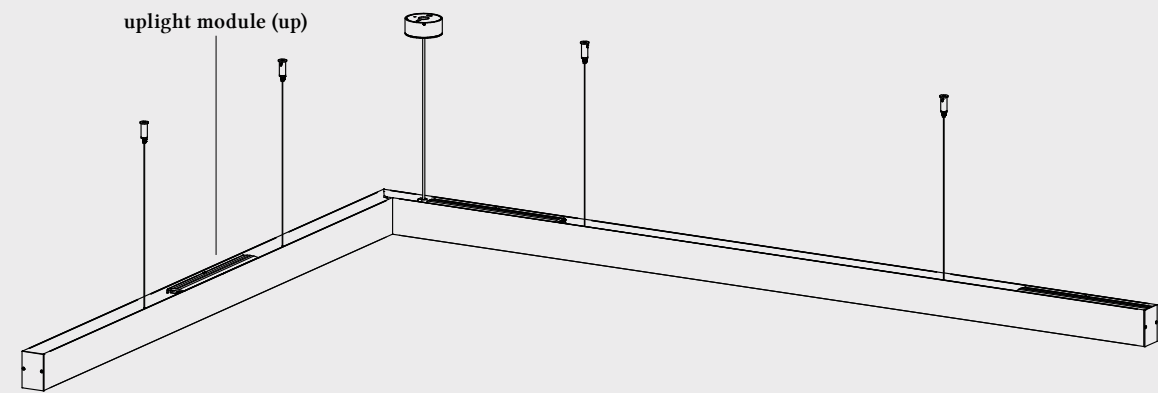

Plan the system layout
Specify the number of modules
Select the system finish (white, black or brutal) and optics (white or black)
Define parameters: colour temperature and control type



OPTIMA system LED suspended

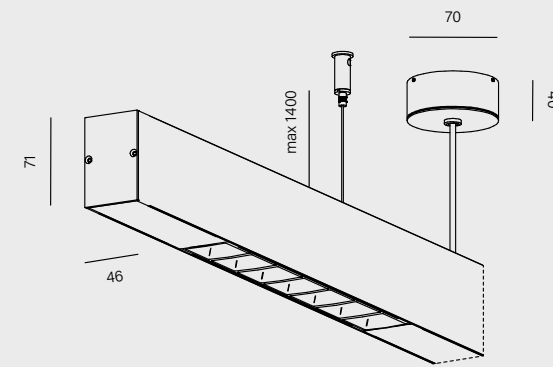

power:	(up): 10W (M) (down): 10.5W (M)
flux:	(up): 1389lm (down): 1295lm
optics:	(down): 73° (W)
CCT:	3000K (30) 4000K (40)
control:	ON/OFF (00) switchDIM (SW) DALI (DA) Aqsmart (DB)



optics detail

black -_B-

white -_W-



optics finishes

white -_W- ○
black -_B- ●

luminaire finishes

white -13 ○
black -12 ●
brutal -85 ●

main material
aluminium | PC

SPIDER SYSTEM

SPIDER systems, available in wall-mounted and suspended versions, use a single power point to create individual compositions based on freely routed cables. Different AQForm luminaires can be combined, making it easy to design distinctive layouts wherever a project requires flexibility and a unique decorative form.

PET mini LED spider suspended



MIX
MATCH
ARRANGE
EXPAND

MAXI RING dot LED suspended | MODERN GLASS tube LED spider suspended



Mojo Lounge, Zielona Góra

Design: FANALHO Home Design Decor | Photo: Krzysztof Strzyński STUDIO

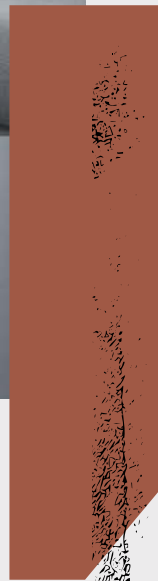

HOW TO USE SYSTEM

Combining standard components into non-standard configurations is the core idea behind systems. Modules with covers, spotlights and reflectors, as well as non-luminous and power-supply elements, can be arranged into sets of 2 to 8 luminaires. Suspended and surface-mounted versions, along with wall lamps, work with power supply boxes in various shapes and connection capacities. All elements and their configuration possibilities are presented on the following pages.

1. Choose luminaire module

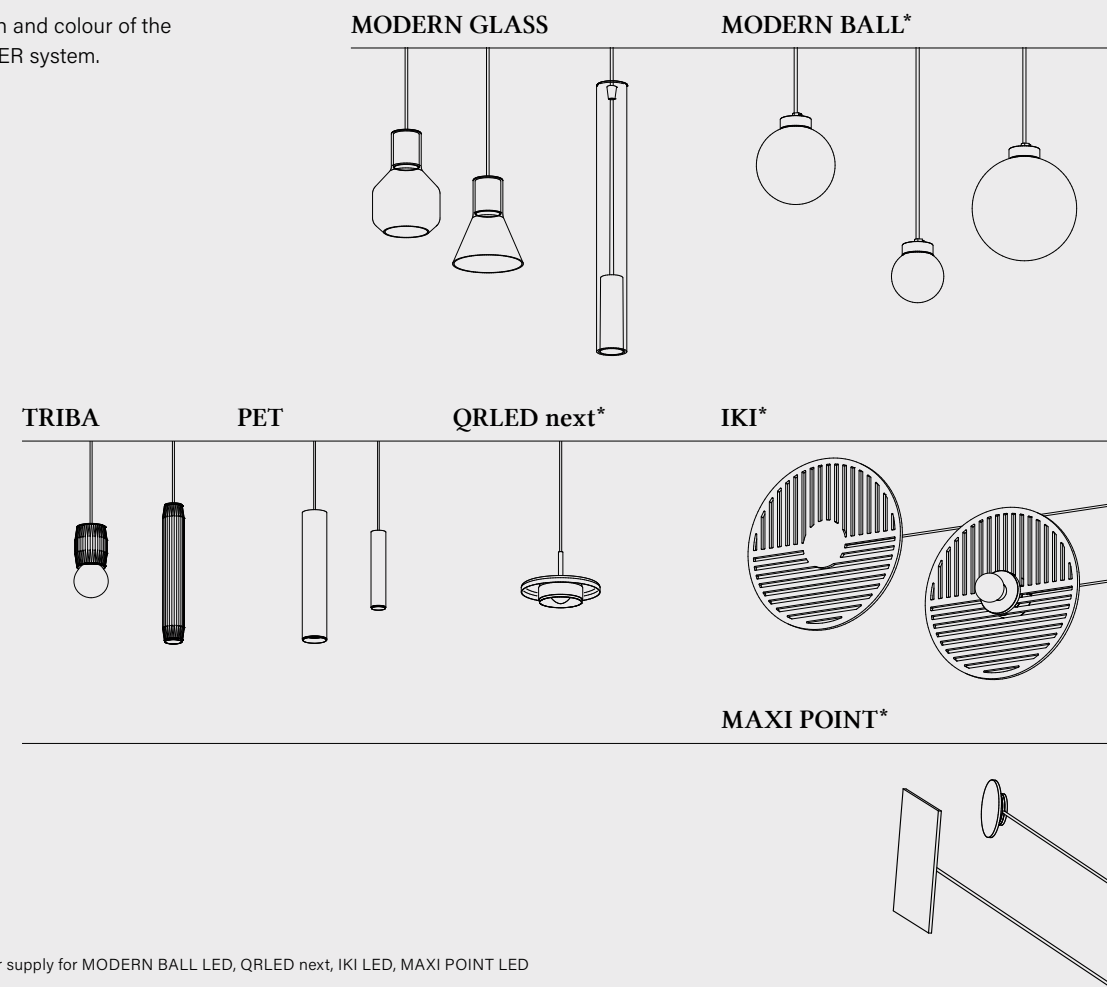

Select the shape, finish and colour of the luminaire for the SPIDER system.



* Requires the use of a power supply for MODERN BALL LED, QRLED next, IKI LED, MAXI POINT LED
Full list of luminaires is available on the next page.

2. Choose lamp canopy

Choose the size, colour and finish of the lamp canopy. More holes or non-standard arrangements are possible. Remember that more than one lamp canopy can be joined together. For versions of x6, x7 and x8 – check out our website.

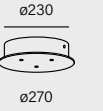
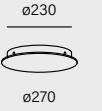
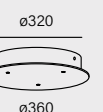
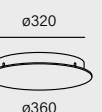
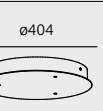
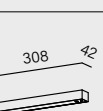
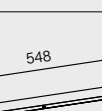
		x2 2 holes	x2 side 2 holes side	x3 3 holes	x3 side 3 holes side	x4 4 holes	x4 side 4 holes side	x5 5 holes	x5 side 5 holes side
	34  ø90 canopy round 9 side				50590-__				
	34  ø120 canopy round 12 side								50467-__
62  ø270 canopy round 27	42  ø270 canopy round 27 side	51489-__	51483-__	50469-__	51502-__	51490-__	51484-__	51491-__	51485-__
62  ø360 canopy round 36	42  ø360 canopy round 36 side	51477-__	51495-__	51469-__	51496-__	51478-__	51497-__	51479-__	51498-__
62  ø440 canopy round 44		51471-__		51470-__		51472-__		51473-__	
32  canopy bar 31x2	32  canopy bar 55x2	51000-__		51001-__					

3. Choose ceiling fixing

Select the colour, finish and number of ceiling fixing needed.

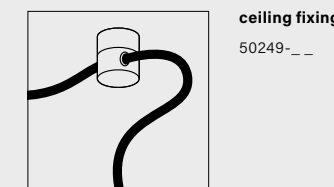

4. Define cables

Choose the colour of the cable, then select the number of wires needed. The standard cable length per a SPIDER module is 1400mm. Longer on request.

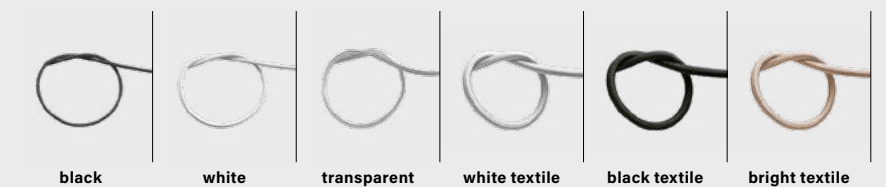

MODERN GLASS spider suspended
LED | GU10 | E27

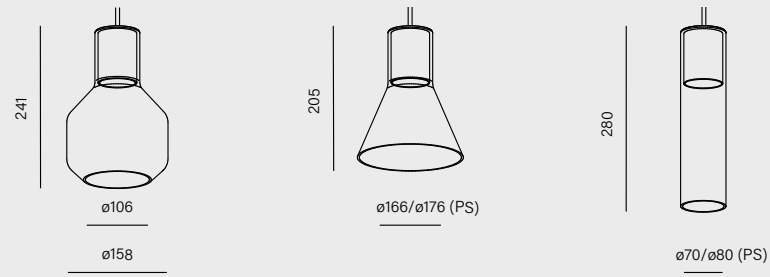

lampshade	cat. n°	cat. n°	cat. n°
barrel	58853-M930-PP-00-12	58563-G000-PP-PH-12	54566-E000-PP-PH-12
flared	59981-M930-PP-00-12	59979-G000-PP-PH-12	59977-E000-PP-PH-12
tube	59970-M930-PP-00-12	59974-G000-PP-PH-12	59971-E000-PP-PH-12
power:	8.5W (M)		max: 50W
flux:	1149lm		-
optics:	Plain Transparent (PP) Plain Karo (PK) Plain Strip (PS)* Plain White (PW)		
CCT:	2700K (27) 3000K (30) 4000K (40)		-
control:	ON/OFF (00) Phase-Control (PH)		Phase-Control (PH)

for GU10 and E27 light source not included | * only for Flared and Tube

main material: aluminium | glass

MODERN GLASS mini LED
spider suspended

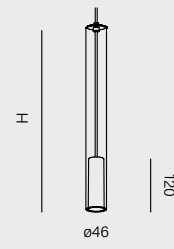

height	cat. n°
280mm	59892-M930-WB-00-12
420mm	59893-M930-WB-00-12
700mm	59894-M930-WB-00-12
power:	4.5W (M)
flux:	543lm
optics:	20° (S) 41° (W)
CCT:	2700K (27) 3000K (30) 4000K (40)
control:	ON/OFF (00)

main material: aluminium | glass

IKI spider wall
LED | E27

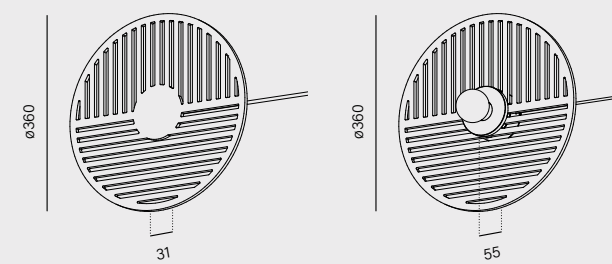

	cat. n°	cat. n°
	26564-A930-D9-CC-A2	26562-E000-00-PH-A2
power:	4.5W (A)	max: 15W
flux:	543lm	-
CCT:	2700K (27) 3000K (30) 4000K (40)	-
CC driver:	(B) 500mA 8.6V	-
control:	-	Phase-Control (PH)

for E27 light source not included
control dependent on driver

main material: MDF | steel | aluminium

MAXI POINT LED spider wall
round | square

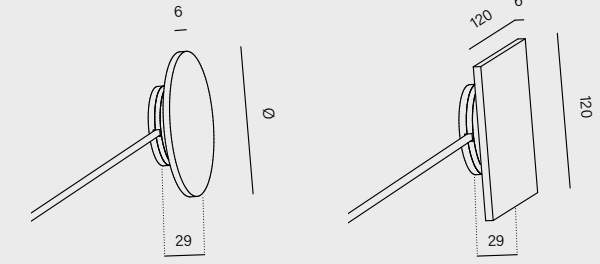

diameter	cat. n°	length	cat. n°
ø80mm	26553-A930-D9-CC-12	120x120mm	26516-A930-D9-CC-12
ø128mm	26513-A930-D9-CC-12		
ø210mm	26610-A930-D9-CC-12		
power:	4.5W (A)		
flux:	543lm		
CCT:	2700K (27) 3000K (30) 4000K (40)		
CC driver:	(B) 500mA 8.6V		

control dependent on driver

main material: aluminium | PMMA

MODERN BALL simple PW LED spider suspended
mini | midi | maxi

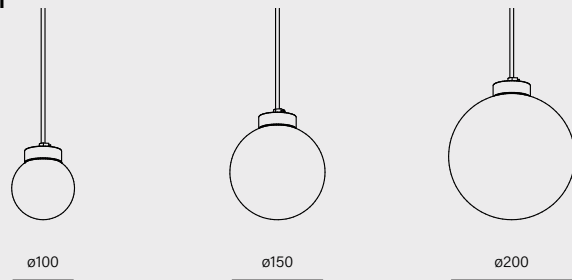

	cat. n°	cat. n°	cat. n°
	59901-A930-PW-CC-12	59837-A930-PW-CC-12	59902-A930-PW-CC-12
power:	6W (A)	9W (A)	11.5W (A)
flux:	794lm	1134lm	1617lm
CCT:	2700K (27) 3000K (30) 4000K (40)		
CC driver:	(D) 350mA 16.7V	(G) 350mA 25.1V	(K) 350mA 32.8V

control dependent on driver

main material: aluminium | glass

PET LED spider suspended
mini | midi

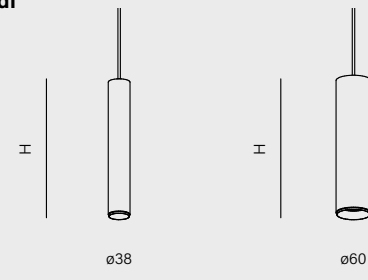

height	cat. n°	cat. n°
200mm	59820-M930-WB-00-12	59817-M930-WB-00-12
320mm	59821-M930-WB-00-12	59818-M930-WB-00-12
power:	4.5W (M)	8.5W (M)
flux:	543lm	1149lm
optics:	20° (S) 41° (W)	18° (S) 35° (F) 50° (W)
CCT:	2700K (27) 3000K (30) 4000K (40)	
control:	ON/OFF (00)	

main material: aluminium

TRIBA spider suspended
mini LED | midi LED | midi GU10 | midi E27

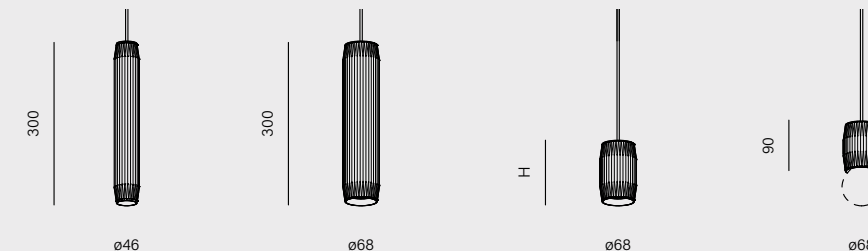

	cat. n°	cat. n°	height	cat. n°	cat. n°
	59929-M930-WB-00-12	59928-M930-WB-00-12	120mm	57669-G000-WB-PH-12	59927-E000-00-PH-12
			300mm	57668-G000-WB-PH-12	
power:	4.5W (M)	8.5W (M)	max: 50W		
flux:	543lm	1149lm	-		
optics:	20° (S) 41° (W)	18° (S) 35° (F) 50° (W)	-		
CCT:	2700K (27) 3000K (30) 4000K (40)		-		
control:	ON/OFF (00)	ON/OFF (00)	Phase-Control (PH)		
		Phase-Control (PH) DALI (DA)			

main material: aluminium

QRLED next spider
suspended

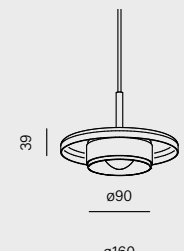

	cat. n°
	59930-A930-W3-CC-12
power:	9W (A)
flux:	1134lm
optics:	52° (W)
CCT:	2700K (27) 3000K (30) 4000K (40)
CC driver:	(G) 350mA 25.1V

main material: aluminium | optical glass | PPE+PA
control dependent on driver

SPIDER



luminaire finishes - only for IKI

- black&graphite panel -G2
- black&ash panel -A2
- black&orange panel -O2

ring finishes - only for PET and TRIBA LED

- white -_W
- black -_B
- natural -_N
- burgundy -_U
- terracotta -_R
- sandy -_D
- taupe -_T
- grey -_A
- gold -_G

luminaire finishes

- white -13
- black -12
- brutal -85
- burgundy -86
- terracotta -83
- sandy -87
- taupe -82
- grey -84
- gold -19

PIPER_

The PIPER system is based on linear modules connected with flexible connectors, allowing individual and extensive lighting compositions to be created. The solution uses a single power source and enables layouts to run in multiple directions and planes. As a result, a high degree of freedom in shaping the lighting is achieved, making the system suitable wherever maximum design flexibility is required.

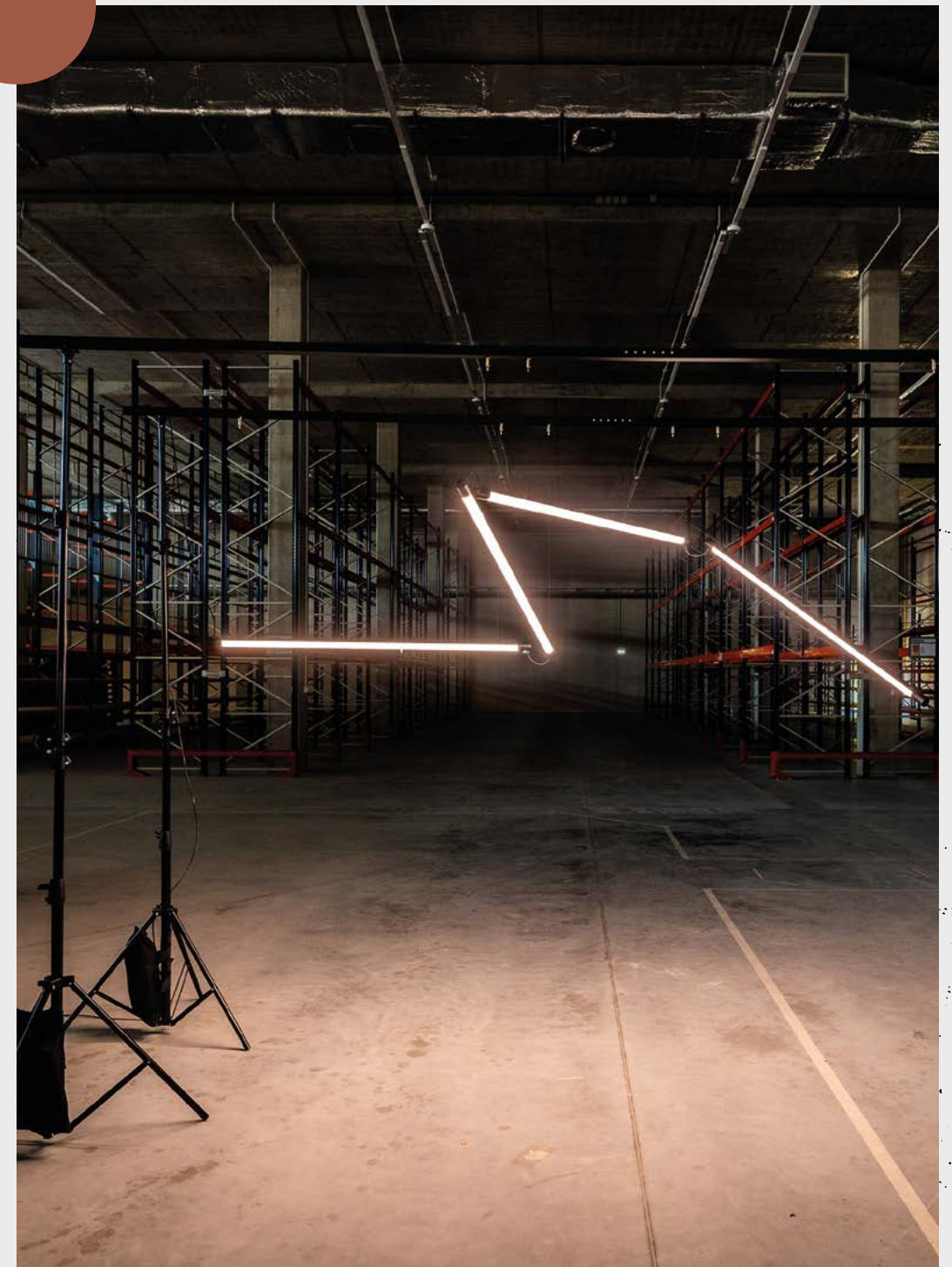
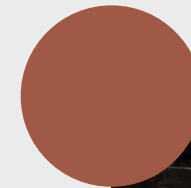

HOW TO USE SYSTEM



flexible connector

- Plan a layout consisting of up to 15 modules
- Choose the length of each module: 130 or 150 cm
 - Select the length of flexible connectors: 15 or 100 cm
 - Adjust the suspension length
 - Finish the layout with a power end cap with cable and an end cap.

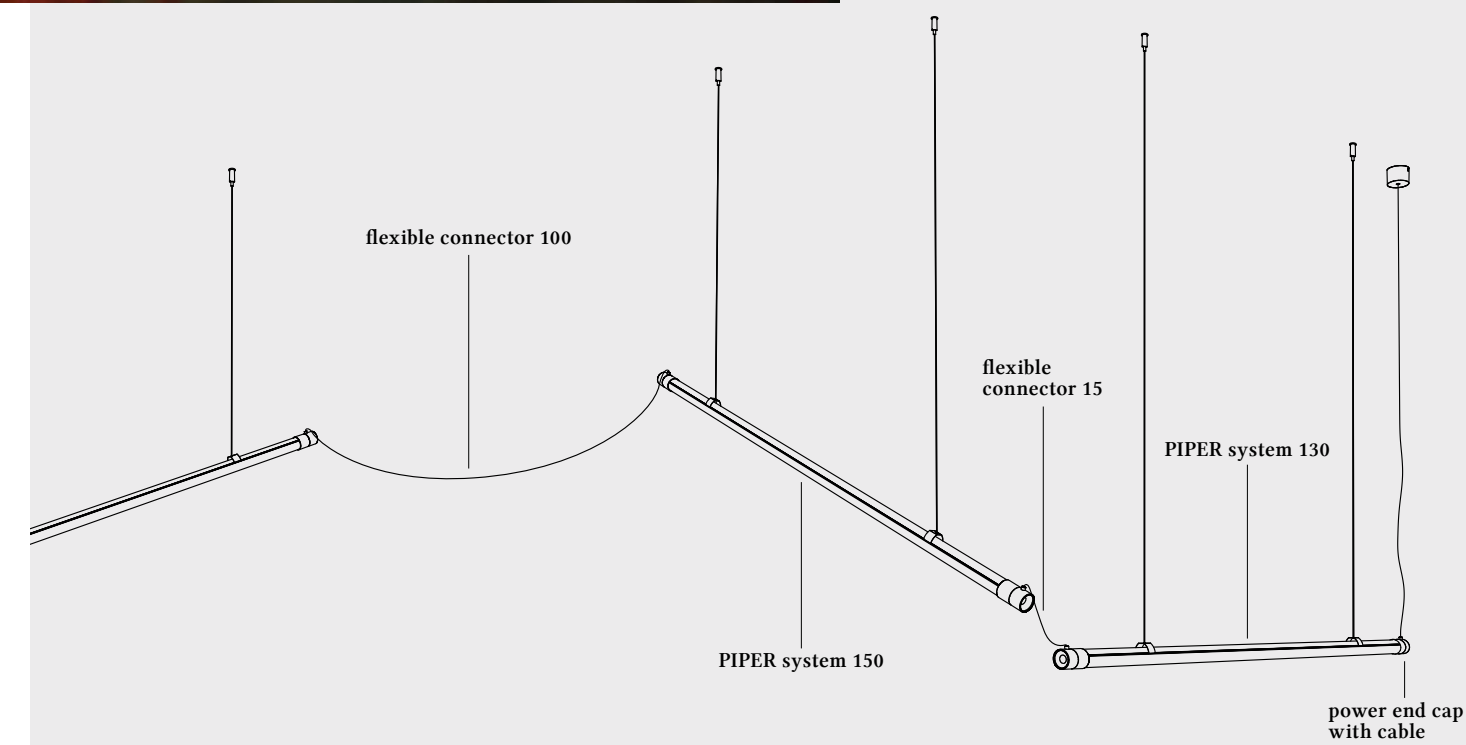

accessory	cat. n°
end cap:	71267
flexible connector 15:	71268
flexible connector 100:	71269
power end cap with cable:	71266

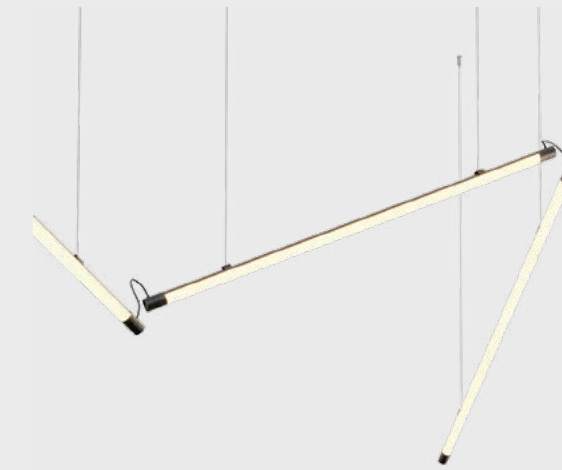

PIPER system LED 230V suspended

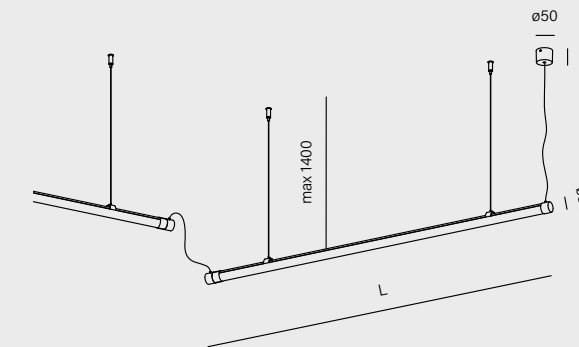

length	cat. n°
1300mm	71264-M942-D9-PH-12
1500mm	71265-M942-D9-PH-12
power:	23.5W - 26.5W (M)
flux:	2970lm - 3077lm
CCT:	adjustable 2700K, 3000K, 4000K (42)*
control:	Phase-Control (PH)



*Possibility to change the colour temperature using integrated switch.

accessory

- 81263 - PIPER x4 mechanical connector
- 81262 - PIPER x4 electrical connector



www.aqform.com

luminaire finishes

black -12 ●

main material
aluminium | PC

PET_rift

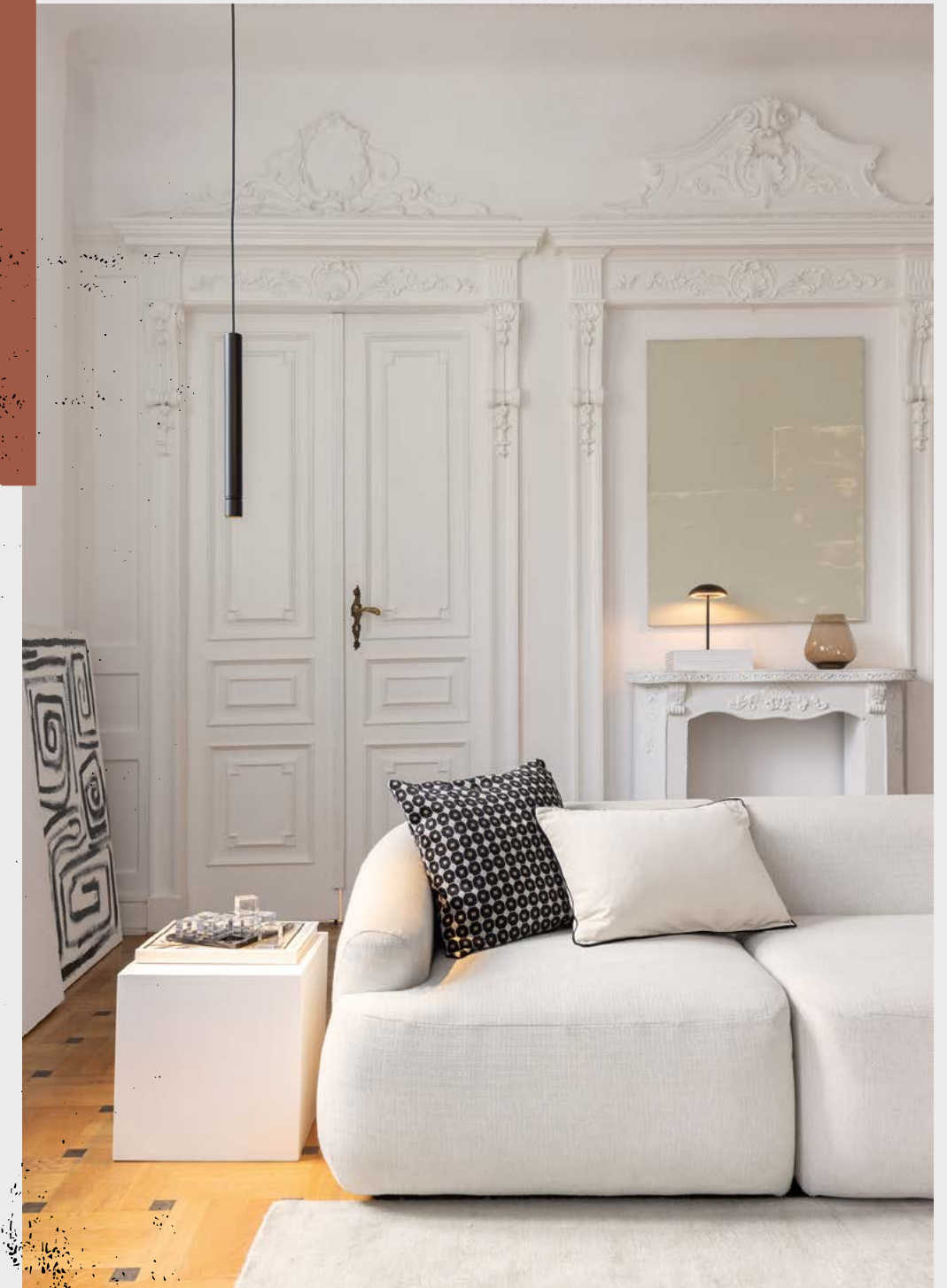



The PET rift system is based on PET mini and PET midi luminaires, preserving their performance and light characteristics. The availability of suspended, surface-mounted and wall-mounted versions allows cohesive sets with a consistent lighting effect to be created. This solution supports stylistic continuity within a project while delivering precise illumination.

HOW TO USE SYSTEM

1. Define the assembly: surface, wall or suspended

2. Define the lighting module: light parameters and colour

- Choose the mounting version: suspended, surface-mounted or wall-mounted
- Specify the luminaire size: mini or midi
- Select the appropriate beam angle and colour temperature
- Set the luminaire body length from 20 to 100cm in 10cm increments.

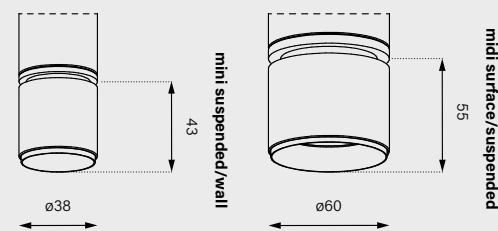

3. Define the housing: colour and length

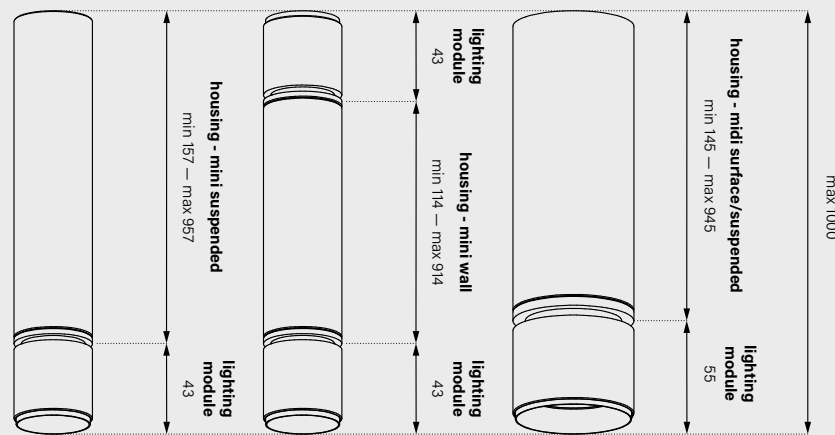

At this stage, a configuration is defined according to the function of the space. The body and the lighting module are ordered separately.

Choose the colour finishes for:

- the housing
- the optics
- the decorative ring

Colours can be freely combined to create a set aligned with the design concept and interior style.

4. Define the cable (only for suspended)

Finally, select one of the three available cable colours.

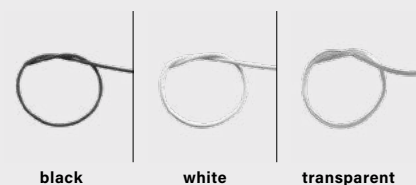

PET mini rift
suspended | wall up&down

PET midi rift
suspended | surface

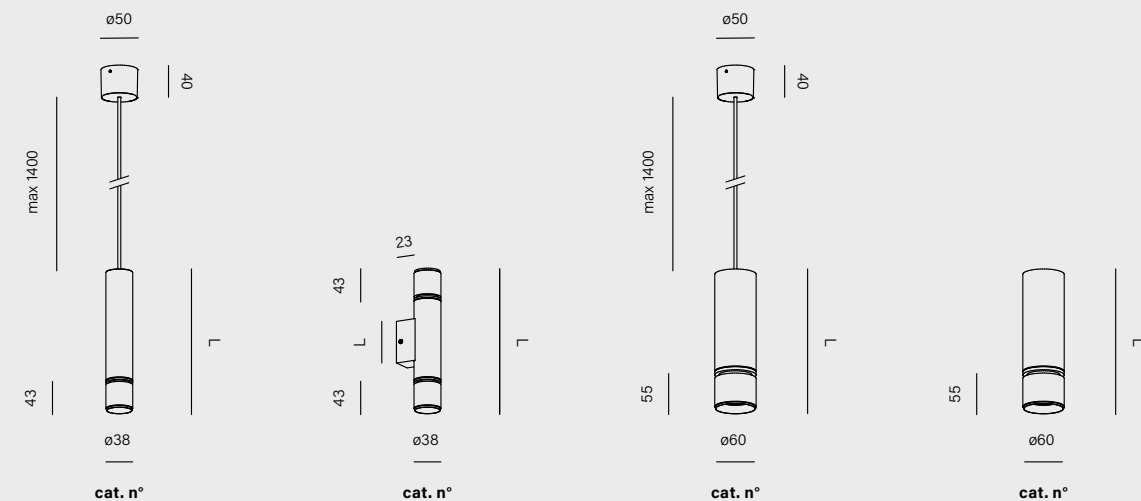

	cat. n°	cat. n°	cat. n°	cat. n°
lighting modules:	71243-M930-WB-00-12	71253-M930-WB-00-12	71270-M930-WB-00-12	71217-M930-WB-00-12
power:	4.5W (M)	6W (M)	8.5W (M)	
flux:	543lm	778lm	1149lm	
optics:	20° (S) 41° (W)		18° (S) 35° (F) 50° (W)	
CCT:	2700K (27) 3000K (30) 4000K (40)			
control:	ON/OFF (00)		ON/OFF (00) DALI (DA)	

- ring finishes**
- white -_W ○
 - black -_B ●
 - natural -_N ●
 - burgundy -_U ●
 - terracotta -_R ●
 - sandy -_D ●
 - taupe -_T ●
 - grey -_A ●
 - gold -_G ●
- luminaire finishes**
- white -13 ○
 - black -12 ●
 - brutal -85 ●
 - burgundy -86 ●
 - terracotta -83 ●
 - sandy -87 ●
 - taupe -82 ●
 - grey -84 ●
 - gold -19 ●

main material
aluminium



ALULINE

THINK
OUTSIDE
THE
BOX

The ALULINE system consists of linear LED luminaires in mini and midi versions, available as trim and trimless recessed as well as surface-mounted installations. The profile with an opal diffuser enables the creation of evenly illuminated lines in three lengths. Dedicated connectors allow the continuity of the luminaire run, including right-angle bends and transitions between ceiling and wall.



HOW TO USE SYSTEM

The ALULINE system can be ordered either as predefined luminaires or as individual components.

1. Complete system

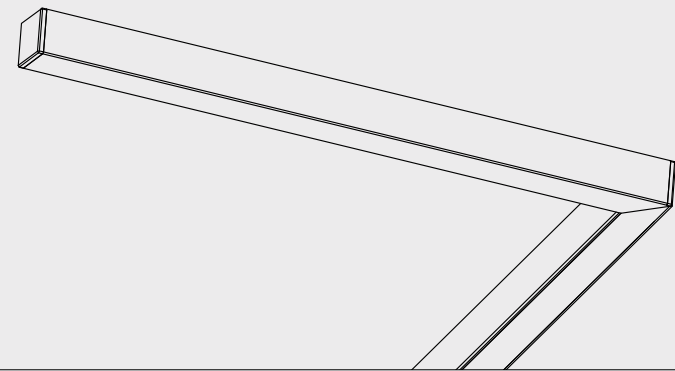

When choosing complete system sets, you receive a profile cut to a specified length with an end cap, an LED module and a power supply. Upon request, the order can also include a 90-degree corner connection.

2. Individual components can be ordered separately.

- Select the size and mounting version: mini recessed (with or without frame), mini surface-mounted or midi surface-mounted.
- Specify the number and length of profiles: 1000mm, 2000mm or 3000mm
- Select the colour finish.
- Choose the appropriate connectors: straight, 90° angle, or ceiling-to-wall.

The option to purchase an LED strip with a minimum length of 5 metres (reel).

More information can be found in the technical brochure.

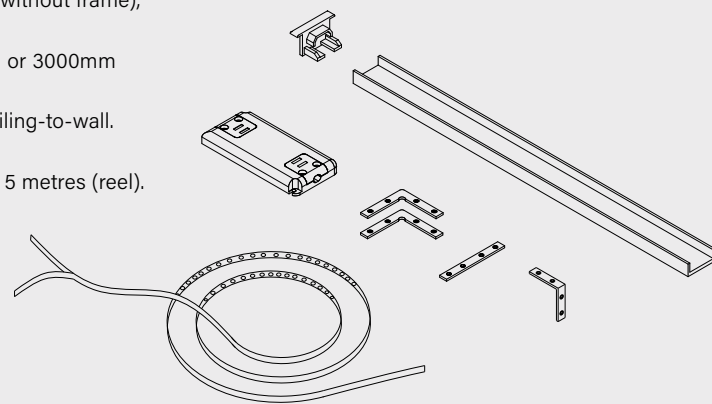

ALULINE LED (complete system)

mini trimless recessed | mini recessed | mini surface | midi surface

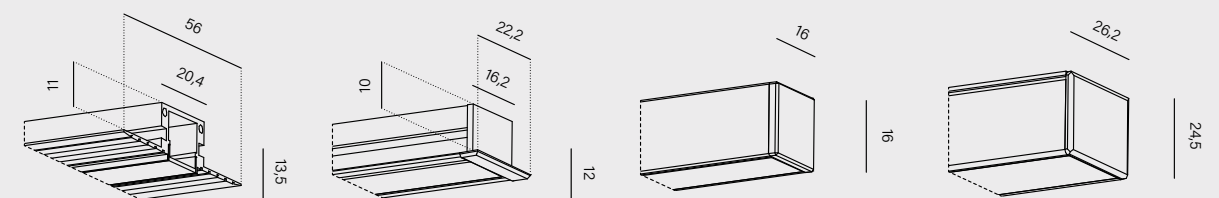

length	cat. n°	cat. n°	cat. n°	cat. n°
1000mm	70125-M930-D9-00-11	70124-M930-D9-00-70	70126-M930-D9-00-70	71216-M930-D9-00-12
2000mm	71238-M930-D9-00-11	71236-M930-D9-00-70	71240-M930-D9-00-70	71242-M930-D9-00-12
3000mm	71239-M930-D9-00-11	71237-M930-D9-00-70	71241-M930-D9-00-70	
power:	10W/m - 30W/m (M)			20W/m - 40W/m (M)
flux:	850lm/m			1700lm/m
optics:	opal (D9)			
CCT:	3000K (30) *			
control:	ON/OFF (00)			



*2700K and 4000K on request

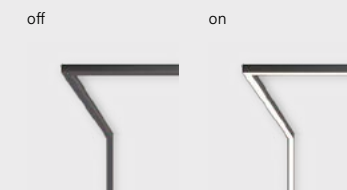

On request, you can order ALULINE with black cover. When turned ON, it shines evenly.



- | | |
|---|---|
| <p>luminaire finishes
only for mini recessed & mini surface</p> <ul style="list-style-type: none"> alu anodized -70 black anodized -72 | <p>luminaire finishes
only for midi surface</p> <ul style="list-style-type: none"> white -13 black -12 burgundy -86 terracotta -83 sandy -87 taupe -82 grey -84 gold -19 |
| <p>luminaire finishes
only for mini trimless recessed</p> <ul style="list-style-type: none"> natural aluminium -11 | |

main material
aluminium | PC

LEDLINE

LEDLINE is a recessed system that enables light to flow across ceiling and wall surfaces. Compact-height profiles can be connected in straight lines or at angles, creating simple or broken layouts, including ceiling-to-wall transitions. The opal diffuser ensures a uniform, soft and eye-friendly lighting effect.

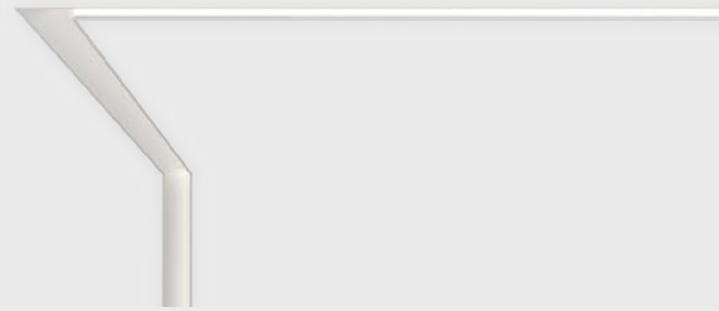

LEDLINE soft LED recessed

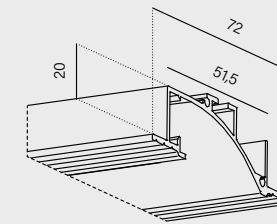

cat. n°	
	70129-M930-D9-00-13
power:	10W/m (M)
flux:	850lm/m
optics:	opal (D9)
CCT:	3000K (30) †
control:	ON/OFF (00)



†2700K and 4000K on request

- Plan the system layout
- Define the number of modules and their length
- Select the appropriate connectors: straight, 90° angle or ceiling-to-wall
- Enjoy a continuous line of light within the project.



www.aqform.com

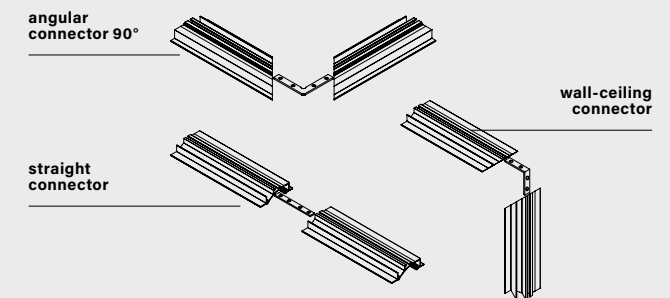

luminaire finishes

white -13 ○

main material
aluminium | PC

MIXLINE

MIXLINE is a linear system based on profiles available in recessed, surface-mounted and suspended versions. It consists of modules with lenses, an opal diffuser and PET spotlights, complemented by non-illuminated and power segments. Connectors allow both straight lines and angled layouts to be created, enabling easy adaption to project requirements.

MIXLINE LED system suspended | MODERN BALL maxi LED suspended

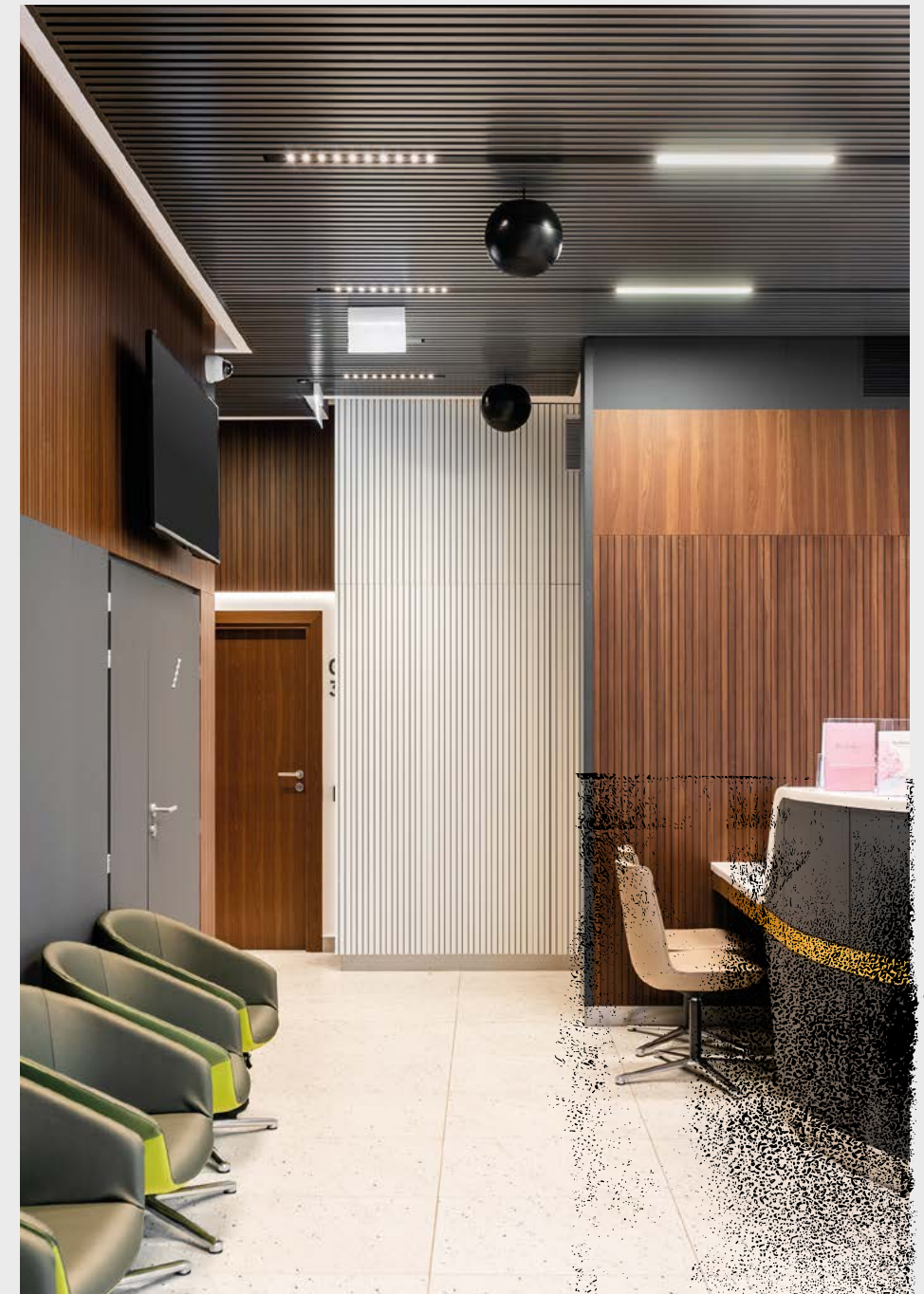

HOW TO USE SYSTEM

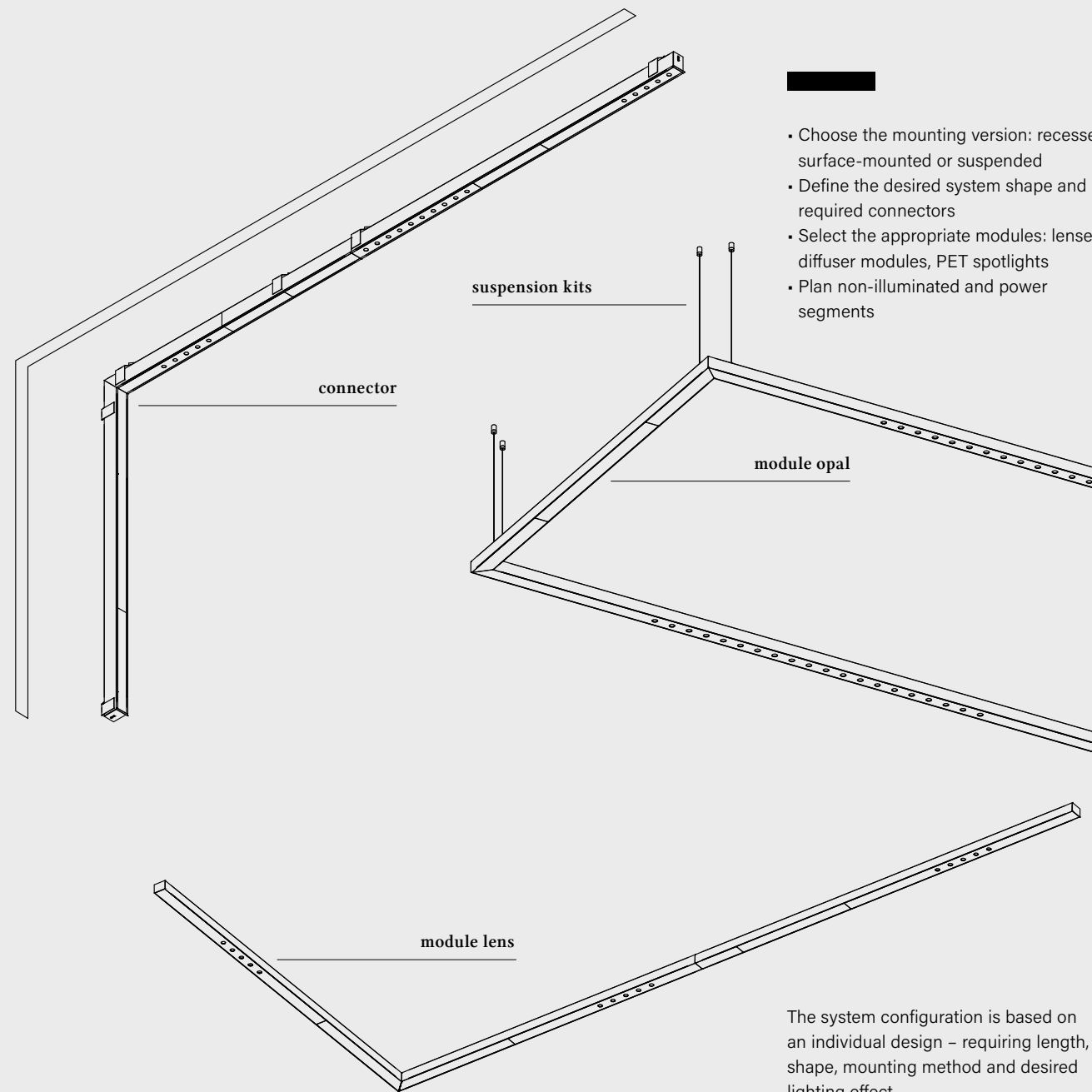

- Choose the mounting version: recessed, surface-mounted or suspended
- Define the desired system shape and required connectors
- Select the appropriate modules: lenses, diffuser modules, PET spotlights
- Plan non-illuminated and power segments

The system configuration is based on an individual design - requiring length, shape, mounting method and desired lighting effect.



recessed p. 098
surface p. 214
suspended p. 324
Systems

MIXLINE

CREATE WITHOUT BOUNDARIES

MIXLINE LED recessed | surface | suspended

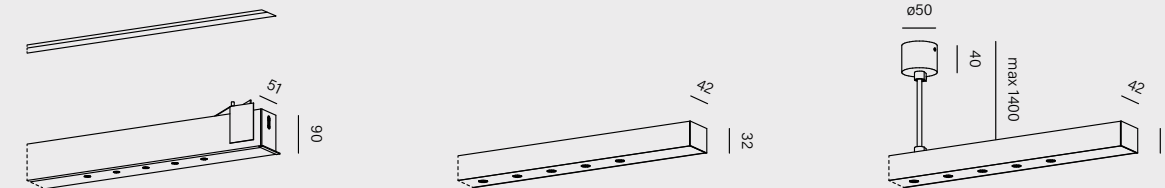

power:	diffuser (per 280mm): 8.5W (M) lens (per set of 5): 3.5W (M)
flux:	diffuser (per 280mm): 1160lm (M) lens (per set of 5): 450lm (M)
optics:	opal (D9) 26° (F) 54° (W)
CCT:	2700K (27) 3000K (30) 4000K (40)
control:	ON/OFF (00) switchDIM (SW) DALI (DA) Aqsmart (DB)

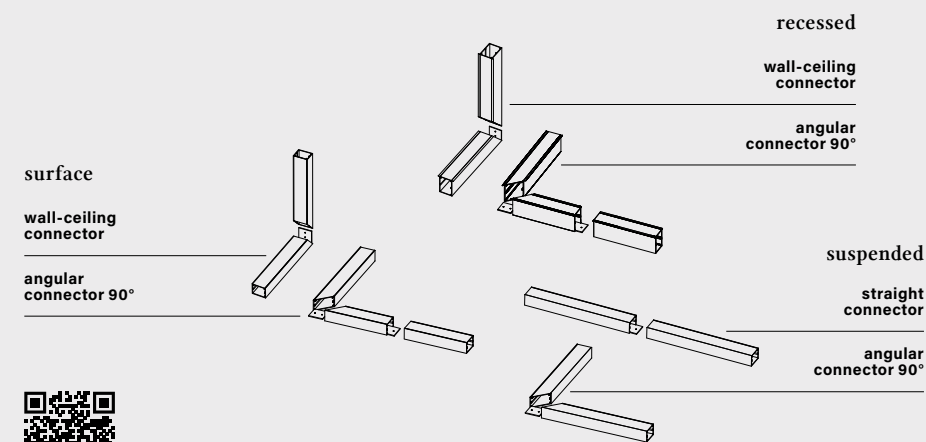

luminaire finishes
white -13 ○
black -12 ●
brutal -85 ●

main material
aluminium | PMMA



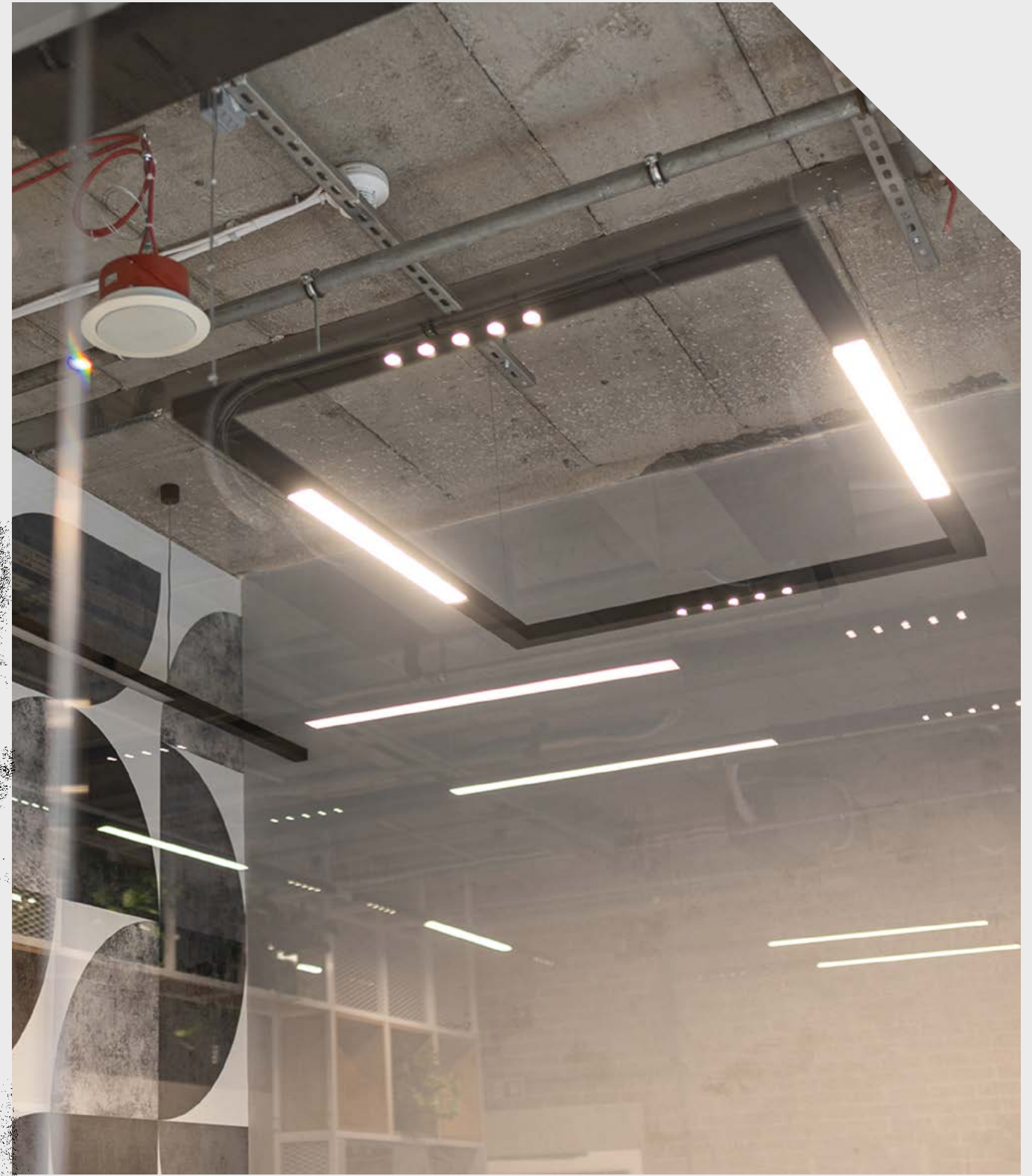

RAW mini

SET RAW mini is a recessed linear system with a lightweight design, enabling the creation of long, uniform light segments. Sections can be connected in straight lines or at right angles, adapting the layout to the architecture of the space. The system delivers soft, diffused light, making it ideal for corridors, circulation areas or as an additional accent in offices, hotels and private interiors.

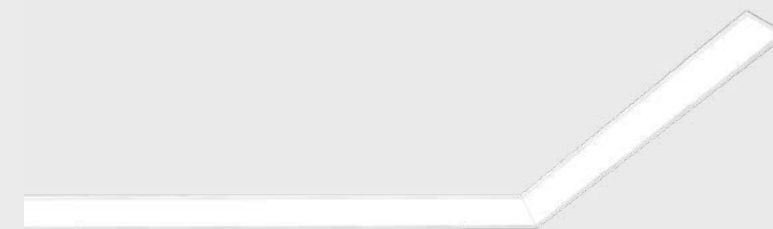

RAW mini LED recessed

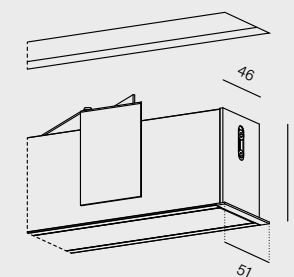

power:	(per 280mm): 4.5W (L) 8.5W (M)
flux:	(per 280mm): 582lm (L) 1164lm (M)
optics:	opal (D9)
CCT:	2700K (27) 3000K (30) 4000K (40)
control:	ON/OFF (00) switchDIM (SW) DALI (DA) Aqsmart (DB)



- Choose the length of the segments (min. 290mm, max. 2200mm) and their quantity
- Select connectors: straight, 90° angled or wall-to-ceiling.
- Define the desired lighting parameters
DONE!

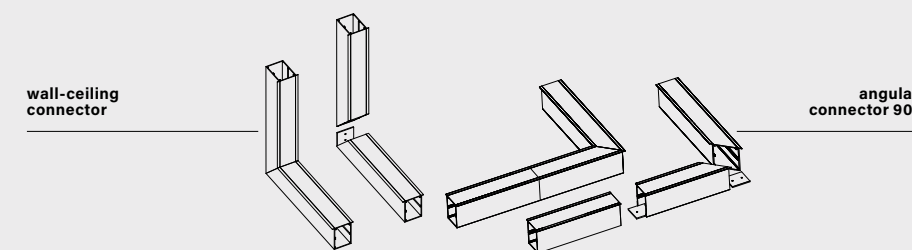

luminaire finishes

- white -13 ○
- black -12 ●
- brutal -85 ○
- burgundy -86 ●
- terracotta -83 ●
- sandy -87 ●
- taupe -82 ●
- grey -84 ●
- gold -19 ●

main material
aluminium | PMMA

TRU

TRU is a versatile linear system based on SET TRU luminaires, enabling the creation of extensive lighting structures. With multiple mounting options and four types of connectors, modules can be freely combined and the system adapted even to very spacious interiors without compromising functionality. The availability of two diffuser types, various power options, and Tunable White technology allows TRU to be precisely tailored to the space and user needs.



HOW TO USE SYSTEM

- Choose the mounting version: recessed (with or without frame), surface-mounted, wall-mounted or suspended (the last two also available in up & down versions)
- Select the diffuser: opal or microprismatic
- Define parameters: power and colour temperature
- Select the finish

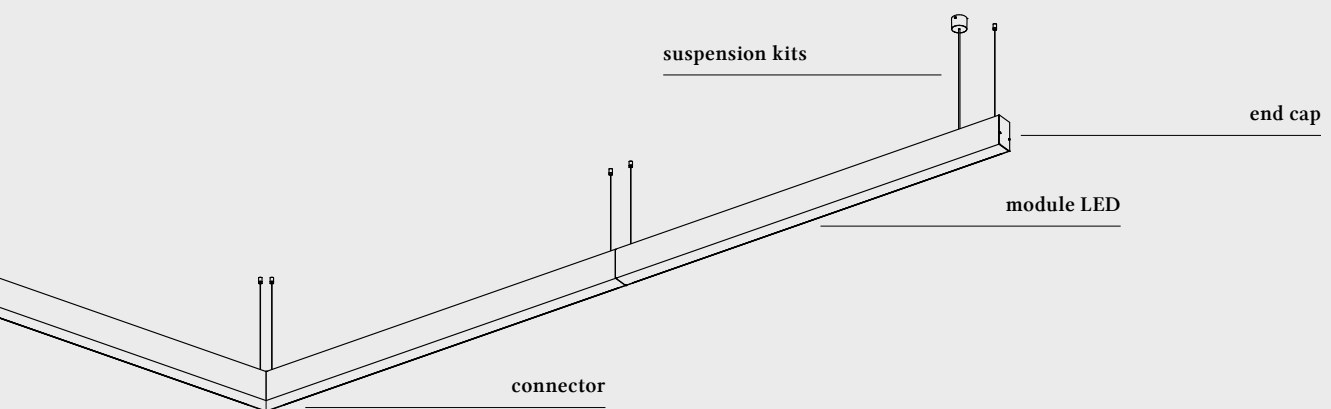

Select the appropriate connectors to create the desired layout.

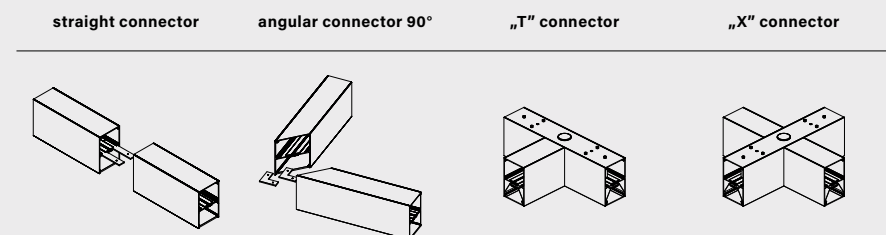

TRU
CREATE WITHOUT BOUNDARIES

recessed p. 122
surface p. 224
suspended p. 338
Track p. 442
wall p. 496
Systems

TRU LED up&down suspended

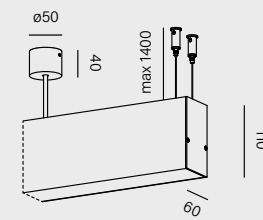

power:	(per 280mm): 8.5W (L) 17W (M)
flux:	(per 280mm): 1164lm (L) 2328lm (M)
optics:	opal (D9) microprism (D5)
CCT:	2700K (27) 3000K (30) 4000K (40)
control:	ON/OFF (00)



TRU LED trim recessed | recessed | surface | suspended | up&down suspended

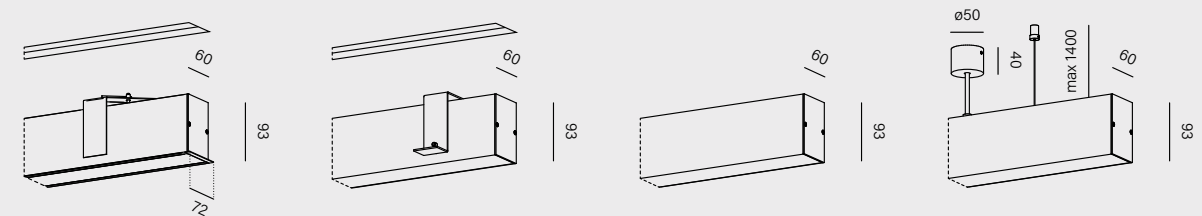

power:	(per 280mm): 4.5W (L) 8.5W (M)
flux:	(per 280mm): 582lm (L) 1164lm (M)
optics:	opal (D9) microprism (D5)
CCT:	2700K (27) 3000K (30) 4000K (40)
control:	ON/OFF (00)



the opal version (D9) has a Tunable-White option available

covers comparison

regular (opal) PRO (microprism)



luminaire finishes

- white -13
- black -12
- brutal -85
- burgundy -86
- terracotta -83
- sandy -87
- taupe -82
- grey -84
- gold -19

main material

aluminium | PMMA

RAFTER mix



RAFTER mix is an advanced system based on RAFTER luminaires, designed for interiors that require multiple layers of light within a single, visually cohesive arrangement. Its foundation consists of straight profiles, which can be connected at right angles and are available in recessed, surface-mounted and suspended versions. Within the system, LED modules with an opal diffuser can be used to provide uniform general lighting, points modules with lenses to deliver precise, low-glare task lighting and PET mini or midi spotlights to highlight selected elements. Various power options and control possibilities allow lighting parameters to be adjusted to the function of the space, from offices and circulation areas to meeting rooms and work zones.

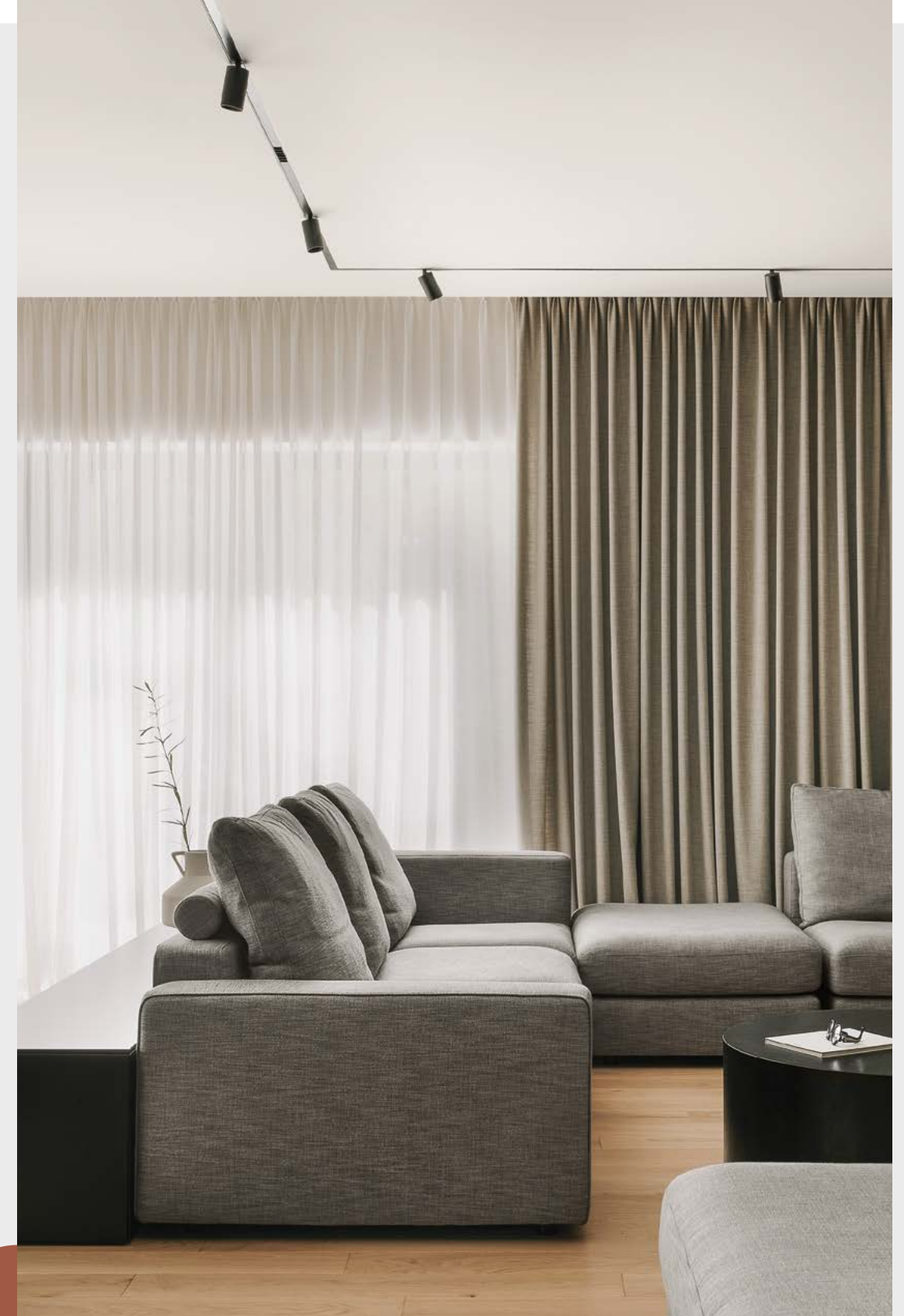

HOW TO USE SYSTEM

RAFTER
Systems
recessed p. 104-114
surface p. 206-212
suspended p. 328-330
Track p. 430-438
wall p. 494

CREATE WITHOUT BOUNDARIES

RAFTER mix recessed | surface | suspended

- Choose the mounting type: recessed, surface-mounted or suspended
- Plan the profile layout and segment lengths
- Configure the modules: LED with diffuser, points with lenses, PET mini/midi
- Add non-illuminated and power segments to match the system length

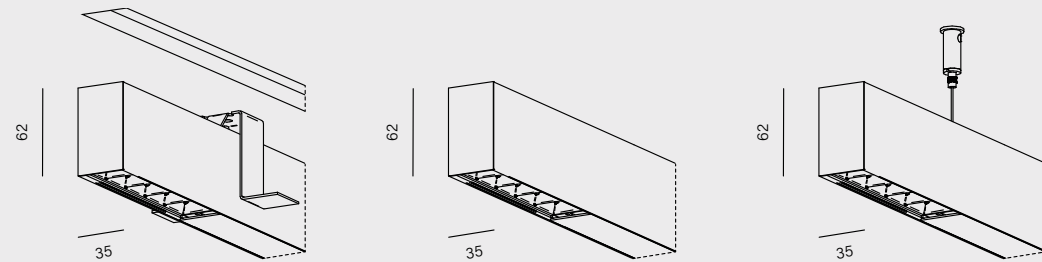

RAFTER LED (module)

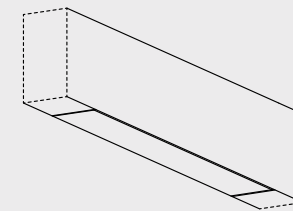

RAFTER points LED (module)

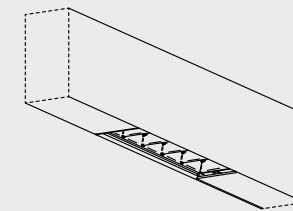

RAFTER PET LED (module) mini | midi

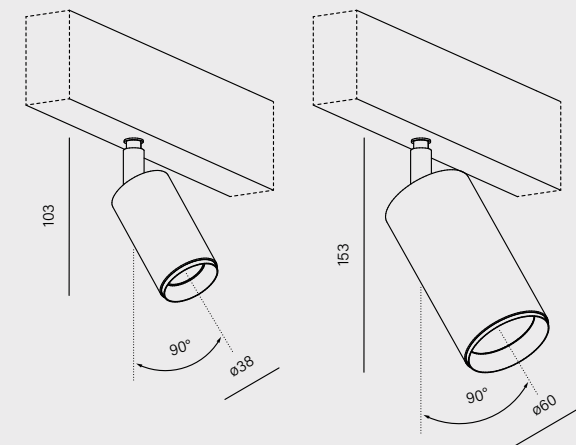

power:	diffuser (per 280mm): 4.5W (L) 8.5W (M)	3.5W (L) 7.5W (M)	4.5W (M)	8.5W (M)
flux:	diffuser (per 280mm): 540lm (L) 1080lm (M)	440lm (L) 780lm (M)	540lm	1140lm
optics:	opal (D9)	35° (F) 50° (W)	20° (S) 41° (W)	18° (S) 35° (F) 50° (W)
CCT:	2700K (27) 3000K (30) 4000K (40)			
control:	ON/OFF (00) switchDIM (SW) DALI (DA) Aqsmart (DB)			



*for RAFTER points module and RAFTER PET module

luminaire finishes

- white -13 ○
- black -12 ●
- brutal -85 ●
- burgundy -86 ●
- terracotta -83 ●
- sandy -87 ●
- taupe -82 ●
- grey -84 ●
- gold -19 ●

main material

aluminium | PC (points modules) | PMMA (opal)



Arrange the modules according to each zone's function: LED for general lighting, points for task lighting, PET for accenting elements.

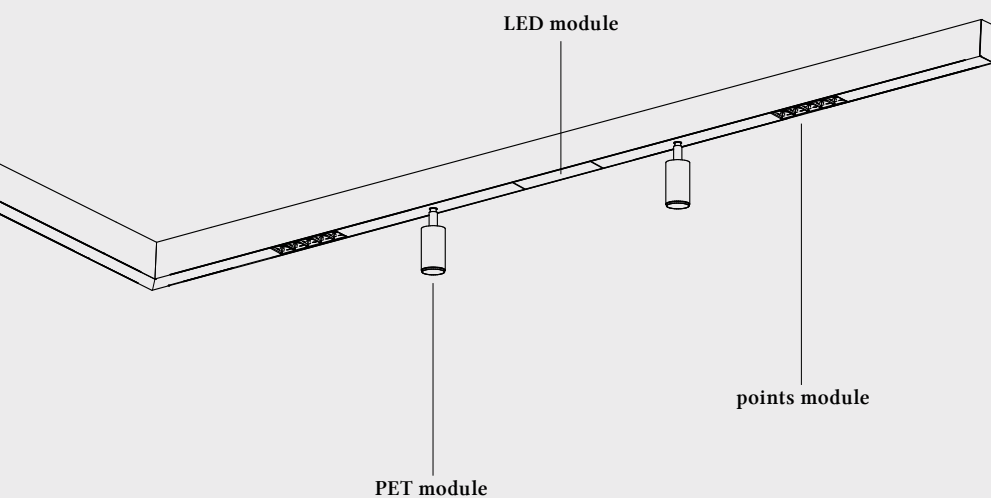



CUSTOM MADE

Custom systems are developed in collaboration with architects and investors when a project requires solutions beyond the standard offering. Thanks to the expertise of our design team, R&D facilities and in-house production, we create lighting systems tailored to a specific vision, whether based on existing components or as entirely new constructions designed from the ground up.

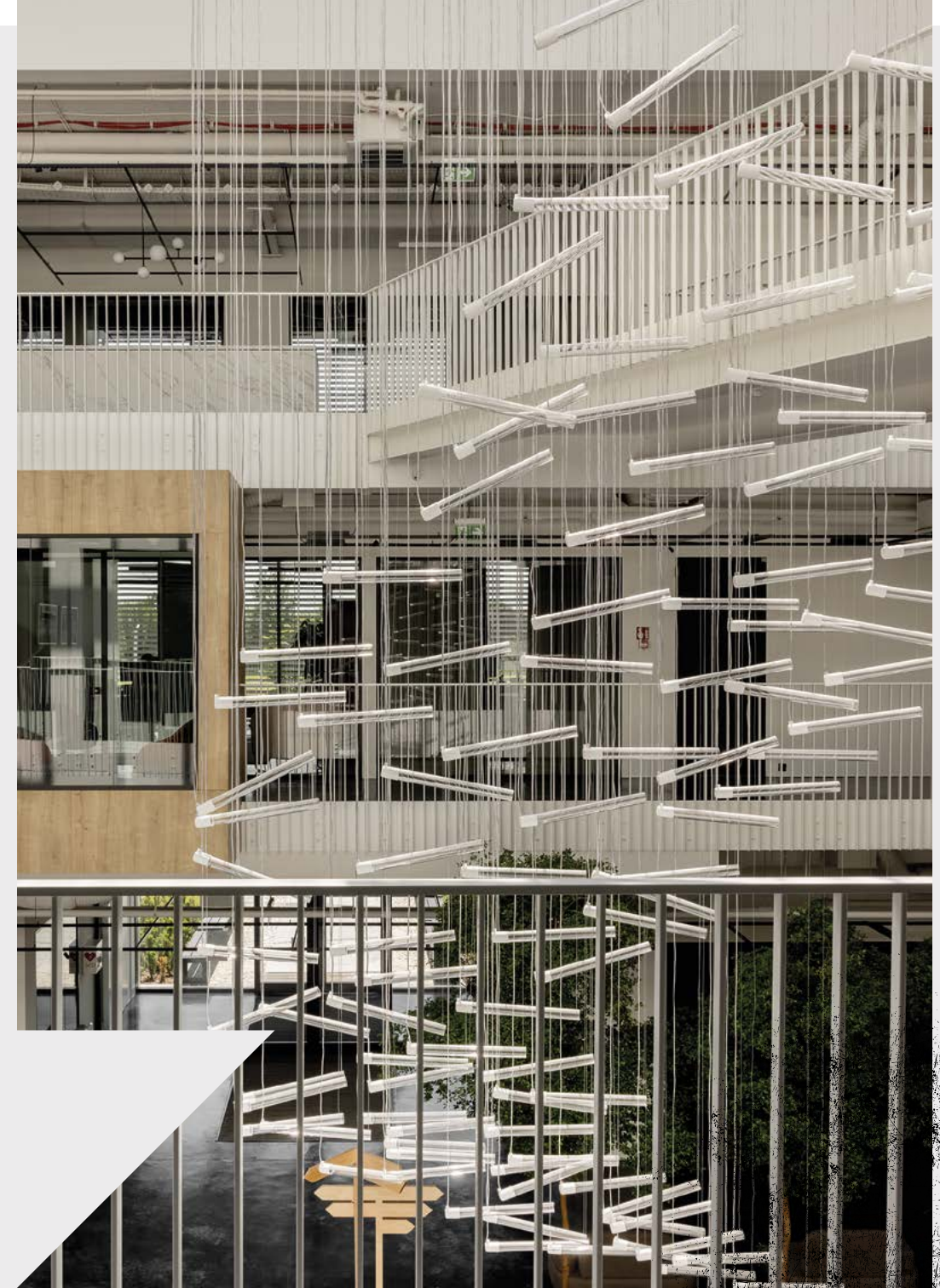



A DISTINCTIVE FINISH
CRAFTED EXCLUSIVELY
FOR THIS SPACE



CONA luminaires were finished in a custom-selected, bold colour that ties in with other interior elements, creating a cohesive design accent. The client chose a distinctive installation on metal tubes, perfectly complementing the industrial character of the concept. The rhythmic arrangement above the bar and tables delivers lighting that is both pleasant and visually striking.



The custom configuration of PET midi luminaires was based on curved structural elements inspired by FLYING BALL arc, creating a dynamic, arched composition above the restaurant area. The use of additional honeycomb diffusers ensured comfortable, precisely directed light without excessive glare.

A UNIQUE
INTERPRETATION
OF THE PET FAMILY
IN A NON-STANDARD VERSION

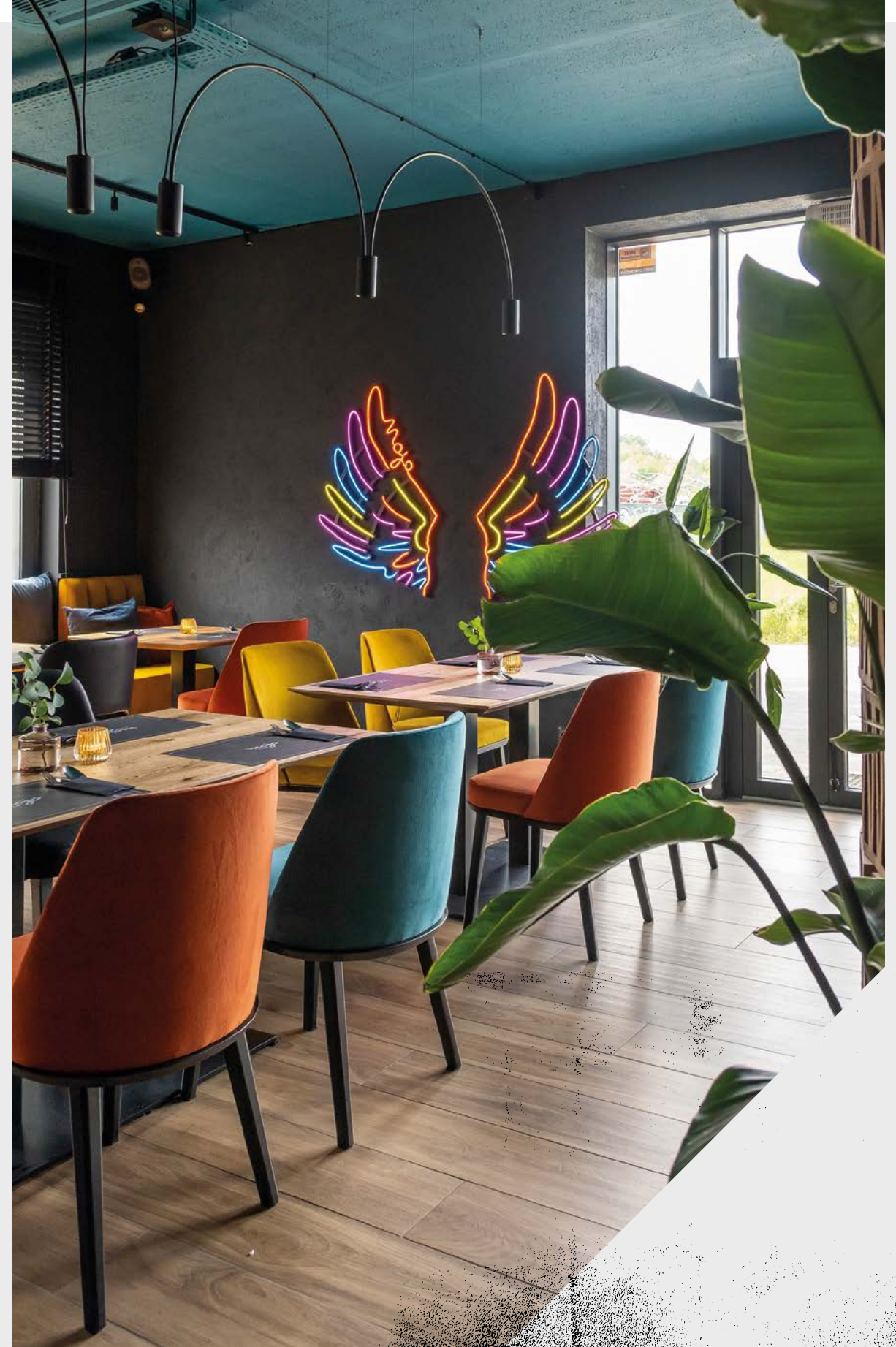

OUTRO

—

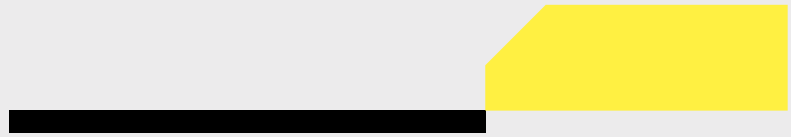

ESSENTIAL
INFORMATION

—

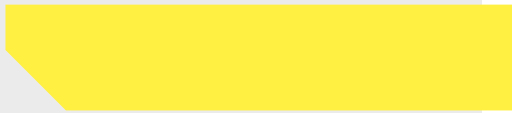

INDEX

by name

A

ALULINE mini LED multitrack	new	p. 428
ALULINE mini points LED multitrack	new	p. 428

B

BEADS ball LED suspended	new	p. 240
BEADS cone LED suspended	new	p. 240
BEADS cumulus LED suspended	new	p. 240
BEADS disc LED suspended	new	p. 240
BEADS horiz line 120 LED suspended	new	p. 236
BEADS horiz line 200 LED suspended	new	p. 236
BEADS ovo LED suspended	new	p. 240
BEADS vert line 120 LED suspended	new	p. 236
BIG SIZE next round LED suspended		p. 314
BIG SIZE next round LED surface		p. 202
BIG SIZE next round LED recessed		p. 100
BIG SIZE PRO next round LED suspended		p. 314
BIG SIZE PRO next round LED surface		p. 202
BIG SIZE PRO next round LED recessed		p. 100
BLOS cast C LED surface		p. 194
BLOS round distance LED hermetic surface		p. 198
BLOS round LED track		p. 446
BLOS round LED suspended		p. 312
BLOS round LED suspended track		p. 446
BUCLO chain LED suspended	new	p. 256
BUCLO down LED suspended		p. 252
BUCLO giro LED suspended	new	p. 256
BUCLO hoop LED suspended	new	p. 256
BUCLO in LED suspended		p. 252
BUCLO ripples LED suspended	new	p. 256
BUCLO up LED suspended		p. 252

C

CONA E27 suspended		p. 262
CONA LED suspended		p. 262
CAST BALL LED surface	new	p. 176

D

DART LED exterior spot		p. 558
DART LED exterior upright		p. 558
DART LED exterior engine		p. 558
DART LED 24V exterior upright	new	p. 556
DART LED 24V exterior engine	new	p. 556

E

EMOT round LED wall		p. 460
EMOT squares LED wall		p. 460
EMOT round sensor LED wall	new	p. 460
EMOT squares sensor LED wall	new	p. 460

F

FLARED cast G E27 suspended		p. 270
FLARED cast G LED suspended		p. 270
FLYING BALL arc WP x3 LED suspended		p. 294

H

HOLLOW GU10 recessed		p. 086
HOLLOW micro LED recessed		p. 080
HOLLOW micro LED hermetic recessed		p. 084
HOLLOW move LED recessed		p. 086
HOLLOW LED recessed		p. 080
HOLLOW LED hermetic recessed		p. 084
HYPHER zoom LED high multitrack		p. 426
HYPHER zoom LED spot		p. 168
HYPHER zoom LED SR spot		p. 094
HYPHER zoom LED multitrack		p. 426
HYPHER zoom LED track		p. 426

I

IKI E27 suspended		p. 272
IKI round E27 wall		p. 482
IKI round LED wall		p. 482

K

KLIVA E27 suspended		p. 280
KLIVA E27 surface		p. 144
KLIVA LED suspended		p. 280
KLIVA LED surface		p. 144
KYO LED 24V exterior upright	new	p. 532

L

LEDPOINT round exterior wall		p. 540
LEDPOINT round up&down exterior wall		p. 540
LEDPOINT square exterior wall		p. 540

LEDPOINT square up&down exterior wall	p. 540
LENS LINE 180x89 LC LED recessed	p. 118
LENS LINE 180x89 LC LED surface	p. 220
LENS LINE 180x89 RC LED recessed	p. 118
LENS LINE 180x89 RC LED surface	p. 220
LENS LINE LED recessed	p. 118
LENS LINE LED section recessed	p. 118
LENS LINE LED section suspended	p. 322
LENS LINE LED section surface	p. 220
LENS LINE LED surface	p. 220

M

MAXI POINT LED exterior upright	p. 548
MAXI POINT round LED exterior wall	p. 548
MAXI POINT round LED wall	p. 484
MAXI POINT round LED SR wall	p. 484
MAXI RING dot LED suspended	p. 310
MAXI RING dot LED surface	p. 186
MIDI RING dot LED suspended	p. 310
MIDI RING dot LED surface	p. 186
MIDI RING rim LED surface	p. 192
MIDI RING rim LED recessed	p. 098
MINI RING rim LED surface	p. 192
MINI RING rim LED recessed	p. 098
MIXLINE INV LED suspended	p. 324
MIXLINE INV LED surface	p. 214
MIXLINE INV LED recessed	p. 116
MIXLINE LED suspended	p. 324
MIXLINE LED surface	p. 214
MIXLINE LED recessed	p. 116
MODERN BALL asymmetry x4 LED suspended	p. 296
MODERN BALL LED surface	p. 182
MODERN BALL x2 LED surface	p. 182
MODERN BALL x3 LED surface	p. 182
MODERN BALL x3 LED suspended	p. 296
MODERN BALL LED table	p. 514
MODERN BALL simple maxi PW LED hermetic surface	p. 178
MODERN BALL simple maxi PW LED suspended	p. 298
MODERN BALL simple maxi PW LED SR suspended	p. 298
MODERN BALL simple midi PW LED hermetic surface	p. 178
MODERN BALL simple midi PW LED hermetic SR surface	p. 178
MODERN BALL simple midi PW LED high multitrack	p. 448
MODERN BALL simple midi PW LED multitrack	p. 448
MODERN BALL simple midi PW LED suspended multitrack	p. 448
MODERN BALL simple midi PW LED suspended	p. 298
MODERN BALL simple midi PW LED SR suspended	p. 298
MODERN BALL simple midi PW LED suspended track	p. 448
MODERN BALL simple midi PW LED track	p. 448
MODERN BALL simple mini PW LED hermetic surface	p. 178
MODERN BALL simple mini PW LED hermetic SR surface	p. 178
MODERN BALL simple mini PW LED microtrack	p. 448
MODERN BALL simple mini PW LED suspended microtrack	p. 448
MODERN BALL simple mini PW LED suspended	p. 298
MODERN BALL simple mini PW LED SR suspended	p. 298
MODERN GLASS Barrel E27 suspended	p. 290

MODERN GLASS Barrel GU10 suspended	p. 290
MODERN GLASS Barrel LED suspended	p. 290
MODERN GLASS Flared E27 suspended	p. 290
MODERN GLASS Flared GU10 suspended	p. 290
MODERN GLASS Flared LED suspended	p. 290
MODERN GLASS mini LED SR suspended	p. 286
MODERN GLASS mini LED suspended	p. 286
MODERN GLASS Tube E27 suspended	p. 290
MODERN GLASS Tube GU10 suspended	p. 290
MODERN GLASS Tube LED suspended	p. 290
MODERN GLASS Tube LED SR suspended	p. 290
MODERN GLASS Tube LED wall	p. 480
MODERN GLASS Tube LED hermetic wall	p. 480
MROOM LED exterior table	p. 510
MROOM LED upright	p. 510

O

ONLY round mini LED 230V exterior recessed	p. 536
ONLY round mini LED 230V exterior surface	p. 536
OPTIMA up&down LED suspended	p. 332

P

PET GU10 spot	p. 162
PET GU10 track	p. 420
PET GU10 surface	p. 154
PET maxi LED spot	p. 162
PET maxi LED SR spot	p. 092
PET maxi LED suspended	p. 306
PET maxi LED surface	p. 154
PET maxi LED track	p. 420
PET micro LED upright	p. 516
PET micro O LED wall	p. 472
PET micro O switch LED wall	p. 472
PET micro R LED wall	p. 472
PET micro R USB LED wall	p. 472
PET micro R switch LED wall	p. 472
PET micro R switch USB LED wall	p. 472
PET midi asymmetry LED spot	new p. 164
PET midi E LED spot	p. 164
PET midi LED hermetic surface	new p. 154
PET midi LED high multitrack	p. 420
PET midi LED microtrack	new p. 420
PET midi LED multitrack	p. 420
PET midi LED spot	p. 162
PET midi LED SR spot	p. 092
PET midi LED surface	p. 154
PET midi LED suspended	p. 306
PET midi LED SR suspended	p. 306
PET midi LED track	p. 420
PET midi LED wall	p. 470
PET mini asymmetry LED spot	new p. 164
PET mini E LED spot	p. 164
PET mini horiz LED suspended	p. 304
PET mini LED hermetic surface	new p. 154

PET mini LED high multitrack	p. 416
PET mini LED microtrack	p. 416
PET mini LED multitrack	p. 416
PET mini LED spot	p. 162
PET mini LED SR spot.....	p. 092
PET mini LED surface.....	p. 154
PET mini LED suspended.....	p. 306
PET mini LED SR suspended	p. 306
PET mini LED suspended microtrack	p. 416
PET mini LED suspended multitrack	p. 416
PET mini LED track	p. 416
PET mini LED wall.....	p. 472
PET LED 230V exterior surface.....	p. 538
PIPER move LED 230V wall	p. 486
PIPER LED 230V suspended	p. 274
PIPER LED 230V wall	p. 486
PIPER vert LED 230V suspended	p. 274
PUTT maxi LED recessed	p. 068
PUTT maxi move LED recessed	p. 074
PUTT maxi LED trimless recessed.....	p. 072
PUTT midi LED hermetic recessed	p. 076
PUTT midi LED recessed	p. 068
PUTT midi LED trimless recessed.....	p. 072
PUTT midi move LED hermetic recessed	p. 076
PUTT midi move LED recessed.....	p. 074
PUTT midi move LED trimless recessed.....	p. 074
PUTT mini LED hermetic recessed	p. 076
PUTT mini LED recessed.....	p. 068
PUTT mini LED trimless recessed.....	p. 072

Q

QRLED next hermetic surface	p. 136
QRLED next high multitrack	p. 408
QRLED next E spot.....	new p. 132
QRLED next microtrack.....	new p. 408
QRLED next move trim recessed.....	p. 062
QRLED next move trimless recessed	p. 062
QRLED next multitrack	p. 408
QRLED next spot.....	p. 136
QRLED next SR spot.....	p. 066
QRLED next suspended	p. 278
QRLED next suspended microtrack	new p. 408
QRLED next suspended multitrack	p. 408
QRLED next track	p. 408
QRLED next trim recessed.....	p. 062
QRLED next trimless recessed	p. 062

R

RAFTER mini LED multitrack	p. 430
RAFTER mini move LED high multitrack.....	p. 430
RAFTER mini move LED microtrack	new p. 430
RAFTER mini move LED multitrack	p. 430
RAFTER mini points LED microtrack	p. 432
RAFTER mini points LED multitrack	p. 432

RAFTER mini points move LED high multitrack	p. 432
RAFTER mini points move LED microtrack	p. 432
RAFTER mini points move LED multitrack	p. 432
RAFTER mini points move LED recessed	p. 110
RAFTER mix LED surface.....	p. 212
RAFTER mix LED recessed	p. 114
RAFTER LED high multitrack	p. 436
RAFTER LED multitrack	p. 436
RAFTER LED recessed	p. 112
RAFTER LED surface	p. 210
RAFTER LED suspended.....	p. 330
RAFTER LED track.....	p. 436
RAFTER LED wall.....	p. 494
RAFTER points LED high multitrack	p. 438
RAFTER points LED microtrack	p. 438
RAFTER points LED multitrack	p. 438
RAFTER points LED recessed.....	p. 106
RAFTER points LED section recessed	p. 106
RAFTER points LED section surface.....	p. 206
RAFTER points LED section suspended.....	p. 328
RAFTER points LED spot.....	p. 206
RAFTER points LED SR spot.....	p. 106
RAFTER points LED surface.....	p. 206
RAFTER points LED track	p. 438
RAFTER points LED trim recessed.....	p. 104
RAFTER points SQ LED trim recessed	p. 104
RAFTER wall washer LED trim recessed.....	p. 110
RIBBY circle up&down LED suspended	p. 244
RIBBY line points up&down LED suspended	new p. 248
RIBBY line up&down LED suspended	p. 248
RIBBY round up&down LED suspended	new p. 244
RIBBY up LED wall.....	new p. 466
RIBBY up&down LED wall.....	p. 466
RIBBY up&task LED wall	new p. 466

S

SENSO LED exterior wall	new p. 534
SET RAW mini move LED wall	p. 490
SET RAW mini LED hermetic wall.....	p. 490
SET RAW mini LED recessed.....	p. 120
SET RAW mini LED suspended	p. 320
SET TRU mini LED multitrack.....	p. 442
SET TRU mini points LED multitrack	p. 442
SET TRU LED hermetic surface.....	p. 224
SET TRU LED hermetic wall.....	p. 496
SET TRU LED recessed.....	p. 122
SET TRU LED suspended	p. 338
SET TRU LED surface.....	p. 224
SET TRU LED trim recessed.....	p. 122
SET TRU LED wall.....	p. 496
SET TRU PRO LED recessed	p. 122
SET TRU PRO LED trim recessed	p. 122
SIRCA LED recessed	p. 096
SLUP LED exterior upright.....	p. 550
SNOP E27 surface.....	p. 140

SNOP E27 suspended	p. 266
SNOP QRLED surface	p. 140
SNOP QRLED suspended.....	p. 266
SWING next GU10 recessed.....	p. 088
SWING next GU10 trimless recessed.....	p. 088
SWING next LED recessed	p. 088
SWING next LED trimless recessed.....	p. 088

Systems

system ALULINE midi LED surface.....	p. 600
system ALULINE mini LED recessed	p. 600
system ALULINE mini LED surface.....	p. 600
system ALULINE mini LED trimless recessed.....	p. 600
system BEADS ball LED microtrack.....	new p. 572
system BEADS cone LED microtrack	new p. 572
system BEADS disc LED microtrack	new p. 572
system IKI round E27 spider suspended.....	p. 584
system IKI round LED spider suspended.....	p. 584
system LEDLINE soft recessed	p. 602
system MAXI POINT round LED spider wall	p. 584
system MAXI POINT square LED spider wall	p. 584
system MIXLINE LED recessed.....	p. 606
system MIXLINE LED surface.....	p. 606
system MIXLINE LED suspended	p. 606
system MODERN BALL simple maxi LED spider suspended	p. 584
system MODERN BALL simple midi LED spider suspended.....	p. 584
system MODERN BALL simple mini LED spider suspended.....	p. 584
system MODERN GLASS E27 spider suspended	p. 584
system MODERN GLASS GU10 spider suspended	p. 584
system MODERN GLASS mini LED spider suspended.....	p. 584
system MODERN GLASS LED spider suspended	p. 584
system OPTIMA LED suspended.....	new p. 578
system PET midi LED spider suspended.....	p. 584
system PET midi rift LED surface	p. 596
system PET midi rift LED suspended	p. 596
system PET mini LED spider suspended.....	p. 584
system PET mini rift LED suspended.....	p. 596
system PET mini rift LED wall	p. 596
system PIPER LED 230V suspended.....	p. 590
system QRLED next spider suspended	p. 584
system RAFTER mix LED recessed	p. 618
system RAFTER mix LED suspended.....	p. 618
system RAFTER mix LED surface	p. 618
system SET RAW mini LED recessed	p. 610
system TRIBA midi E27 spider suspended.....	p. 584
system TRIBA midi GU10 spider suspended	new p. 584
system TRIBA midi LED spider suspended.....	p. 584
system TRIBA mini LED spider suspended	p. 584
system TRU LED recessed.....	p. 614
system TRU LED surface.....	p. 614
system TRU LED suspended	p. 614
system TRU LED trim suspended.....	p. 614
system TRU up&down LED suspended.....	p. 614

T

THIN TUBE asymmetry LED suspended	p. 316
THIN TUBE central LED suspended	p. 316
THIN TUBE LED hermetic wall	p. 492
THIN TUBE LED upright.....	p. 520
THIN TUBE twist LED hermetic wall.....	p. 492
TRIBA midi GU10 spot	new p. 152
TRIBA midi GU10 surface.....	new p. 152
TRIBA midi GU10 suspended.....	new p. 282
TRIBA midi GU10 suspended track	new p. 412
TRIBA midi GU10 track.....	new p. 412
TRIBA midi E27 surface.....	p. 152
TRIBA midi E27 suspended	p. 282
TRIBA midi E27 suspended track.....	p. 412
TRIBA midi LED spot.....	p. 148
TRIBA midi LED SR spot	p. 090
TRIBA midi LED surface	p. 148
TRIBA midi LED suspended.....	p. 282
TRIBA midi LED track	p. 412
TRIBA mini LED high multitrack.....	p. 414
TRIBA mini LED microtrack	p. 414
TRIBA mini LED multitrack	p. 414
TRIBA mini LED SR spot	p. 090
TRIBA mini LED suspended	p. 282
TRIBA mini LED suspended microtrack.....	new p. 414
TRIBA mini LED suspended multitrack.....	p. 414
TRIBA mini LED up&down wall.....	p. 470
TRIBA mini LED wall	p. 470
TUBE flex LED high multitrack.....	p. 444
TUBE flex LED multitrack	p. 444
TUBE stiff LED multitrack.....	p. 444

V

VIP round LED 230V exterior wall	p. 544
VIP round up&down LED 230V exterior wall.....	p. 544
VIP square LED 230V exterior wall	p. 544
VIP square up&down LED 230V exterior wall.....	p. 544
VYRO x1 round move LED surface.....	p. 172
VYRO x1 round LED 230V surface.....	p. 172
VYRO x1 square LED 230V surface.....	p. 172
VYRO x2 round move LED surface.....	p. 172
VYRO x2 round LED 230V surface.....	p. 172
VYRO x2 square LED 230V surface.....	p. 172

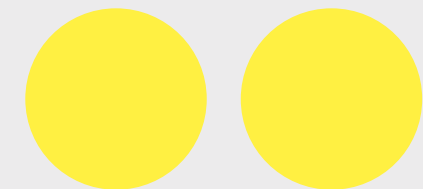

QS INDEX

by name



B

BLOS round distance LED hermetic M930 surface white..... 47019-M930-D9-00-13 [p. 198](#)

D

DART 38 LED 24V exterior M927 33° CV upright black..... 26594-M927-F1-CV-12 [p. 556](#)
 DART 38 LED exterior M930 33° upright black..... 26539-M930-F1-00-12 [p. 558](#)

E

EMOT round LED M930 wall white 26589-M930-DW-00-13 [p. 460](#)
 EMOT round LED M930 wall black 26589-M930-DB-00-12 [p. 460](#)
 EMOT round LED M930 wall taupe..... 26589-M930-DT-00-82 [p. 460](#)
 EMOT square LED M930 wall white 26590-M930-DW-00-13 [p. 460](#)

H

HOLLOW 6 LED hermetic M930 49° recessed white 38059-M930-WW-00-13 [p. 080](#)
 HOLLOW 6 LED M930 49° recessed white..... 38058-M930-WW-00-13 [p. 080](#)
 HOLLOW 6 LED M930 49° recessed black 38058-M930-WB-00-12 [p. 086](#)
 HOLLOW 8 GU10 Phase-Control recessed white..... 38054-G000-00-PH-13 [p. 086](#)
 HOLLOW 8 GU10 Phase-Control recessed black..... 38054-G000-00-PH-12 [p. 086](#)
 HOLLOW 8 LED M930 41° recessed white..... 38051-M930-WW-00-13 [p. 086](#)
 HOLLOW 8 lens LED M930 34° recessed white 38055-M930-FW-00-13 [p. 086](#)
 HOLLOW 8 lens move LED M930 34° recessed white 38057-M930-FW-00-13 [p. 084](#)
 HOLLOW 8 move LED M930 41° recessed white 38053-M930-WW-00-13 [p. 084](#)
 HOLLOW micro LED hermetic M930 30° recessed white..... 38011-M930-FW-00-13 [p. 084](#)
 HOLLOW micro LED M930 30° recessed white 37986-M930-FW-00-13 [p. 084](#)
 HOLLOW micro LED M930 30° recessed black 37986-M930-FB-00-12 [p. 080](#)

K

KLIVA E27 Phase-Control surface terracotta 47042-E000-00-PH-83 [p. 144](#)
 KYO 60 LED 24V exterior M927 CV upright black 26604-M927-D9-CV-12 [p. 532](#)

L

LEDPOINT square exterior M927 68° wall black 26546-M927-WB-00-12 [p. 540](#)
 LEDPOINT square exterior M930 68° wall black 26546-M930-WB-00-12 [p. 540](#)
 LEDPOINT square up&down exterior M927 68° wall black..... 26547-M927-WB-00-12 [p. 540](#)
 LENS LINE 149 LED section M930 54° surface white 40262-M930-W3-00-13 [p. 540](#)

M

MAXI RING dot LED M930 Phase-Control surface black + white..... 47027-M930-DW-PH-12 [p. 186](#)
 MIDI RING rim LED M930 surface white..... 47020-M930-D9-00-13 [p. 192](#)
 MIDI RING rim LED M930 recessed white..... 38030-M930-D9-00-13 [p. 098](#)
 MINI RING rim LED M930 surface white..... 47026-M930-D9-00-13 [p. 192](#)
 MINI RING rim LED M930 surface black 47026-M930-D9-00-12 [p. 192](#)
 MINI RING rim LED M930 recessed white..... 38031-M930-D9-00-13 [p. 098](#)
 MIXLINE 160 LED M930 54° surface white..... 40286-M930-W3-00-13 [p. 214](#)
 MIXLINE 160 LED M930 54° surface black..... 40286-M930-W3-00-12 [p. 214](#)
 MIXLINE 160 LED M930 54° recessed black..... 30225-M930-W3-00-12 [p. 116](#)
 MIXLINE 160 LED M940 54° surface black..... 40286-M940-W3-00-12 [p. 214](#)
 MIXLINE 167 INV LED M930 54° surface white..... 40289-M930-W3-00-13 [p. 214](#)
 MIXLINE 188 LED M930 54° surface black..... 40287-M930-W3-00-12 [p. 214](#)
 MIXLINE 192 INV LED M930 54° surface white 40290-M930-W3-00-13 [p. 214](#)
 MIXLINE 192 INV LED M930 54° recessed black..... 30229-M930-W3-00-12 [p. 116](#)
 MIXLINE 216 LED M930 54° surface white 40288-M930-W3-00-13 [p. 214](#)
 MIXLINE 216 LED M930 54° surface black 40288-M930-W3-00-12 [p. 214](#)
 MIXLINE 216 LED M930 54° recessed black..... 30227-M930-W3-00-12 [p. 116](#)
 MIXLINE 216 LED M940 54° surface black..... 40288-M940-W3-00-12 [p. 214](#)
 MODERN BALL simple midi PW LED hermetic M930 surface white..... 47000-M930-PW-00-13 [p. 178](#)
 MODERN BALL simple midi PW LED hermetic M930 surface black..... 47000-M930-PW-00-12 [p. 178](#)
 MROOM LED exterior M927 Touch Dim table taupe 26576-M927-D9-TD-82 [p. 514](#)
 MROOM LED exterior M930 Touch Dim table black..... 26576-M930-D9-TD-12 [p. 514](#)
 MROOM LED exterior M930 Touch Dim table terracotte 26576-M930-D9-TD-83 [p. 514](#)

O

ONLY round mini 7 LED 230V exterior M927 40° Phase-Control surface black..... 47018-M927-W3-PH-12 [p. 536](#)
 ONLY round mini 7 LED 230V exterior M930 40° Phase-Control surface white..... 47018-M930-W3-PH-13 [p. 536](#)
 ONLY round mini 7 LED 230V exterior M930 40° Phase-Control surface black..... 47018-M930-W3-PH-12 [p. 536](#)
 ONLY round mini 7 LED 230V exterior M930 Phase-Control surface white..... 47018-M930-D9-PH-13 [p. 536](#)

P

PET 9 GU10 Phase-Control surface white..... 42311-G000-00-PH-13 [p. 154](#)
 PET 9 GU10 Phase-Control surface black 42311-G000-00-PH-12 [p. 154](#)
 PET GU10 Phase-Control spot white 10045-G000-00-PH-13 [p. 162](#)
 PET GU10 Phase-Control spot black 10045-G000-00-PH-12 [p. 162](#)
 PET GU10 Phase-Control track white..... 12548-G000-00-PH-13 [p. 420](#)
 PET GU10 Phase-Control track black..... 12548-G000-00-PH-12 [p. 420](#)
 PET LED 230V exterior M930 27° Phase-Control surface white..... 47029-M930-F3-PH-13 [p. 538](#)
 PET LED 230V exterior M930 27° Phase-Control surface black..... 47029-M930-F3-PH-12 [p. 538](#)
 PET micro R LED M927 32° wall black 26504-M927-F3-00-12 [p. 474](#)
 PET micro R LED M930 32° wall white 26504-M930-F3-00-13 [p. 474](#)
 PET micro R LED M930 32° wall black 26504-M930-F3-00-12 [p. 474](#)
 PET micro R switch LED M927 32° wall black..... 26508-M927-F3-00-12 [p. 474](#)
 PET micro R switch LED M930 32° wall white..... 26508-M930-F3-00-13 [p. 474](#)
 PET micro R switch LED M930 32° wall black..... 26508-M930-F3-00-12 [p. 474](#)
 PET midi 12 LED M930 35° surface white..... 46962-M930-FW-00-13 [p. 154](#)
 PET midi 12 LED M930 50° surface white..... 46962-M930-WW-00-13 [p. 154](#)
 PET midi 12 LED M930 50° surface black..... 46962-M930-WB-00-12 [p. 154](#)
 PET midi LED high M930 35° DALI multitrack black 16433-M930-FB-DA-12 [p. 420](#)
 PET midi LED high M930 35° multitrack black 16433-M930-FB-00-12 [p. 420](#)
 PET midi LED high M930 50° multitrack white 16433-M930-WW-00-13 [p. 420](#)
 PET midi LED high M930 50° multitrack black 16433-M930-WB-00-12 [p. 420](#)

PET midi LED M930 35° spot white	16363-M930-FW-00-13	p. 154
PET midi LED M930 50° spot white	16363-M930-WW-00-13	p. 154
PET midi LED M930 35° track black.....	16362-M930-FB-00-12	p. 420
PET midi LED M930 50° DALI multitrack black.....	16366-M930-WB-DA-12	p. 420
PET midi LED M930 50° multitrack white	16366-M930-WW-00-13	p. 420
PET midi LED M930 50° multitrack black	16366-M930-WB-00-12	p. 420
PET midi LED M930 50° track white.....	16362-M930-WW-00-13	p. 420
PET midi LED M930 50° track black.....	16362-M930-WB-00-12	p. 420
PET mini 12 LED M930 41° surface white.....	46959-M930-WW-00-13	p. 154
PET mini LED high M930 41° DALI multitrack black.....	16435-M930-WB-DA-12	p. 416
PET mini LED high M930 41° multitrack white	16435-M930-WW-00-13	p. 416
PET mini LED high M930 41° multitrack black	16435-M930-WB-00-12	p. 416
PET mini LED M930 41° DALI multitrack black.....	16367-M930-WB-DA-12	p. 416
PET mini LED M930 41° multitrack white	16367-M930-WW-00-13	p. 416
PET mini LED M930 41° multitrack black	16367-M930-WB-00-12	p. 416
PET mini LED M930 41° spot white	16359-M930-WW-00-13	p. 162
PET mini LED M930 41° spot black	16359-M930-WB-00-12	p. 162
PET mini LED M930 41° track white.....	16358-M930-WW-00-13	p. 416
PET mini LED M930 41° track black.....	16358-M930-WB-00-12	p. 416
PIPER 150 LED 230V M942 Phase-Control suspended black.....	59937-M942-D9-PH-12	p. 274
PIPER system 130 LED 230V M942 Phase-Control suspended black.....	71264-M942-D9-PH-12	p. 590
PIPER system 150 LED 230V M942 Phase-Control suspended black.....	71265-M942-D9-PH-12	p. 590
PUTT midi GU10 Phase-Control recessed white	38048-G000-00-PH-13	aqform.com/PT2033
PUTT midi LED M930 50° recessed white.....	38015-M930-WW-00-13	p. 068
PUTT midi LED trimless M930 35° recessed white	38016-M930-FW-00-13	p. 072
PUTT midi LED trimless M930 50° recessed white	38016-M930-WW-00-13	p. 072
PUTT midi LED trimless M930 50° recessed black	38016-M930-WB-00-12	p. 072
PUTT midi move LED hermetic M930 35° recessed white.....	38047-M930-FW-00-13	p. 076
PUTT midi move LED hermetic M930 50° recessed white.....	38047-M930-WW-00-13	p. 076
PUTT midi move LED M930 50° recessed white	38042-M930-WW-00-13	p. 074
PUTT mini LED hermetic M930 41° recessed white.....	38046-M930-WW-00-13	p. 076
PUTT mini LED M930 41° recessed white.....	38013-M930-WW-00-13	p. 068
PUTT mini LED trimless M930 41° recessed white	38014-M930-WW-00-13	p. 072
PUTT mini LED trimless M930 41° recessed black	38014-M930-WB-00-12	p. 072

Q

QRLED next hermetic L930 52° surface white	47063-L930-W3-00-13	p. 136
QRLED next hermetic L930 52° surface black	47063-L930-W3-00-12	p. 136
QRLED next hermetic M930 52° surface white.....	47063-M930-W3-00-13	p. 136
QRLED next hermetic M930 52° surface black.....	47063-M930-W3-00-12	p. 136
QRLED next L930 52° spot white	16487-L930-W3-00-13	p. 136
QRLED next M930 52° spot white.....	16487-M930-W3-00-13	p. 136
QRLED next E x1 L930 52° spot white.....	16525-L930-W3-00-13	p. 132
QRLED next E x1 L930 52° spot black.....	16525-L930-W3-00-12	p. 132
QRLED next E x2 L930 52° spot white.....	16526-L930-W3-00-13	p. 132
QRLED next E x2 L930 52° spot black.....	16526-L930-W3-00-12	p. 132

R

RAFTER mini 20 LED M930 multitrack white	16461-M930-D9-00-13	p. 430
RAFTER mini 20 LED M930 multitrack black	16461-M930-D9-00-12	p. 430
RAFTER mini points 10 LED M930 45° DALI multitrack black + black optic.....	16457-M930-WB-DA-12	p. 432
RAFTER mini points 10 LED M930 45° multitrack black	16457-M930-WB-00-12	p. 432
RAFTER mini points 20 LED M930 45° DALI multitrack black.....	16458-M930-WB-DA-12	p. 432
RAFTER mini points 20 LED M930 45° multitrack white + white optic	16458-M930-WW-00-13	p. 432

RAFTER mini points 20 LED M930 45° multitrack black.....	16458-M930-WB-00-12	p. 432
RAFTER mini points 20 LED M930 45° multitrack black + black optic.....	16458-M930-WB-01-12	p. 432
RAFTER points 27 LED L930 50° recessed black + black optic.....	30270-L930-WB-00-12	p. 106
RIBBY up&task 19 LED M930 wall black.....	26599-M930-Y6-00-12	p. 466

S

SET RAW mini 58 LED L930 hermetic wall white.....	26346-L930-D9-00-13	p. 490
SET TRU mini 114 LED M930 DALI multitrack black.....	16375-M930-D9-DA-12	p. 442
SET TRU mini 57 LED M930 DALI multitrack black.....	16374-M930-D9-DA-12	p. 442
SET TRU mini 57 LED M930 multitrack white.....	16374-M930-D9-00-13	p. 442
SET TRU mini 57 LED M930 multitrack black.....	16374-M930-D9-00-12	p. 442
SET TRU mini 57 LED M940 multitrack black.....	16374-M940-D9-00-12	p. 442
SET TRU mini points 28 LED M930 59° DALI multitrack black	16379-M930-WB-DA-12	p. 442
SET TRU mini points 28 LED M930 59° multitrack black.....	16379-M930-WB-00-12	p. 442
SET TRU mini points 56 LED M930 59° DALI multitrack black	16380-M930-WB-DA-12	p. 442
SET TRU mini points 56 LED M930 59° multitrack black.....	16380-M930-WB-00-12	p. 442
SIRCA 10 LED M930 59° recessed white.....	37988-M930-WW-00-13	p. 096

V

VYRO x1 round move LED M930 59° Phase-Control surface white.....	47037-M930-WW-PH-13	p. 172
--	---------------------------	------------------------

accessory

BLOS round PRO diffuser set white	81300-13	For trimless luminaires, it is possible to
MOUNTING FRAME FOR PUTT maxi trimless natural aluminium.....	81249-11	order the mounting frame and the luminaire
MOUNTING FRAME FOR PUTT midi move trimless natural aluminium.....	81250-11	insert separately. More information can be
MOUNTING FRAME FOR PUTT midi trimless natural aluminium.....	81248-11	found in the technical brochure.
MOUNTING FRAME FOR PUTT mini trimless natural aluminium.....	81247-11	
MOUNTING FRAME FOR QRLED next move trimless natural aluminium.....	81261-11	
MOUNTING FRAME FOR QRLED next trimless natural aluminium.....	81256-11	

MODERN BALL simple midi LED hermetic surface



LED SPEC

LED lifetime

LED LIFETIME is the declared period of time for which a LED light source maintains its high quality and efficiency. Unlike traditional light sources, LEDs do not burn out suddenly - their luminous flux gradually decreases over time. LED lifespan is most often defined as the number of operating hours after which the luminous flux drops to a specific level, such as L70 - meaning the fixture still emits at least 70% of its initial light output. In practice, L80 standard is applied the most often.

LxxByy - What does it mean?

Lxx - Luminous Flux Maintenance

xx indicates the percentage of the initial luminous flux that remains after a specified operating time.

Example:

- L70 → the diode emits at least 70% of the initial luminous flux
- L80 → the diode emits at least 80% of the initial luminous flux

Byy - Parameter Spread (Non-Uniformity)

yy indicates the maximum percentage of diodes that may not meet the Lxx criterion. Example:

- B10 → a maximum of 10% of the LEDs may have a flux lower than the specified level (e.g., L70)
- B50 → up to 50% of the LEDs may fall below this value

Examples in practice

L70B10 60,000 hours

After 60,000 hours:

At least 90% of the LEDs operate at a brightness ≥ 70% of their initial value

L80B50 50,000 hours

After 50,000 hours:

Half of the LEDs retain at least 80% of their initial flux

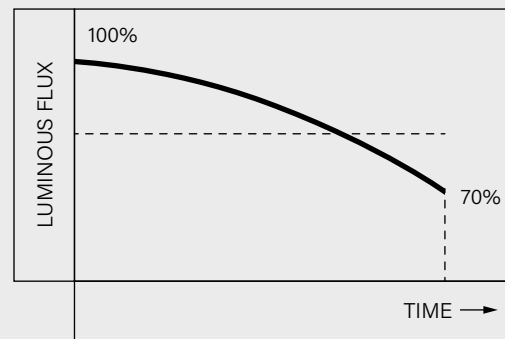

L70B10

At least 90% of the LEDs maintain 70% of the initial luminous flux

Draw L70B10: after the specified operating time, 90% of LED diodes emit at least 70% of the initial luminous flux.

Why is LxxByy important?

- It precisely describes what manufacturer had in mind exactly when indicating the product lifetime,
- enables objective comparisons of LED luminaires,
- provides real information about the durability and stability of the installation,
- is a standard used in the LM-80 / TM-21 standards.

detailed table

LED Model *	LED Power [W]	Luminous flux at Tc=75°C			Typical values		Approximate lifetime		SDCM Value
		2700K	3000K	4000K	Forward current [mA]	Forward voltage [V]	LxxByy	Hours	
A	2,0	213	223	236	700	2,88	L90B50	60000	3
B	4,3	519	543	574	500	8,6	L90B50	56000	3
C	8,8	982	1027	1086	250	35,2	L90B50	56000	3
D	5,8	759	794	840	350	16,7	L90B50	56000	3
E	8,6	1050	1097	1161	500	17,2	L90B50	56000	3
F	12,0	2100	2194	2322	350	34,4	L90B50	56000	3
G	8,8	1085	1134	1200	350	25,1	L90B50	56000	3
H	8,6	1099	1149	1216	250	34,2	L90B50	56000	3
I	12,4	1845	1533	1643	350	35,3	L90B50	56000	3
J	18,5	2028	2120	2243	500	36,9	L90B50	56000	3
K	11,5	1547	1617	1711	350	32,8	L90B50	56000	3
L	16,8	2163	2261	2392	500	33,6	L90B50	56000	3
M	12,5	N/A	1384	1477	350	35,6	L90B50	50000	3
N	17,3	N/A	2203	2354	500	34,5	L90B50	50000	3
O	2,0	220	218	240	700	2,88	L90B50	60000	3
P	2,8	325	315	358	500	5,64	L90B50	60000	3
Q	2,9	357	336	393	350	8,31	L90B50	60000	3
R	1,0	119	113	131	350	2,77	L90B50	60000	3
S	7,0	783	837	829	500	14	L90B50	60000	3
T	14,0	1566	1674	1658	500	28	L90B50	60000	3
U	21,0	2349	2511	2487	500	42	L90B50	60000	3
V	4,9	547	602	665	350	14	L90B50	60000	3
W	4,9	486	505	571	350	14	L90B50	60000	3
X	9,8	972	1010	1142	350	28	L90B50	60000	3
Y	14,7	1458	1515	1713	350	42	L90B50	60000	3
Z	5,8	636	691	673	500	11,5	L90B10	72000	3
AA	12,6	1388	1523	1477	500	25,2	L90B10	72000	3
AB	8,6	711	817	954	500	17,2	L90B50	50000	3
AC	17,2	1422	1634	1908	500	34,4	L90B50	50000	3

* LED model refers to a specific LED module that is used in the drivers CC table and assigned to specific luminaires in the catalogue.

IP RATED

In zone 1 and 2, all electrical appliances exposed to direct water jets require a minimum IPX4.

Based on PN-HD 60364-7-701:2025-02

Interiors containing a bathtub or a shower require certain ingress protection in luminaires, which depends on the localisation in all appliances.

Ingress Protection Rating (IP) usually contains two digits. The first one tells you how well a luminaire is protected against solids ingress. The second one is most important in the case of bathrooms and tells how waterproof a luminaire is.

Please note that normative references describe minimum requirements. Thus, it is crucial to take into account both the purpose and maintenance of the room. It is also important to take aggressive conditions under consideration. It could be steam condensation, constant high humidity or even overly curious kids.

HD 60364-7-701 applies to bathtubs and showers, yet it is a good practice to apply splash-proof (IP44) luminaires in and immediate area of all water outlets

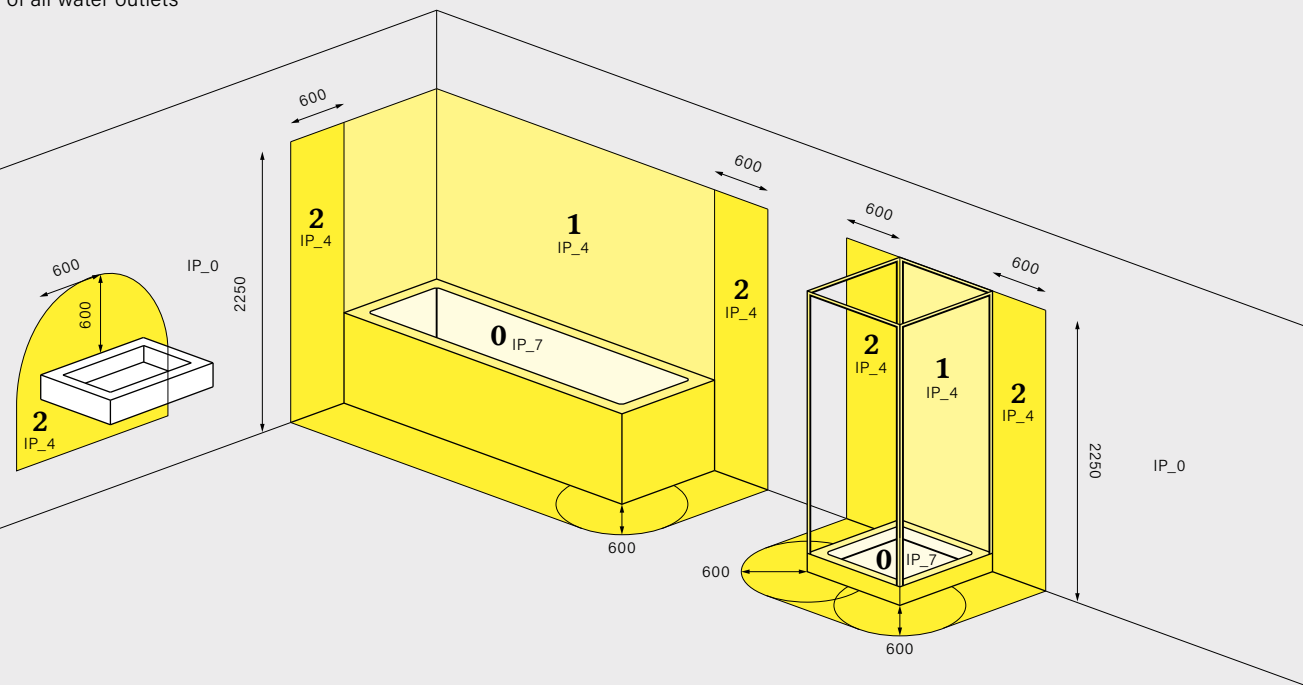

Please note there are national deviations.

Examples below:

- Spain, Czech Republic: zone 2 over zone 1 extended to 300cm
- Netherlands: 225cm dimension changes to 260cm
- Ireland: there is zone 3 240cm from zone 2 horizontally and 75cm above zones 1 and 2
- France: zone 2 IPX3, there is zone 3 that extends 240cm from zone 2 horizontally.

based on PN-HD 60364-7-701:2010

EXTERIOR 24V SYSTEM

The Low Voltage 24 V outdoor lighting system offers maximum design flexibility combined with a high level of safety. Users can freely configure the installation by selecting luminaires, cables, connectors and a power supply tailored precisely to the requirements of the space.

Thanks to its low-voltage technology, the 24 V system is suitable for both temporary installations and permanent outdoor applications, such as gardens, terraces and architectural lighting projects. The modular structure allows for easy expansion and adjustment of the system without interfering with the existing installation.

For reliable performance and long-term durability of the luminaires, the power supply manufacturer recommends maintaining at least a 20% power reserve relative to the total system load.

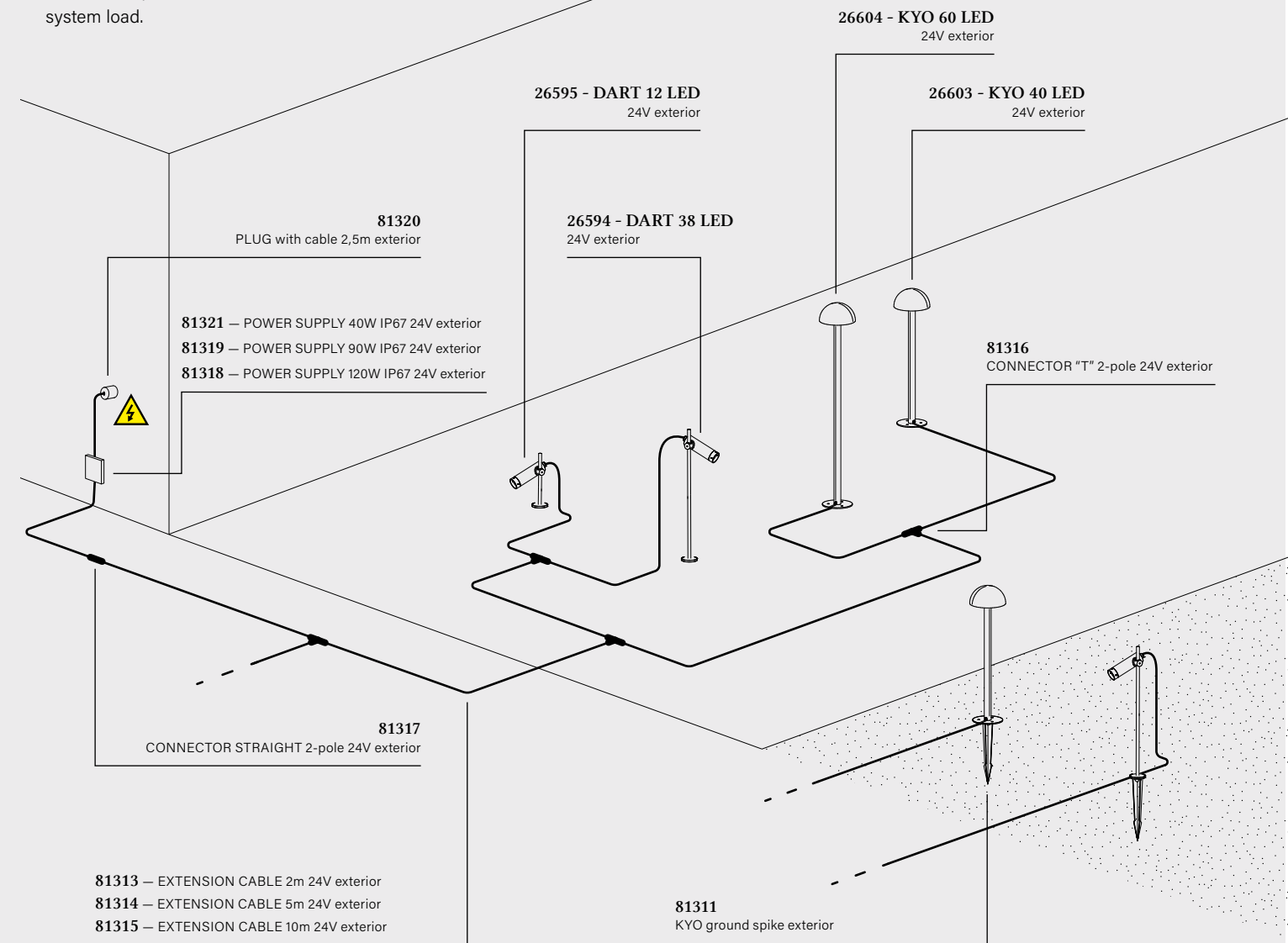

DIMENSIONS

of optics placement

MIXLINE

MIXLINE 160 LED recessed/surface/suspended

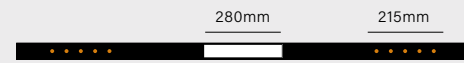

MIXLINE 188 LED recessed/surface/suspended

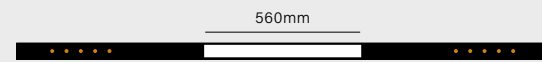

MIXLINE 216 LED recessed/surface/suspended

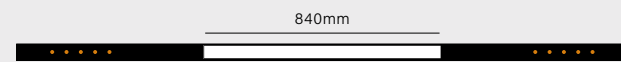

MIXLINE 167 INV LED recessed/surface/suspended



MIXLINE 192 INV LED recessed/surface/suspended



RAFTER

RAFTER points 54 LED section recessed/surface/suspended

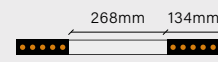

RAFTER points 94 LED section recessed/surface/suspended



RAFTER points 133 LED section recessed/surface/suspended

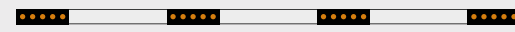

RAFTER points 173 LED section recessed/surface/suspended



RAFTER points 213 LED section recessed/surface/suspended



OPTIMA

OPTIMA 98 up&down LED suspended

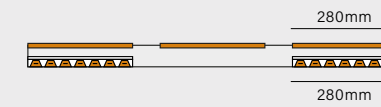

OPTIMA 138 up&down LED suspended

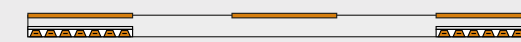

OPTIMA 168 up&down LED suspended

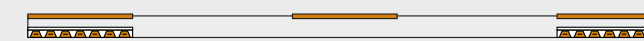

OPTIMA 98 LED suspended

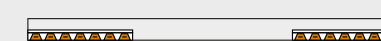

OPTIMA 138 LED suspended



OPTIMA 168 LED suspended

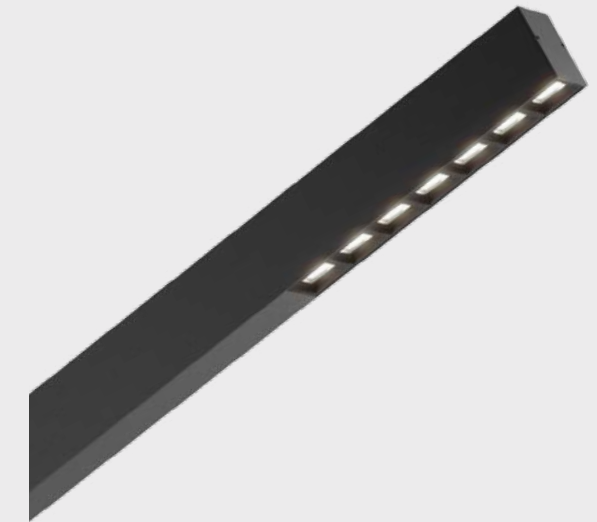
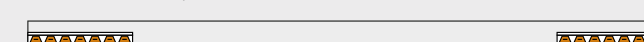

LENS LINE

LENS LINE 54 LED section surface



LENS LINE 96 LED section recessed/surface/suspended



LENS LINE 149 LED section recessed/surface/suspended



LENS LINE 202 LED section recessed/surface/suspended

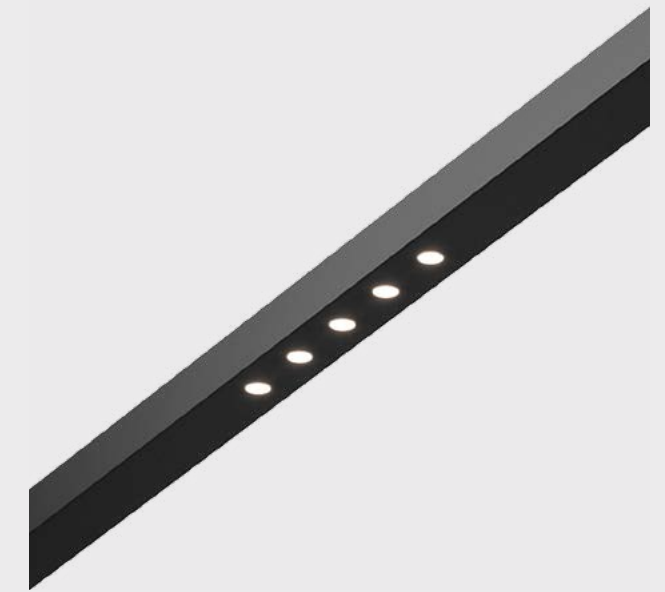

COLOUR BINNING / MACADAM STEPS

Every LED light source, even within the same colour temperature, exhibits natural, microscopic colour variations. Colour binning is a process of selecting LEDs that allows us to control these variations and maintain visual consistency in the finished luminaires.

the SDCM value, the higher the colour uniformity. In standard applications, this ensures visual comfort, while in demanding applications, it allows for the use of more precise selection for perfect colour perception.

With colour binning, all LED chips emit light of a similar hue, resulting in a harmonious interior appearance and a predictable design effect. Colour differences remain invisible in everyday use, even with multiple luminaires in a single space.

Colour binning is a key element of quality control, ensuring that the light doesn't attract attention with colour differences but consistently creates a pleasant interior atmosphere.

Colour consistency is described by the SDCM parameter, which determines the maximum colour deviation between lamps. The lower

Why it matters

Controlled colour binning ensures that light:

- appears uniform across a space
- remains visually consistent when multiple luminaires are used together
- delivers a predictable and professional lighting effect

Understanding SDCM

Colour consistency is defined by SDCM (Standard Deviation of Colour Matching), based on MacAdam ellipses, which represent colour differences perceptible to the human eye.

- SDCM 1 – special selection, near perfect colour uniformity
- SDCM 2 – very high colour consistency – difference undetectable by an eye
- SDCM 3 – standard catalogue consistency, visually uniform in most applications
 - only a trained observer capable of detecting inconsistency
- SDCM 4 – moderate colour tolerance, slight differences may be perceptible in sensitive environments
- SDCM 5 – extended colour tolerance, suitable for non-visually critical applications

---	Planckian Locus (BBL)
○	Target 3000K
■	1-step
■	2-step
■	3-step
■	5-step
■	7-step

Figure 1 Location of the 3000 K point on the Planckian Locus with MacAdam ellipses illustrating color tolerance. Diagram shown for illustrative purposes. Actual chromaticity values may vary depending on LED type and production batch.

---	Planckian Locus
○	3000K
●	3 various LED modules

Figure 2 Enlarged view of MacAdam ellipses around the 3000 K point in the CIE x,y color space. The marked points represent the measured chromaticity coordinates of three LED modules.

MacAdam Ellipses (1-, 3-, 5-, 7-step) for 3000 K – the following three points are sample chromaticity measurements for three random samples of PET midi 12 LED M930 surface white +black.

MacAdam Ellipses vs. Colour Temperature (3000K Focus)

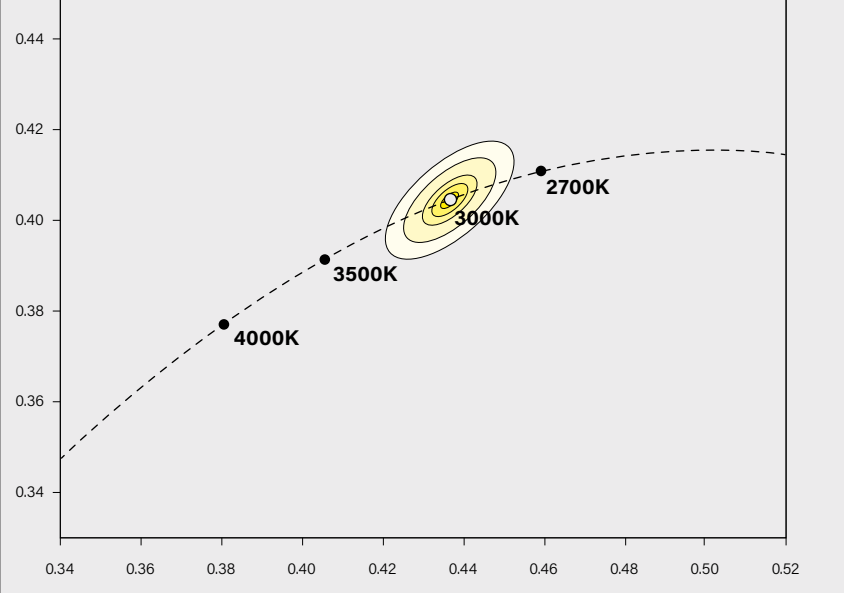

MacAdam Ellipses - 3000K (Zoom)

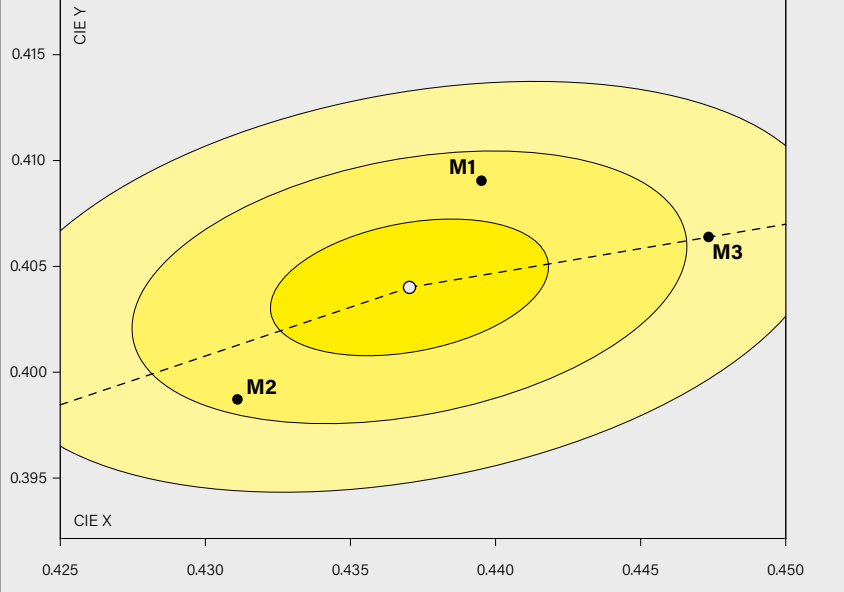

Conclusion – what influences the different dot distribution?

LED Module Binning / SDCM

Natural colour tolerances between LEDs (even within the same M930) cause subtle differences in chromaticity. Nonetheless all three samples would fit into 2nd MacAdam ellipse – not possible to detect with the naked eye, even in case of a trained observer (e.g. laboratory technician, lighting designer)

Optics and Reflector

Different reflectors modify the spectrum and angular distributions, resulting in subtle chromaticity shifts (angular colour shift). Even with the same source, different optical geometry = different colour distribution in the field.

Moreover, chromaticity is not the only parameter affecting light perception. Luminance is a major factor in how humans perceive a lighting effect. For example, three luminaires with different beam angles could all be within an SDCM tolerance of 2, yet their distinct light patterns create different final effects on an illuminated wall. Rings (Black vs. White Finish)

The black finish reduces stray light and internal reflections, reducing the impact of indirect light on the result—the dots on the SDCM diagram tend to cluster more tightly than in variants with a white ring.

Thermal Conditions and Supply Current

LED junction temperature and minor differences in current can slightly shift the chromaticity (Δx , Δy) during measurement.

Production Repeatability of Optical Elements

Differences in reflector layers (e.g., coating thickness/type, shape tolerances) also introduce small but measurable shifts.

Summary:

The three points within the 3-step (SDCM 3) show typical, catalogue-acceptable colour variation for this configuration: the light is visually consistent enough in most applications, with variations primarily due to a combination of LED tolerances (binning) and the effects of the optics/measuring environment.

Very tight requirements for SDCM are costly, but might be very important in very large or long rooms (e.g. corridors) where dozens of single luminaires or very long, continuous luminous surfaces are visible at once against a uniform background, especially when finished in white. Low SDCM is also very important in specialistic application like art, photography, colour matching or assessment.

In overwhelming majority of day to day cases SDCM 3 is sufficient both in terms of aesthetics and correct performance of visual tasks.

RISK FACTOR

The Risk Factor (RF) determines the level of risk associated with the use of LED light sources. It primarily covers photobiological safety, as well as thermal and electrical aspects that directly impact user comfort and safety.

LED light sources are designed and classified according to the IEC 62471-5:2015 standard, which defines risk groups based on optical radiation emission, particularly blue light (Blue Light Hazard).

The scope of the RF assessment includes:

- Photobiological RF – eye and skin safety
- Thermal RF – LED temperature control and durability
- Electrical RF – power supply stability and user protection

An appropriate RF level ensures safe use of LEDs in commercial, industrial, and professional applications.

Photobiological Risk Factor

The most important area of RF for LEDs is the impact of optical radiation on the human body, particularly on eyesight and skin. This assessment is performed in accordance with the IEC 62471-5:2015 standard – Photobiological Safety of Lamps and Lamp Systems. Under this standard, LED lights are classified into risk groups:



- RG0 (Risk Group 0) – no risk
- RG1 (Low Risk) – low risk
- RG2 (Moderate Risk) – moderate risk (e.g., intense LEDs)
- RG3 (High Risk) – high risk (rarely encountered in general lighting)

In case when RG class is RG2 or higher, manufacturer is obligated to include this information in technical datasheet.

The key factor here is Blue Light Hazard – the risk of retinal damage from radiation in the blue range ($\approx 400\text{--}500\text{ nm}$), especially with:

- high LED luminance,
- long exposure time,
- short viewing distance.

It is worth noting, the most hazardous source of blue light a human might encounter is the Sun that would come in Risk Group 2 or 3 (can cause injury even during very short or momentary exposure), if considered a lamp.

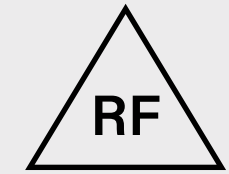

MOUNTING FRAME

WIRELESS CONTROL

Mounting frame QRLED next trimless recessed - | move

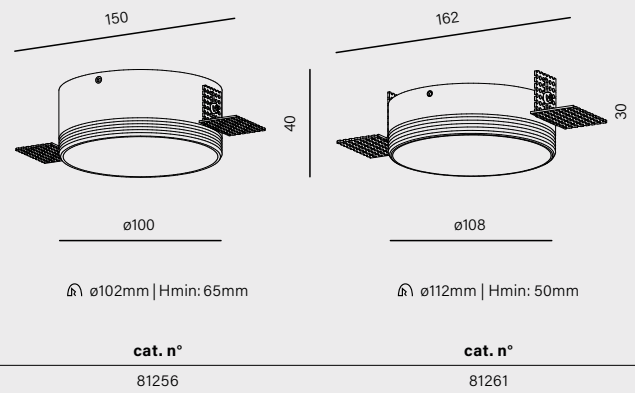

Mounting frame PUTT LED trimless recessed mini | midi | midi move | maxi

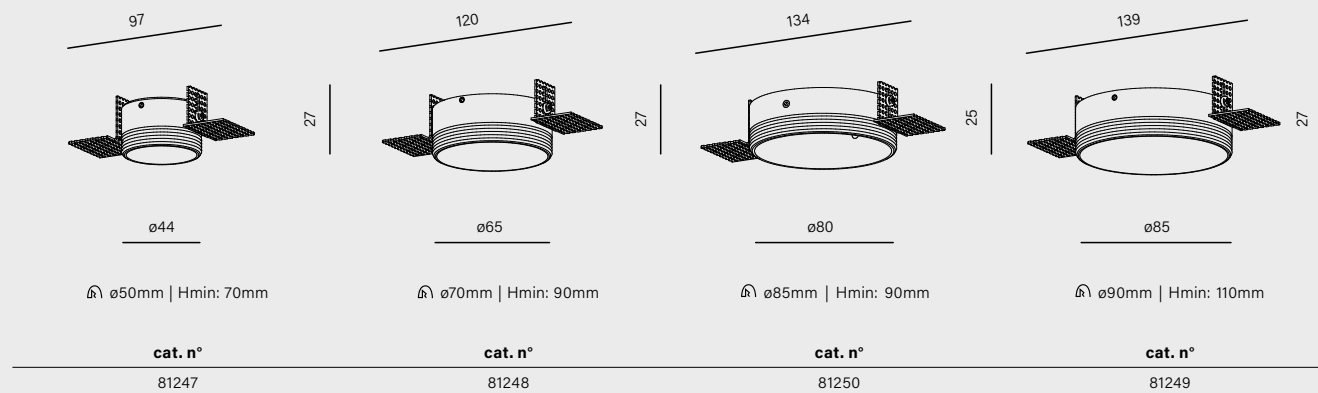

AQSMART (CASAMBI)

Casambi app, enabling you to control and manage a selection of LED luminaires via mobile devices (Apple or Android). In essence, all dimmable luminaires can be wirelessly, as long as the required components are either integrated or installed externally.

Some DALI luminaires can be wireless controlled, but requires an external component. In order to ensure the best interaction, this component needs to be installed nearby the luminaire. Installation options need to be checked according to the nature of the luminaire and the installation possibilities.

Getting Started with AQsmart (Casambi APP)

1. Download the App

- Download the Casambi app from the Apple App Store or Google Play Store on your smartphone or tablet.

2. Prepare Your Devices

- Switch on your Casambi-enabled lighting devices or luminaires.
- Make sure your phone/tablet has Bluetooth enabled.

3. Open the Casambi App

- Launch the app on your device.
- Allow any requested permissions, such as Bluetooth access and notifications.
- Accept the license agreement and privacy policy.

4. Discover Devices

- The app will automatically scan for powered Casambi devices within Bluetooth range.
- Detected devices will appear in a list under "Nearby devices" or similar.

CASAMBI COMPONENTS

5. Create a Network

- Tap on "Create a Network" to start a new lighting control network.
- You can add all detected devices at once or add devices individually.
- If adding individually, each luminaire will flash to help you identify it.
- You can rename each device and assign it to groups if desired.

6. Configure and Control

- Once devices are added to the network, you can control them from the app by turning lights on/off or adjusting brightness/color.
- Explore features such as creating scenes, schedules (timers), and sensor integration for smart controls.

7. Sharing and Permissions

- You can share network access with others by creating different passwords with permission levels like administrator or guest.

Casambi Video Tutorial

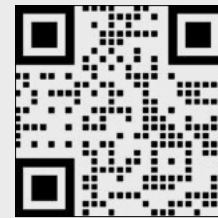

How to create a Casambi Network?

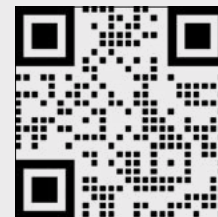

components table

Component	Code
Tridonic basicDIM G2 Casambi Bluetooth-DALI controller	81303
basicDIM Wireless Passive module G2 controller	81304
DALI power supply Tridonic DALI PS3	81305
Casambi Bluetooth-PhaseControl CBU-TED	81307
Tridonic Wireless module MTR controller	81039
AQSMT controller Entity	EN1812
Casambi Bluetooth-DALI - multitrack	SMAMUDBB

Casambi Control Devices

Casambi SOLID/MESH Remote

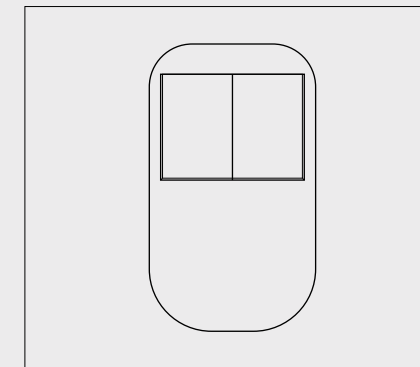

Casambi devices

AQSMT - Casambi Bluetooth-DALI controller- multitrack

max.64 DALI DEVICES | 8 Groups | plug-in to multitrack rails

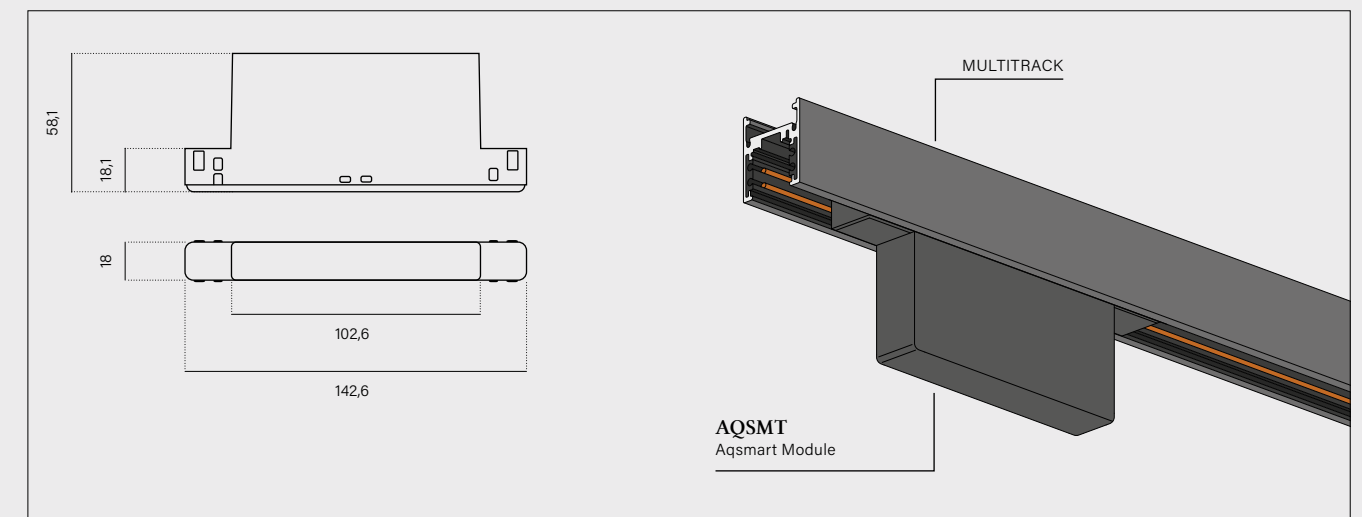

Casambi devices

Casambi Bluetooth-PhaseControl CBU-TED

IP rating — IP20

CBU-TED is a trailing-edge dimmer equipped with Bluetooth control and compatible with the Casambi system. Dimmer can be installed behind a standard wall switch, inside a light fixture, or in a ceiling outlet box.

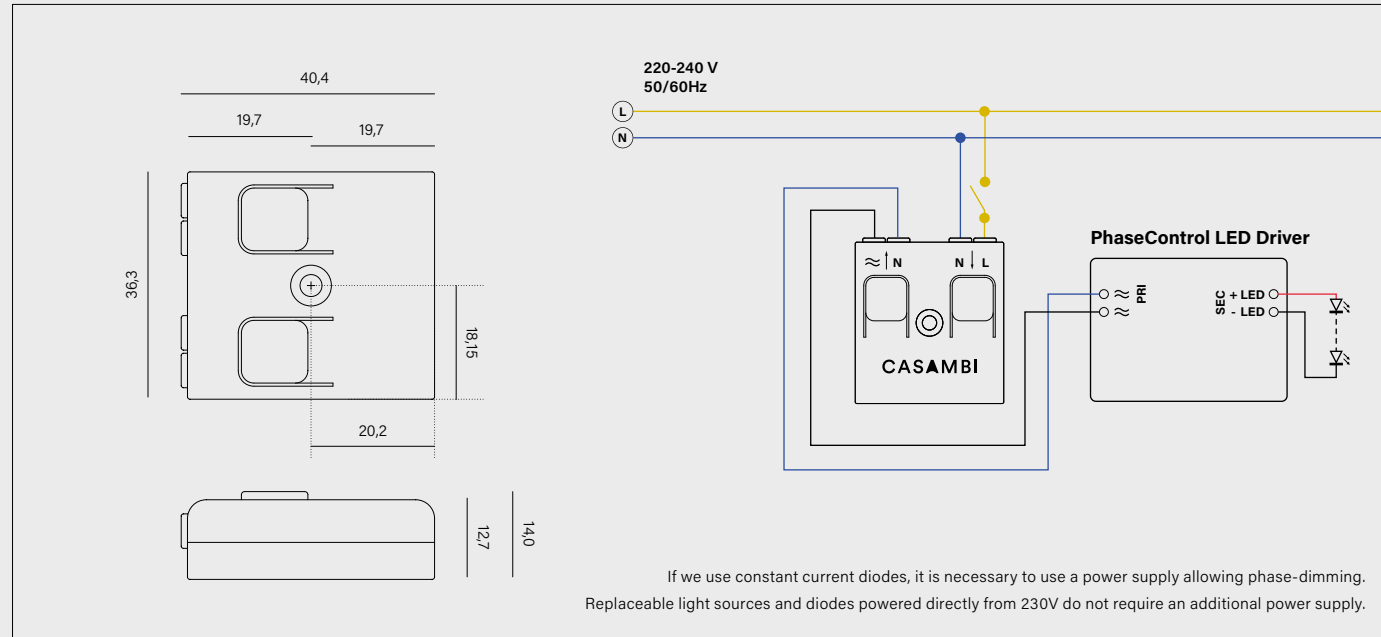

DALI power supply Tridonic DALI PS3

DALI power supply-70mA | IP rating — IP20

DALI-2 power supply unit, 70 mA output, compact design, allowing the connection of up to two units within a single DALI-2 installation. In combination with the Casambi controller, it allows connecting up to 35 luminaires.

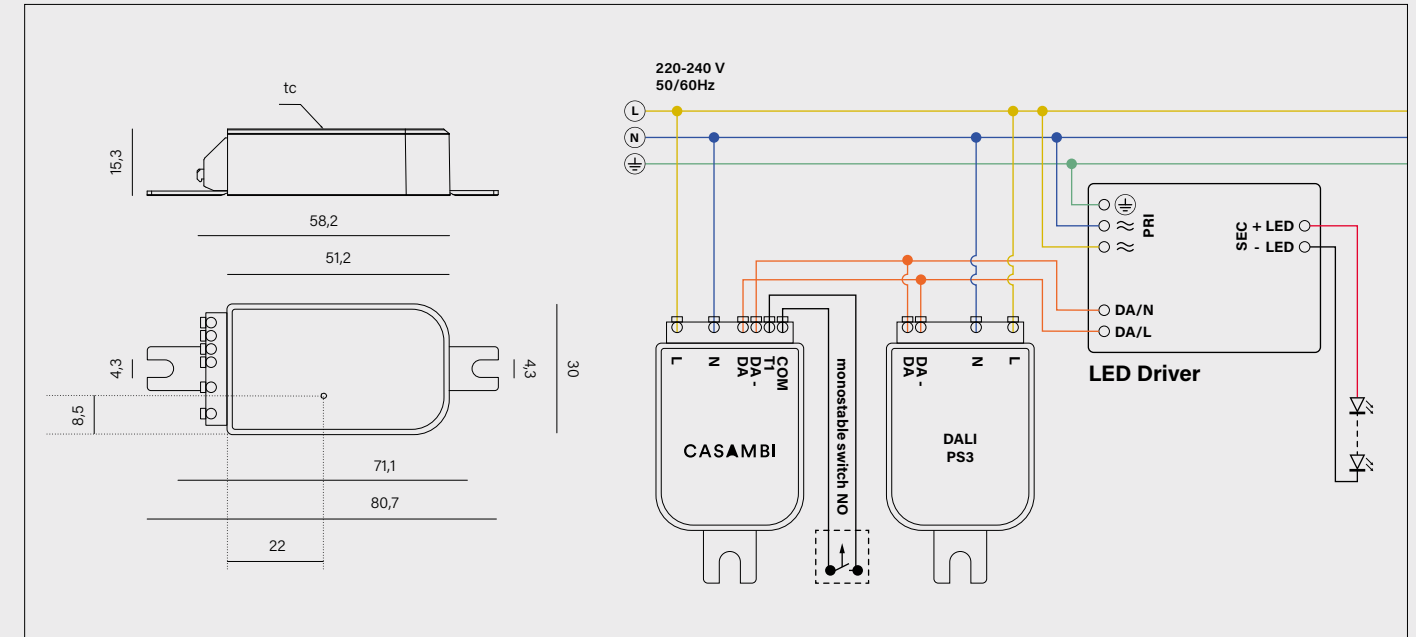

Tridonic basicDIM G2 Casambi Bluetooth-DALI controller

IP rating — IP20

Bluetooth DALI controller (CASAMBI protocol) supporting 4 individual or group DALI addresses, with a configurable push-button input, operating at DC 9.5–22.5 V.

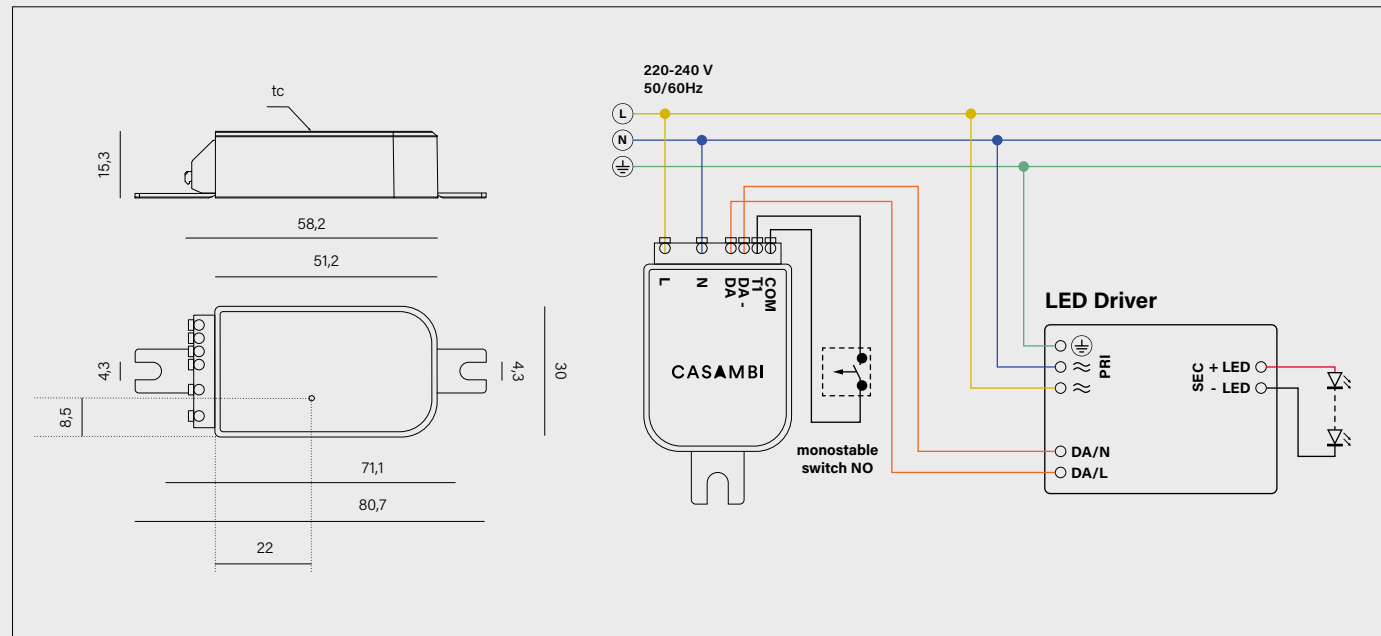

Tridonic basicDIM passive module G2

Needs external PS | IP rating — IP20

The Tridonic basicDIM Wireless Passive Module G2 is a Bluetooth controller without integrated power supply, requires PS3 for operation, and allows creation of up to 4 luminaire groups.

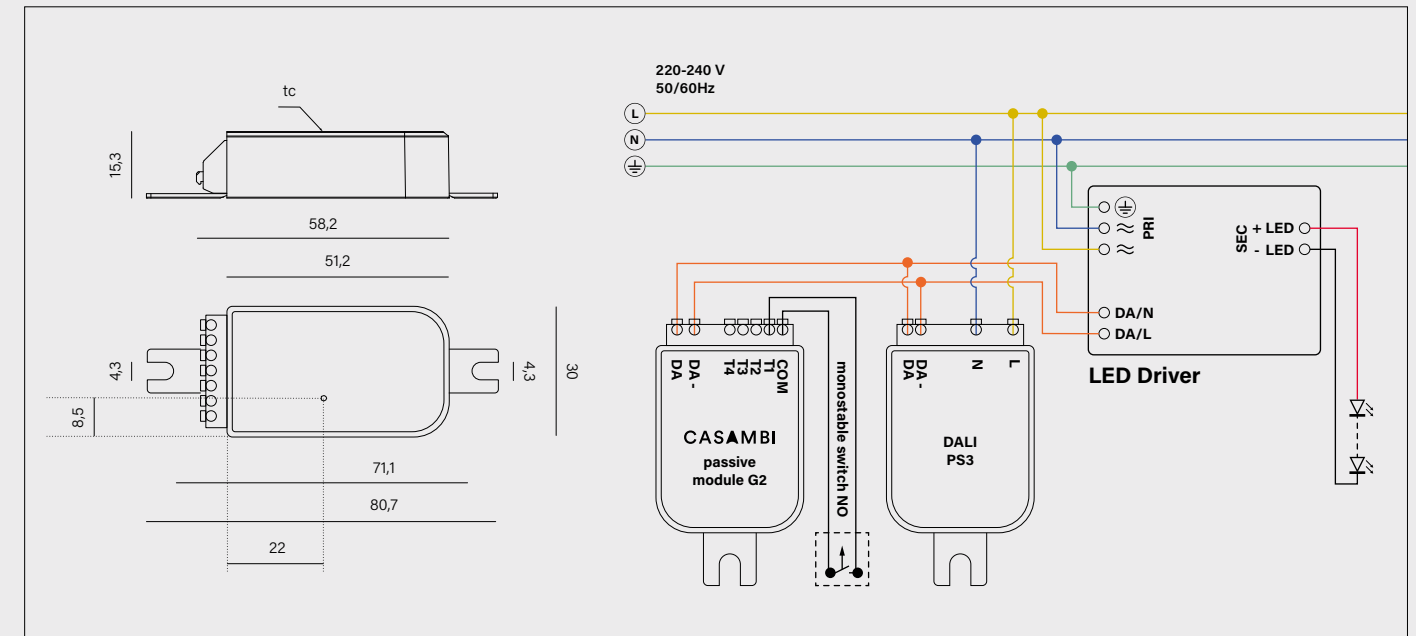

ELECTRICAL CONNECTIONS

Do's & Dont's Information about right connection

ON/OFF

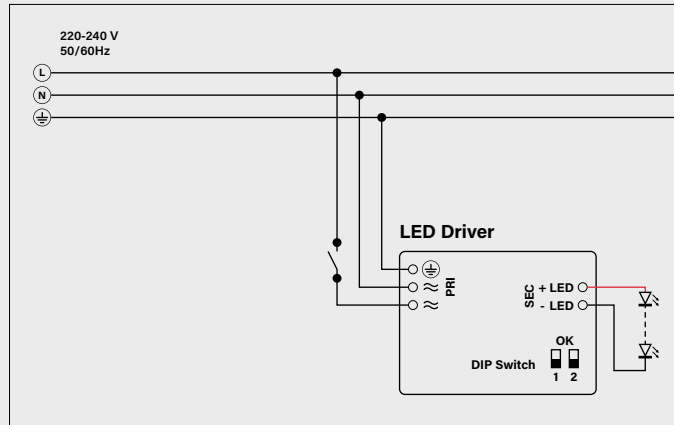

Phase Control

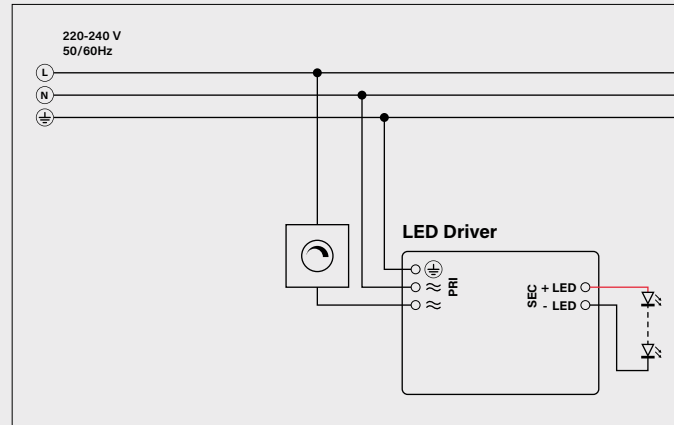

SwitchDIM

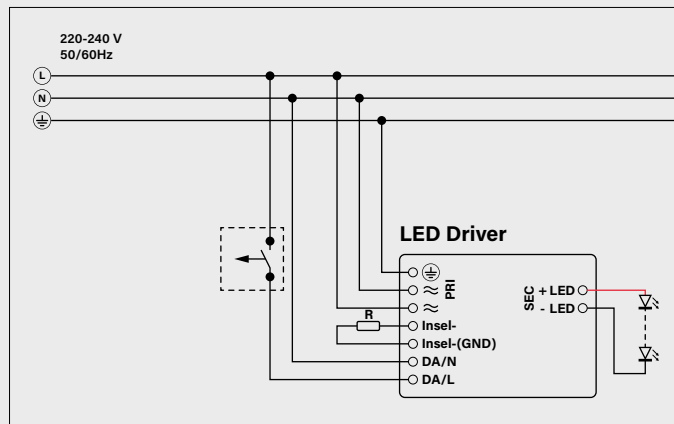

DALI

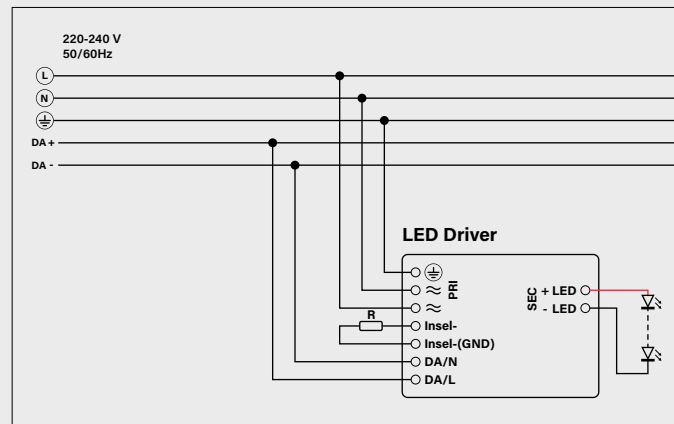

AQsmart

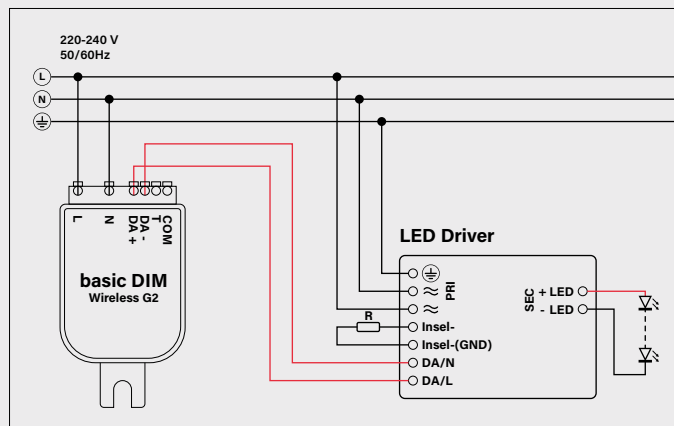

Each control system requires a power supply that allows for specific control.

DO'S

First, we connect the fixtures on the secondary side, then we connect the power supply to the fixtures on the secondary side, and finally we switch on the power.

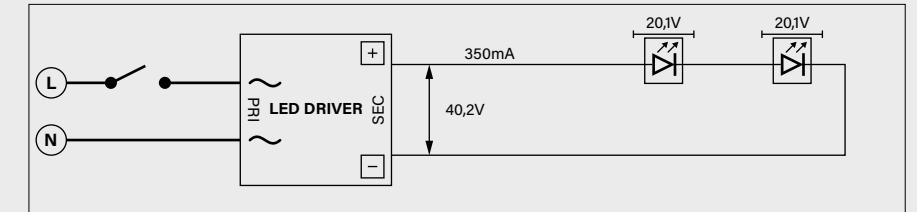

DONT'S

We do not recommend connecting the fixtures in parallel.

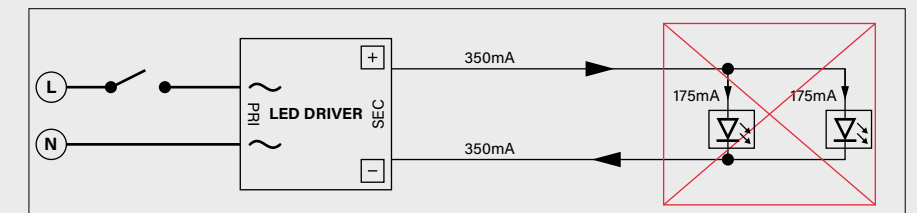

L.p.	Dimming	Product name	L x W x H [mm]	Hmin [mm]	Current [mA]	Min voltage [V]	Max voltage [V]	Power output	Input voltage	Class	IP	PF	Current setting	
ON/OFF	1	POWER SUPPLY On/Off 30W 350-725 mA 2-44V	146,5 x 43,5 x 22	49	350	10	44	15	220-240V / 50-60Hz	II	IP20	0,95	DIP-SWITCH	
					500	8	44	22	220-240V / 50-60Hz	II	IP20	0,95	DIP-SWITCH	
					700	5	44	30	220-240V / 50-60Hz	II	IP20	0,95	DIP-SWITCH	
	2	ON/OFF	POWER SUPPLY On/Off 9W 250mA 2-36V	68 x 41,6 x 22	48	250	2	36	6*/9	110*-240V / 50-60Hz	II	IP20	0,88	-
						150	10	44	6,5	220-240V / 50-60Hz	II	IP20	0,9	DIP-SWITCH
	3	ON/OFF	POWER SUPPLY On/Off 22W 125-500mA 5-44V	146,5 x 43,5 x 22	49	200	10	44	8,5	220-240V / 50-60Hz	II	IP20	0,9	DIP-SWITCH
						250	10	44	11	220-240V / 50-60Hz	II	IP20	0,9	DIP-SWITCH
						350	10	44	15	220-240V / 50-60Hz	II	IP20	0,9	DIP-SWITCH
						500	5	44	22	220-240V / 50-60Hz	II	IP20	0,9	DIP-SWITCH
						100	2,5	46	4,5	220-240V / 50-60Hz	II	IP20	0,68	DIP-SWITCH
	4	ON/OFF	POWER SUPPLY On/Off 23W 100-700mA 2,5-46V	138,4 x 30 x 21	38	150	2,5	46	6,5	220-240V / 50-60Hz	II	IP20	0,79	DIP-SWITCH
						200	2,5	46	9	220-240V / 50-60Hz	II	IP20	0,84	DIP-SWITCH
						250	2,5	46	11,5	220-240V / 50-60Hz	II	IP20	0,87	DIP-SWITCH
						350	2,5	46	16	220-240V / 50-60Hz	II	IP20	0,91	DIP-SWITCH
						500	2,5	46	23	220-240V / 50-60Hz	II	IP20	0,94	DIP-SWITCH
						600	2,5	38	22,5	220-240V / 50-60Hz	II	IP20	0,94	DIP-SWITCH
						700	2,5	33	23	220-240V / 50-60Hz	II	IP20	0,94	DIP-SWITCH
	5	ON/OFF	POWER SUPPLY On/Off 36W 150-900mA 2,5-50V	163 x 30 x 21	38	175	2,5	50	8,75	220-240V / 50-60Hz	II	IP20	0,95	NFC
						200	2,5	50	10	220-240V / 50-60Hz	II	IP20	0,95	NFC
						250	2,5	50	12,5	220-240V / 50-60Hz	II	IP20	0,95	NFC
						300	2,5	50	15	220-240V / 50-60Hz	II	IP20	0,95	NFC
						350	2,5	50	17,5	220-240V / 50-60Hz	II	IP20	0,95	NFC
						500	2,5	50	25	220-240V / 50-60Hz	II	IP20	0,95	NFC
	6	ON/OFF	POWER SUPPLY On/Off 40W 300-1050mA 5-44V	146,5 x 43,5 x 22	50	700	2,5	50	35	220-240V / 50-60Hz	II	IP20	0,95	NFC
						300	15	44	13	220-240V / 50-60Hz	II	IP20	0,95	DIP-SWITCH
						350	15	44	15	220-240V / 50-60Hz	II	IP20	0,95	DIP-SWITCH
						500	10	44	22	220-240V / 50-60Hz	II	IP20	0,95	DIP-SWITCH
						700	7	43	31	220-240V / 50-60Hz	II	IP20	0,95	DIP-SWITCH
						900	6	42	38	220-240V / 50-60Hz	II	IP20	0,95	DIP-SWITCH
7	ON/OFF	POWER SUPPLY On/Off 10W 350mA 2-30V IP68	73 x 41,5 x 24	50	350	2	30	6*/10	110*-240V / 50-60Hz	II	IP68	0,87	-	
8	ON/OFF	POWER SUPPLY On/Off 14W 500mA 2-27V	158 x 22 x 19	30	500	2	27	6*/14	110*-240V / 50-60Hz	II	IP20	0,88	-	
9	ON/OFF	POWER SUPPLY On/Off 24W 500mA 5-49V IP68	107 x 53,5 x 26	60	500	5	49	15*/24	110*-240V / 50-60Hz	II	IP68	0,97	-	
10	ON/OFF	POWER SUPPLY On/Off 7W 100-700mA 2,5-20V	65 x 28 x 18	38	250	2,5	20	5	220-240V / 50-60Hz	II	IP20	0,83	DIP-SWITCH	
					300	2,5	20	6	220-240V / 50-60Hz	II	IP20	0,84	DIP-SWITCH	
					500	2,5	13	6,5	220-240V / 50-60Hz	II	IP20	0,84	DIP-SWITCH	
					700	2,5	10	7	220-240V / 50-60Hz	II	IP20	0,85	DIP-SWITCH	
PH	11	Phase-Control	POWER SUPPLY Phase-Control 10W 250mA 14-28V	102 x 38 x 21	44	250	14	28	7	220-240V / 50-60Hz	II	IP20	0,96	-
						350	12	28	10	220-240V / 50-60Hz	II	IP20	0,96	-
						500	9	20	10	220-240V / 50-60Hz	II	IP20	0,96	-
	12	Phase-Control	POWER SUPPLY Phase-Control 10W 350mA 12-28V	102 x 38 x 21	44	250	7	44	11	220-240V / 50-60Hz	II	IP20	0,95	DIP-SWITCH
						300	7	44	13	220-240V / 50-60Hz	II	IP20	0,95	DIP-SWITCH
						350	7	44	15	220-240V / 50-60Hz	II	IP20	0,95	DIP-SWITCH
13	Phase-Control	POWER SUPPLY Phase-Control 10W 500mA 9-20V	102 x 38 x 21	44	250	7	44	11	220-240V / 50-60Hz	II	IP20	0,95	DIP-SWITCH	
					300	7	44	13	220-240V / 50-60Hz	II	IP20	0,95	DIP-SWITCH	
					350	7	44	15	220-240V / 50-60Hz	II	IP20	0,95	DIP-SWITCH	
14	Phase-Control	POWER SUPPLY Phase-Control 20W 250-900mA 7-44V	148 x 38 x 26,5	49	500	7	40	20	220-240V / 50-60Hz	II	IP20	0,95	DIP-SWITCH	
					700	7	28	20	220-240V / 50-60Hz	II	IP20	0,95	DIP-SWITCH	
					900	7	22	20	220-240V / 50-60Hz	II	IP20	0,95	DIP-SWITCH	
					250	10	49	11,5	220-240V / 50-60Hz	II	IP20	0,95	DIP-SWITCH	
					350	10	48	15,5	220-240V / 50-60Hz	II	IP20	0,95	DIP-SWITCH	
					500	10	46	21,5	220-240V / 50-60Hz	II	IP20	0,95	DIP-SWITCH	
DALI	15	DALI-2 / SWITCH	POWER SUPPLY DALI 26W 250-700 mA 10-49V	146,5 x 43,5 x 22	50	700	10	37	26	220-240V / 50-60Hz	II	IP20	0,95	DIP-SWITCH
						150	2,5	46	6,9	220-240V / 50-60Hz	II	IP20	0,85	DIP-SWITCH
						200	2,5	46	9,2	220-240V / 50-60Hz	II	IP20	0,89	DIP-SWITCH
						250	2,5	46	11,5	220-240V / 50-60Hz	II	IP20	0,91	DIP-SWITCH
	16	DALI-2 / SWITCH	POWER SUPPLY DALI 23W 100-700mA 2,5-46V	138,3 x 30 x 21	38	350	2,5	46	16,1	220-240V / 50-60Hz	II	IP20	0,94	DIP-SWITCH
						500	2,5	46	23	220-240V / 50-60Hz	II	IP20	0,96	DIP-SWITCH
						700	2,5	33	23,1	220-240V / 50-60Hz	II	IP20	0,96	DIP-SWITCH
						250	20	42	12	110-270V / 50-60Hz	II	IP20	0,95	DIP-SWITCH
	17	DALI-2	POWER SUPPLY DALI 35W 250-1000mA 8-42V	139 x 42 x 30	52	350	8	42	17	110-270V / 50-60Hz	II	IP20	0,95	DIP-SWITCH
						500	8	42	25	110-270V / 50-60Hz	II	IP20	0,95	DIP-SWITCH
						700	8	42	35	110-270V / 50-60Hz	II	IP20	0,95	DIP-SWITCH
						1000	8	35	35	110-270V / 50-60Hz	II	IP20	0,95	DIP-SWITCH
18	DALI-2 / SWITCH	POWER SUPPLY DALI 36W 150-900mA 2,5-50V	163 x 30 x 21	38	200	2,5	50	10	220-240V / 50-60Hz	II	IP20	0,95	NFC	
					250	2,5	50	12,5	220-240V / 50-60Hz	II	IP20	0,95	NFC	
					300	2,5	50	15	220-240V / 50-60Hz	II	IP20	0,95	NFC	
					350	2,5	50	17,5	220-240V / 50-60Hz	II	IP20	0,95	NFC	
					500	2,5	50	25	220-240V / 50-60Hz	II	IP20	0,95	NFC	
					700	2,5	50	35	220-240V / 50-60Hz	II	IP20	0,95	NFC	

DRIVERS CV

detailed table



	L.p.	Dimming	Code	Product name			L x W x H [mm]	Cutout [mm]	Current range	Power output	Input voltage	Class	IP	PF	Type
48V	1	ON/OFF	M0000600	MULTITRACK 48V power supply 60W			180 x 45 x 27	54	0-1.25A	60	220-240V / 50-60Hz	II	IP20	0,95	1 - linear driver
	2	ON/OFF	M00001000	MULTITRACK 48V power supply 100W			298 x 30 x 16,5	36	0-1.7*/2.1A	80*/100	120*-240V / 50-60Hz	II	IP20	0,95	1 - linear driver
	3	ON/OFF	M00002000	MULTITRACK 48V power supply 200W			384 x 30 x 22	39	0-3.1*/4.1A	150*/200	120*-240V / 50-60Hz	II	IP20	0,95	1 - linear driver
	4	ON/OFF	M00DI1200	MULTITRACK 48V DIN power supply 120W			125,2 x 113,5 x 40	-	0-2.5A	120	110-240V / 50-60Hz	-	-	-	2 - driver DIN
	5	ON/OFF	M00PI10_1	MULTITRACK 48V plug-in power supply 100W			297,5 x 16 x 19	-	0-2.1A	100	220-240V / 50-60Hz	II	IP20	0,95	3 - driver plug-in
	6	ON/OFF	M00PI25_1	MULTITRACK 48V plug-in power supply 250W			268 x 22 x 43,5	-	0-5.2A	250	220-240V / 50-60Hz	II	IP20	0,95	3 - driver plug-in

	L.p.	Dimming	Code	Product name			L x W x H [mm]	Cutout [mm]	Current range	Power output	Input voltage	Class	IP	PF	Type
24V	1	ON/OFF	81295	POWER SUPPLY 30W 24V II CLASS			246 x 30 x 16	36	0-1.25	30	220-240V / 50-60Hz	II	IP20	0,95	1 - linear driver
	2	ON/OFF	81296	POWER SUPPLY 60W 24V II CLASS			298 x 30 x 16	36	0-2.5	60	220-240V / 50-60Hz	II	IP20	0,95	1 - linear driver
	3	DALI-2	81322	POWER SUPPLY 75W 24V DALI			354 x 30 x 22	39	0-3.1	75	220-240V / 50-60Hz	II	IP20	0,95	1 - linear driver

*finish: black (12) / white (13)

POWERBOX

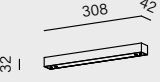
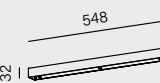
spider system

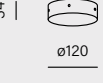
	x2 2 holes	x3 3 holes	x4 4 holes	x5 5 holes	x6 6 holes	x7 7 holes	x8 8 holes
 32 canopy bar 31x2	51000-__						
 32 canopy bar 55x2		51001-__					
 34 ø90 canopy round 9 side		50590-__					
 34 ø120 canopy round 12 side				50467-__			50466-__

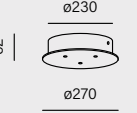
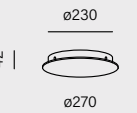
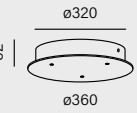
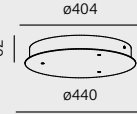
	x2 2 holes	x3 3 holes	x4 4 holes	x5 5 holes	x6 6 holes	x7 7 holes	x8 8 holes
 62 ø230 ø270 canopy round 27	51489-__	50469-__	51490-__	51491-__	51492-__	51493-__	51494-__
 42 ø230 ø270 canopy round 27 side	51483-__	51502-__	51484-__	51485-__	51586-__	51487-__	51488-__
 62 ø320 ø360 canopy round 36	51477-__	51469-__	51478-__	51479-__	51480-__	51481-__	51482-__
 42 ø320 ø360 canopy round 36 side	51495-__	51496-__	51497-__	51498-__	51499-__	51500-__	51501-__
 62 ø404 ø440 canopy round 44	51471-__	51470-__	51472-__	51473-__	51474-__	51475-__	51476-__

UGR

What do we have in mind, when we indicate UGR for a luminaire

According to UGR tables, at least in the case of certain models or configurations within the family, it is relatively easy to achieve UGR < 16. It is an indication, not a strict measure.

TRIBA mini LED suspended multitrack



UGR < 16

Co mamy na myśli, gdy podajemy UGR dla oprawy?

Zgodnie z tabelami UGR, przynajmniej w przypadku niektórych modeli lub konfiguracji w ramach rodziny, dość łatwo jest osiągnąć UGR < 16. Jest to wskazanie, a nie ścisły pomiar.

What is UGR table

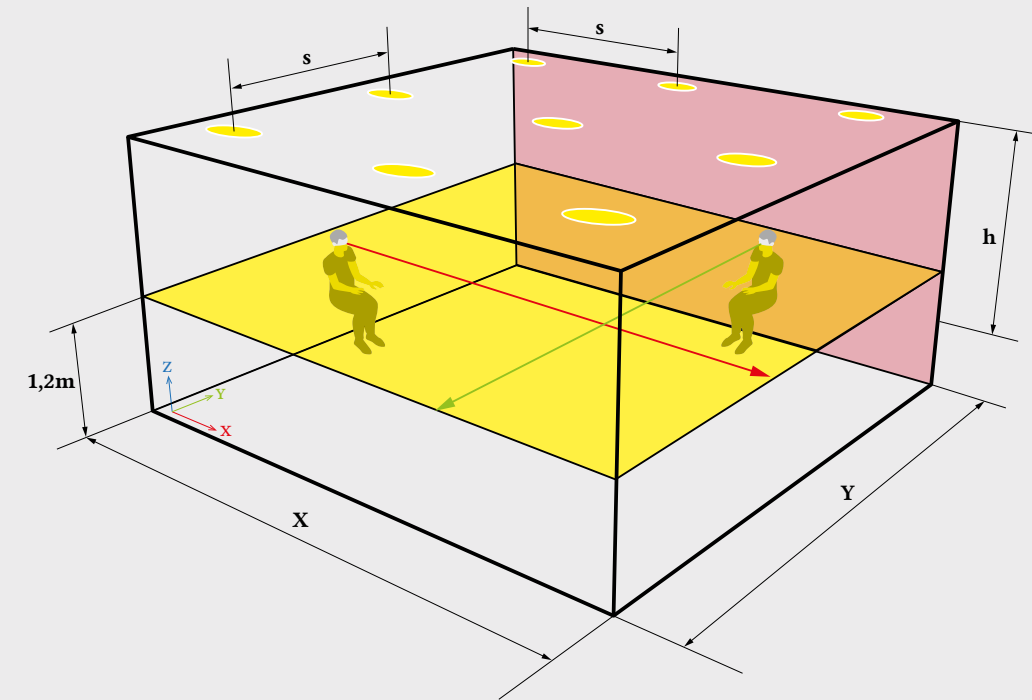

Glare evaluation according to UGR

p Ceiling	70	70	50	50	30	70	70	50	50	30	
p Walls	50	30	50	30	30	50	30	50	30	30	
p Floor	20	20	20	20	20	20	20	20	20	20	
Room size		Viewing direction at right angles					Viewing direction parallel				
X	Y										
2h	2h	6.2	6.8	6.4	7.0	7.2	6.2	6.8	6.4	7.0	7.2
2h	3h	8.2	8.8	8.5	9.1	9.3	8.2	8.8	8.5	9.1	9.3
2h	4h	9.1	9.7	9.4	9.9	10.2	9.1	9.7	9.4	9.9	10.2
2h	6h	10.4	10.9	10.7	11.2	11.5	10.4	10.9	10.7	11.2	11.5
2h	8h	10.8	11.3	11.1	11.6	11.9	10.8	11.3	11.1	11.6	11.9
2h	12h	11.4	11.9	11.8	12.2	12.5	11.4	11.9	11.8	12.2	12.5
4h	2h	6.9	7.4	7.2	7.7	7.9	6.9	7.4	7.2	7.7	7.9
4h	3h	9.2	9.7	9.6	10.0	10.3	9.2	9.7	9.6	10.0	10.3
4h	4h	10.3	10.7	10.6	11.0	11.4	10.3	10.7	10.6	11.0	11.4
4h	6h	11.8	12.1	12.2	12.5	12.9	11.8	12.1	12.2	12.5	12.9
4h	8h	12.3	12.6	12.7	13.0	13.4	12.3	12.6	12.7	13.0	13.4
4h	12h	13.0	13.3	13.4	13.7	14.1	13.0	13.3	13.4	13.7	14.1
8h	4h	10.9	11.2	11.3	11.6	12.0	10.9	11.2	11.3	11.6	12.0
8h	6h	12.5	12.8	13.0	13.2	13.6	12.5	12.8	13.0	13.2	13.6
8h	8h	13.2	13.3	13.6	13.8	14.3	13.2	13.3	13.6	13.8	14.3
8h	12h	14.1	14.2	14.6	14.7	15.2	14.1	14.2	14.6	14.7	15.2
12h	4h	11.0	11.2	11.4	11.6	12.0	11.0	11.2	11.4	11.6	12.0
12h	6h	12.7	12.9	13.1	13.3	13.8	12.7	12.9	13.1	13.3	13.8
12h	8h	13.4	13.6	13.9	14.0	14.5	13.4	13.6	13.9	14.0	14.5
Variation of the observer position for the luminaire distance S											
S = 1.0h	+0.2 / -0.2					+0.2 / -0.2					
S = 1.5h	+0.3 / -0.3					+0.3 / -0.3					
S = 2.0h	+1.0 / -0.5					+1.0 / -0.5					
Standard table	BK10					BK10					
Correction summand	-3.2					-3.2					
Corrected glare indices referring to 440 lm total luminous flux											

p Ceiling	70	70	50	50	30	70	70	50	50	30	
p Walls	50	30	50	30	30	50	30	50	30	30	
p Floor	20	20	20	20	20	20	20	20	20	20	
Room size		Viewing direction at right angles					Viewing direction parallel				
X	Y										
2h	2h	6.2	6.8	6.4	7.0	7.2	6.2	6.8	6.4	7.0	7.2
2h	3h	8.2	8.8	8.5	9.1	9.3	8.2	8.8	8.5	9.1	9.3
2h	4h	9.1	9.7	9.4	9.9	10.2	9.1	9.7	9.4	9.9	10.2
2h	6h	10.4	10.9	10.7	11.2	11.5	10.4	10.9	10.7	11.2	11.5
2h	8h	10.8	11.3	11.1	11.6	11.9	10.8	11.3	11.1	11.6	11.9
2h	12h	11.4	11.9	11.8	12.2	12.5	11.4	11.9	11.8	12.2	12.5
4h	2h	6.9	7.4	7.2	7.7	7.9	6.9	7.4	7.2	7.7	7.9
4h	3h	9.2	9.7	9.6	10.0	10.3	9.2	9.7	9.6	10.0	10.3
4h	4h	10.3	10.7	10.6	11.0	11.4	10.3	10.7	10.6	11.0	11.4
4h	6h	11.8	12.1	12.2	12.5	12.9	11.8	12.1	12.2	12.5	12.9
4h	8h	12.3	12.6	12.7	13.0	13.4	12.3	12.6	12.7	13.0	13.4
4h	12h	13.0	13.3	13.4	13.7	14.1	13.0	13.3	13.4	13.7	14.1
8h	4h	10.9	11.2	11.3	11.6	12.0	10.9	11.2	11.3	11.6	12.0
8h	6h	12.5	12.8	13.0	13.2	13.6	12.5	12.8	13.0	13.2	13.6
8h	8h	13.2	13.3	13.6	13.8	14.3	13.2	13.3	13.6	13.8	14.3
8h	12h	14.1	14.2	14.6	14.7	15.2	14.1	14.2	14.6	14.7	15.2
12h	4h	11.0	11.2	11.4	11.6	12.0	11.0	11.2	11.4	11.6	12.0
12h	6h	12.7	12.9	13.1	13.3	13.8	12.7	12.9	13.1	13.3	13.8
12h	8h	13.4	13.6	13.9	14.0	14.5	13.4	13.6	13.9	14.0	14.5
Variation of the observer position for the luminaire distance S											
S = 1.0h	+0.2 / -0.2					+0.2 / -0.2					
S = 1.5h	+0.3 / -0.3					+0.3 / -0.3					
S = 2.0h	+1.0 / -0.5					+1.0 / -0.5					
Standard table	BK10					BK10					
Correction summand	-3.2					-3.2					
Corrected glare indices referring to 440 lm total luminous flux											

UGR tables for each model and configuration are available on the website in the form of the LDT files. The table reflects UGR values calculated for a defined observer and specific room proportions.

Czym jest tabela UGR

Tabele UGR dla każdego modelu w dowolnej konfiguracji są dostępne na stronie internetowej poprzez pliki LDT. Tabela odzwierciedla wartości UGR obliczone dla określonego obserwatora i proporcji pomieszczenia.

UGR

Additional information for the pages 638 in main catalogue 2026/27:

Optics designation	Description
D9	Opal diffuser
D5	Microprismatic diffuser
S_	Spot angle (1-25)
F_	Flood angle (26-40)
W_	Wide angle > 40
D_	Diffused Light
_W	White
_B	Black
_T	Taupe
_G	Gold
PW	Plain White
_1	Reflector
_3	Lens

detailed table

family	description	optics / power	UGR _{TAB}
ALULINE	ALULINE midi	D9 (black opal cover)	18,5 - 25,4
ALULINE	ALULINE midi	D9 (white opal cover)	20,9 - 27,6
ALULINE	ALULINE mini	D9 (black opal cover)	19,1 - 26,2
ALULINE	ALULINE mini	D9 (white opal cover)	19,5 - 26,2
BIG SIZE	BIG SIZE next round PRO LED	D5 / min power (200mA)	13,8 - 19,6
BIG SIZE	BIG SIZE next round PRO LED	D5 / max power (350mA)	15,2 - 22
BIG SIZE	BIG SIZE next round LED	D9 / min power (200mA)	15,2 - 19,4
BIG SIZE	BIG SIZE next round LED	D9 / max power (350mA)	17,2 - 23,4
BLOS	BLOS round LED	D9 / L power version	18,8 - 25,4
BLOS	BLOS round LED	D9 / M power version	21,0 - 27,7
BLOS cast	BLOS cast C 33 LED surface	D9 / M power version	19,3 - 26,3
BLOS cast	BLOS cast C 40 LED surface	D9 / M power version	18,7 - 26,2
BLOS cast	BLOS cast C 55 LED surface	D9 / M power version	17,9 - 26,0
BUCCLO	BUCCLO in/down/up LED suspended	D9 / L power version	16,6 - 23,7
BUCCLO	BUCCLO in/down/up LED suspended	D9 / M power version	18,3 - 25,6
BUCCLO	BUCCLO in/down/up LED suspended	D9 / H power version	21,1 - 28,3
CONA	CONA 26 LED suspended	W1 / M power version	8,6 - 10,1
CONA	CONA 52 LED suspended	W1 / M power version	19,7 - 21,1
CONA	CONA 75 LED suspended	W1 / M power version	19,7 - 21,1
FLARED cast	FLARED cast 20 LED suspended	D9 / M power version	15,2 - 19,4

family	description	optics / power	UGR _{TAB}
FLARED cast	FLARED cast 32 LED suspended	D9 / M power version	12,4 - 13,7
FLYING BALL	FLYING BALL arc x3 LED suspended	PW / L power version	14,8 - 24,6
FLYING BALL	FLYING BALL arc x3 LED suspended	PW / M power version	15,9 - 25,7
HOLLOW	HOLLOW 6 LED recessed black	WB / M power version	14,6 - 17,3
HOLLOW	HOLLOW 6 LED recessed white	WW / M power version	13,1 - 14,9
HOLLOW	HOLLOW 8 LED recessed black	WB / M power version	7,6 - 13,8
HOLLOW	HOLLOW 8 LED recessed white	WW / M power version	13,2 - 19,2
HOLLOW	HOLLOW 8 lens LED recessed black	FB / M power version	10,9 - 13
HOLLOW	HOLLOW 8 lens LED recessed white	FW / M power version	12,2 - 16,3
KLIVA	KLIVA LED	W3	21,3 - 22,4
LEDLINE	LEDLINE soft LED	D9 / M power version	<16
LENS LINE	LENS LINE 26° LED	F3 (1 module with 5 diodes)	18,5 - 22,6
LENS LINE	LENS LINE 54° LED	W3 (1 module with 5 diodes)	20,9 - 23
MAXI POINT	MAXI POINT round LED	D9 / M power version	<16
RING dot	MAXI RING dot LED gold	DG / M power version	13,0 - 18,8
RING dot	MAXI RING dot LED white	DW / M power version	16,9 - 22,7
RING dot	MIDI RING dot LED gold	DG / M power version	12,4 - 18,1
RING dot	MIDI RING dot LED white	DW / M power version	17,3 - 23,5
MIXLINE	MIXLINE LED	D9 (1 module 28cm)	18,5 - 29,5
MODERN BALL	MODERN BALL LED	PW / L power version	14,8 - 24,6
MODERN BALL	MODERN BALL LED	PW / M power version	15,9 - 25,7
MODERN BALL simple	MODERN BALL simple maxi LED	PW / M power version	14,8 - 24,6
MODERN BALL simple	MODERN BALL simple maxi LED	PW / L power version	15,9 - 25,7
MODERN BALL simple	MODERN BALL simple midi LED	PW / L power version	14,8 - 24,6
MODERN BALL simple	MODERN BALL simple midi LED	PW / M power version	15,9 - 25,7
MODERN BALL simple	MODERN BALL simple mini LED	PW / L power version	14,8 - 24,6
MODERN BALL simple	MODERN BALL simple mini LED	PW / M power version	15,9 - 25,7
MODERN GLASS	MODERN GLASS LED	For all lampshades	14,5 - 25,8
MODERN GLASS mini	MODERN GLASS mini LED	_B	6,8 - 14,6
MODERN GLASS mini	MODERN GLASS mini LED	_W	9,4 - 17,6
MROOM	MROOM LED	D9 / M power version	<13
ONLY	ONLY round mini LED 230V exterior	D9 / M power version	24,9 - 28,4
ONLY	ONLY round mini LED 230V exterior	W3 / M power version	15,1 - 16,9
OPTIMA	OPTIMA 68° black downlight	WB / M power version / 1 module	17,3 - 18,4
PET	PET horiz 41°	W_ / M power version	5,5 - 15,5
PET	PET horiz 41°	W_ / H power version	6,7 - 16,3
PET	PET LED 230V exterior	F3 / M power version	18,8 - 23
PET	PET maxi 19° white + honeycomb	SW / L power version	12,6 - 16,2
PET	PET maxi 32° white + honeycomb	FW / L power version	13,6 - 17,3
PET	PET maxi 19° white + honeycomb	SW / M power version	13,8 - 17,4
PET	PET maxi 32° white + honeycomb	FW / M power version	14,7 - 18,4
PET	PET maxi 19° white + honeycomb	SW / H power version	14,4 - 18,0
PET	PET maxi 32° white + honeycomb	FW / H power version	15,3 - 19,0



family	description	optics / power	UGR _{TAB}
PET	PET maxi 19° LED	SB / L power version	15,2 - 17,4
PET	PET maxi 19° LED	ST / L power version	15,5 - 18,8
PET	PET maxi 19° LED	SW / L power version	16,0 - 20,5
PET	PET maxi 32° LED	FB / L power version	16,1 - 18,1
PET	PET maxi 32° LED	FT / L power version	16,2 - 18,6
PET	PET maxi 32° LED	FW / L power version	16,5 - 20,3
PET	PET maxi 19° LED	SB / M power version	16,4 - 18,6
PET	PET maxi 19° LED	ST / M power version	16,7 - 20,0
PET	PET maxi 19° LED	SW / M power version	17,1 - 21,7
PET	PET maxi 32° LED	FB / M power version	17,3 - 19,3
PET	PET maxi 32° LED	FT / M power version	17,4 - 19,4
PET	PET maxi 32° LED	FW / M power version	17,7 - 21,4
PET	PET maxi 19° LED	SB / H power version	16,4 - 18,6
PET	PET maxi 19° LED	ST / H power version	16,7 - 20,0
PET	PET maxi 19° LED	SW / H power version	17,1 - 21,7
PET	PET maxi 32° LED	FB / H power version	17,3 - 19,3
PET	PET maxi 32° LED	FT / H power version	17,4 - 19,4
PET	PET maxi 32° LED	FW / H power version	17,7 - 21,4
PET	PET midi 18° LED + honeycomb	SB	14,8 - 17,9
PET	PET midi 18° LED + honeycomb	S_	15,4 - 18,9
PET	PET midi 18° LED + honeycomb	SW	16,1 - 21,7
PET	PET midi 35° LED + honeycomb	FB	15,3 - 16,9
PET	PET midi 35° LED + honeycomb	F_	15,8 - 19,2
PET	PET midi 35° LED + honeycomb	FW	16,5 - 21,5
PET	PET midi 50° LED + honeycomb	WB	19,4 - 20,6
PET	PET midi 50° LED + honeycomb	W_	19,8 - 21,7
PET	PET midi 50° LED + honeycomb	WW	20,4 - 23,3
PET	PET midi 18° LED	SB	14,8 - 17,9
PET	PET midi 18° LED	S_	15,4 - 18,9
PET	PET midi 18° LED	SW	16,1 - 21,7
PET	PET midi 35° LED	FB	15,3 - 16,9
PET	PET midi 35° LED	F_	15,8 - 19,2
PET	PET midi 35° LED	FW	16,5 - 21,5
PET	PET midi 50° LED	WB	19,4 - 20,6
PET	PET midi 50° LED	W_	19,8 - 21,7
PET	PET midi 50° LED	WW	20,4 - 23,3
PET	PET mini 20° LED + honeycomb	SW	4,1 - 14,7

family	description	optics / power	UGR _{TAB}
PET	PET mini 41° LED + honeycomb	WW	5,5 - 15,5
PET	PET mini 20° LED	SB	7,8 - 19,4
PET	PET mini 20° LED	S_	8,9 - 20,1
PET	PET mini 20° LED	SW	8,7 - 17,8
PET	PET mini 41° LED	WB	6,8 - 15,6
PET	PET mini 41° LED	W_	7,9 - 16,3
PET	PET mini 41° LED	WW	9,4 - 17,6
PIPER	PIPER LED 230V	D9 / M power version	21,0 - 30
QRLED next	QRLED next	W3	20,7 - 21,9
RAFTER mini	RAFTER mini LED	D9	25,3 - 32,7
RAFTER mini	RAFTER mini points 24° LED	FB / M power version	11,8 - 18,2
RAFTER mini	RAFTER mini points 45° LED	WB / M power version	18,1 - 20,3
RAFTER mini	RAFTER mini points 45° LED	WW / M power version	21,8 - 27,2
RAFTER	RAFTER LED	D9	25,3 - 32,7
RAFTER points	RAFTER points 37° LED	F_ / L power version	7,9 - 11,1
RAFTER points	RAFTER points 37° LED	F_ / M power version	10,3 - 13,5
RAFTER points	RAFTER points 50° LED	W_ / L power version	11,6 - 14,0
RAFTER points	RAFTER points 50° LED	W_ / M power version	14,0 - 16,4
RIBBY	RIBBY up&down LED	D9 / L power version	14,3 - 22,4
RIBBY	RIBBY up&down LED	D9 / M power version	16,1 - 24,2
RIBBY	RIBBY up&down LED	D9 / H power version	18,7 - 26,9
RING rim	MIDI RING rim LED	D9 / M power version	24,2 - 29,5
RING rim	MINI RING rim LED	D9 / M power version	24,3 - 30
SIRCA	SIRCA 10 LED	WB / WW / M power version	22,3 - 23,9
SIRCA	SIRCA 14 LED	WB / WW / M power version	16,9 - 18,4
SIRCA	SIRCA 16 LED	WB / WW / M power version	18,1 - 19,2
SNOP	SNOP QRLED	W3	20,7 - 21,9
TRU	TRU LED	D9 / L power version	19,7 - 26
TRU	TRU LED	D9 / M power version	22,6 - 28,9
TRU	TRU PRO LED	D9 / L power version	16 - 23,1
TRU	TRU PRO LED	D9 / M power version	18,9 - 26
TRU up&down	TRU up&down LED	D9 / L power version	16,6 - 23,3
TRU up&down	TRU up&down LED	D9 / M power version	17,1 - 24
TRU up&down	TRU up&down PRO LED	D5 / L power Version	12,5 - 20,3
TRU up&down	TRU up&down PRO LED	D5 / M power version	14,1 - 21,4
VYRO 230V	VYRO LED 230V	FB / M power version	<13
VYRO 230V	VYRO LED 230V	FW / M power version	20,3 - 26,1

ALULINE COMPONENTS

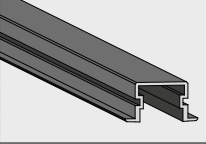
ALULINE list

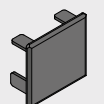
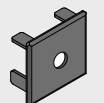
	Mastercode	Cat. n°	Product
	AL0014	81271-12	ALULINE midi profile 1m surface black
	AL0014	81271-13	ALULINE midi profile 1m surface white
	AL0014	81272-12	ALULINE midi profile 2m surface black
	AL0014	81272-13	ALULINE midi profile 2m surface white
	AL0014	81275-BO	ALULINE midi 1m diffuser black opal
	AL0014	81275-WO	ALULINE midi 1m diffuser white opal
	AL0014	81276-BO	ALULINE midi 2m diffuser black opal
	AL0014	81276-WO	ALULINE midi 2m diffuser white opal
	AL0014	81277-BO	ALULINE midi 10m diffuser black opal
	AL0014	81277-WO	ALULINE midi 10m diffuser white opal
	AL1014	81278-70	ALULINE mini profile 1m surface alu anodized
	AL1014	81278-72	ALULINE mini profile 1m surface black anodized
	AL1014	81279-70	ALULINE mini profile 2m surface alu anodized
	AL1014	81279-72	ALULINE mini profile 2m surface black anodized
	AL1014	81280-70	ALULINE mini profile 3m surface alu anodized
	AL1014	81280-72	ALULINE mini profile 3m surface black anodized
	A1001A	81283-BO	ALULINE mini 1m diffuser black opal
	A1001A	81283-WO	ALULINE mini 1m diffuser white opal
	A1001A	81284-BO	ALULINE mini 2m diffuser black opal
	A1001A	81284-WO	ALULINE mini 2m diffuser white opal
A1001A	81285-BO	ALULINE mini 3m diffuser black opal	
A1001A	81285-WO	ALULINE mini 3m diffuser white opal	
A1001A	81286-WO	ALULINE mini 10m diffuser white opal	
	AL1013	81287-70	ALULINE mini profile 1m trim recessed alu anodized
	AL1013	81287-72	ALULINE mini profile 1m trim recessed black anodized
	AL1013	81288-70	ALULINE mini profile 2m trim recessed alu anodized
	AL1013	81288-72	ALULINE mini profile 2m trim recessed black anodized
	AL1013	81289-70	ALULINE mini profile 3m trim recessed alu anodized
	AL1013	81289-72	ALULINE mini profile 3m trim recessed black anodized
	AL1713	81291-10	ALULINE mini profile 1m trimless recessed natural steel
	AL1713	81292-10	ALULINE mini profile 2m trimless recessed natural steel
	AL1713	81293-10	ALULINE mini profile 3m trimless recessed natural steel

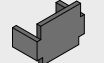
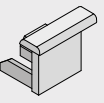
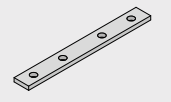
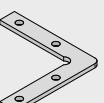
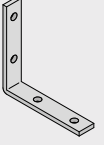
	Mastercode	Cat. n°	Product
	AL0014	81273-12	ALULINE midi end cap black
	AL0014	81273-13	ALULINE midi end cap white
	AL0014	81274-12	ALULINE midi end cap with hole black
	AL0014	81274-13	ALULINE midi end cap with hole white
	AL1014	81281-70	ALULINE mini end cap surface alu anodized
	AL1014	81281-72	ALULINE mini end cap surface black anodized
	AL1014	81282-70	ALULINE mini end cap with hole surface alu anodized
	AL1014	81282-72	ALULINE mini end cap with hole surface black anodized
	AL1013	81290-70	ALULINE mini end cap trim recessed alu anodized
	AL1013	81290-72	ALULINE mini end cap trim recessed black anodized
	AL1713	81294	ALULINE mini end cap trimless recessed natural steel
	A1001A	81266	ALULINE mechanical connector
	A1001A	81267	ALULINE mechanical "L" connector
	A1001A	81268	ALULINE mechanical wall-ceiling connector





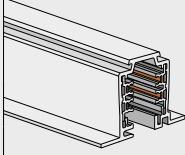
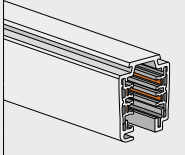
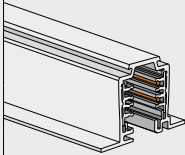
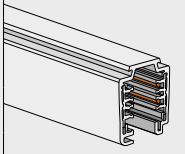

PS3000	81295	Power supply 30W 24V II class
PS3000	81296	Power supply 60W 24V II class
PS3000	81322	Power supply 75W 24V DALI

LS001A	81270-M930-00-CV-99	LED strip 5m COB (850lm/m, 10W/m 240 M930 universal
LS001A	81270-M927-00-CV-99	LED strip 5m COB (850lm/m, 10W/m 240 M927 universal
LS001A	81259-L930-00-CV-99	LED strip 5m (850lm/m, 5W/m 240 L930 universal
LS001A	81259-L927-00-CV-99	LED strip 5m (850lm/m, 5W/m 240 L927 universal
LS001A	81260-M930-00-CV-99	LED strip 5m (1200lm/m, 10W/m 240 M930 universal
LS001A	81260-M927-00-CV-99	LED strip 5m (1200lm/m, 10W/m 240 M927 universal

TRACK COMPONENTS

3F TRACK

	system	cat. n°	product	colour
	TRACK 3F 230V	TR010PH12	TRACK 3F 230V recessed 1m Phase-Control	black
	TRACK 3F 230V	TR010PH13	TRACK 3F 230V recessed 1m Phase-Control	white
	TRACK 3F 230V	TR020PH12	TRACK 3F 230V recessed 2m Phase-Control	black
	TRACK 3F 230V	TR020PH13	TRACK 3F 230V recessed 2m Phase-Control	white
	TRACK 3F 230V	TC010PH12	TRACK 3F 230V surface 1m Phase-Control	black
	TRACK 3F 230V	TC010PH13	TRACK 3F 230V surface 1m Phase-Control	white
	TRACK 3F 230V	TC020PH12	TRACK 3F 230V surface 2m Phase-Control	black
	TRACK 3F 230V	TC020PH13	TRACK 3F 230V surface 2m Phase-Control	white
	TRACK 3F 230V	TC030PH12	TRACK 3F 230V surface 3m Phase-Control	black
TRACK 3F 230V	TC030PH13	TRACK 3F 230V surface 3m Phase-Control	white	
	TRACK DALI 230V	TR010DA12	TRACK 3F 230V recessed 1m DALI	black
	TRACK DALI 230V	TR010DA13	TRACK 3F 230V recessed 1m DALI	white
	TRACK DALI 230V	TR020DA12	TRACK 3F 230V recessed 2m DALI	black
	TRACK DALI 230V	TR020DA13	TRACK 3F 230V recessed 2m DALI	white
	TRACK DALI 230V	TC010DA12	TRACK 3F 230V surface 1m DALI	black
	TRACK DALI 230V	TC010DA13	TRACK 3F 230V surface 1m DALI	white
	TRACK DALI 230V	TC020DA12	TRACK 3F 230V surface 2m DALI	black
	TRACK DALI 230V	TC020DA13	TRACK 3F 230V surface 2m DALI	white
	TRACK DALI 230V	TC030DA12	TRACK 3F 230V surface 3m DALI	black
	TRACK DALI 230V	TC030DA13	TRACK 3F 230V surface 3m DALI	white

	system	cat. n°	product	colour
	TRACK 3F 230V	TA0UNPH12	TRACK 3F 230V adapter universal Phase-Control	black
	TRACK 3F 230V	TA0UNPH13	TRACK 3F 230V adapter universal Phase-Control	white
	TRACK DALI 230V	TA0UNDA12	TRACK 3F 230V adapter universal DALI	black
	TRACK DALI 230V	TA0UNDA13	TRACK 3F 230V adapter universal DALI	white
	TRACK 3F 230V	TAPUNPH12	TRACK 3F 230V adapter power universal Phase-Control	black
	TRACK 3F 230V	TAPUNPH13	TRACK 3F 230V adapter power universal Phase-Control	white
	TRACK 3F 230V	TPCLAPH12	TRACK 3F 230V power end cap left (A) Phase-Control	black
	TRACK 3F 230V	TPCLAPH13	TRACK 3F 230V power end cap left (A) Phase-Control	white
	TRACK DALI 230V	TPCLADA12	TRACK 3F 230V power end cap left (A) DALI	black
	TRACK DALI 230V	TPCLADA13	TRACK 3F 230V power end cap left (A) DALI	white
	TRACK 3F 230V	TPCRBPH12	TRACK 3F 230V power end cap right (B) Phase-Control	black
	TRACK 3F 230V	TPCRBPH13	TRACK 3F 230V power end cap right (B) Phase-Control	white
	TRACK DALI 230V	TPCRBDA12	TRACK 3F 230V power end cap right (B) DALI	black
	TRACK DALI 230V	TPCRBDA13	TRACK 3F 230V power end cap right (B) DALI	white
	TRACK 3F 230V	TPFUNPH12	TRACK 3F 230V power flexible connector universal Phase-Control	black
	TRACK 3F 230V	TPFUNPH13	TRACK 3F 230V power flexible connector universal Phase-Control	white
	TRACK 3F 230V	TPSUNPH12	TRACK 3F 230V power connector straight universal Phase-Control	black
	TRACK 3F 230V	TPSUNPH13	TRACK 3F 230V power connector straight universal Phase-Control	white
	TRACK DALI 230V	TPSUNDA12	TRACK 3F 230V power connector straight universal DALI	black
	TRACK DALI 230V	TPSUNDA13	TRACK 3F 230V power connector straight universal DALI	white
	TRACK 3F 230V	TPLUNPH12	TRACK 3F 230V power connector "L" universal Phase-Control	black
	TRACK 3F 230V	TPLUNPH13	TRACK 3F 230V power connector „L" universal Phase-Control	white
	TRACK DALI 230V	TPLUNDA12	TRACK 3F 230V power connector "L" universal DALI	black
	TRACK DALI 230V	TPLUNDA13	TRACK 3F 230V power connector „L" universal DALI	white
	TRACK 3F 230V	TPTGAPH12	TRACK 3F 230V power connector "T" (A) Phase-Control	black
	TRACK 3F 230V	TPTGAPH13	TRACK 3F 230V power connector „T" (A) Phase-Control	white
	TRACK DALI 230V	TPTGADA12	TRACK 3F 230V power connector "T" (A) DALI	black
	TRACK DALI 230V	TPTGADA13	TRACK 3F 230V power connector „T" (A) DALI	white
	TRACK 3F 230V	TPTGBPH12	TRACK 3F 230V power connector "T" (B) Phase-Control	black
	TRACK 3F 230V	TPTGBPH13	TRACK 3F 230V power connector „T" (B) Phase-Control	white
	TRACK 3F 230V	TPTGCPH12	TRACK 3F 230V power connector "T" (C) Phase-Control	black
	TRACK 3F 230V	TPTGCPH13	TRACK 3F 230V power connector „T" (C) Phase-Control	white
	TRACK 3F 230V	TPTGDPH12	TRACK 3F 230V power connector "T" (D) Phase-Control	black
	TRACK 3F 230V	TPTGDPH13	TRACK 3F 230V power connector „T" (D) Phase-Control	white



	system	cat. n°	product	colour
	TRACK 3F 230V	TPXUNPH12	TRACK 3F 230V power connector "X" universal Phase-Control	black
	TRACK 3F 230V	TPXUNPH13	TRACK 3F 230V power connector „X" universal Phase-Control	white
	TRACK 3F 230V	TPKUNPH98	TRACK 3F 230V power internal connector universal Phase-Control	multicolour
	TRACK DALI 230V	TPKUNDA98	TRACK 3F 230V power internal connector universal DALI	multicolour
	TRACK 3F 230V	T0CUNPH12	TRACK 3F 230V end cap universal Phase-Control	black
	TRACK 3F 230V	T0CUNPH13	TRACK 3F 230V end cap universal Phase-Control	white
	TRACK DALI 230V	T0CUNDA12	TRACK 3F 230V end cap universal DALI	black
	TRACK DALI 230V	T0CUNDA13	TRACK 3F 230V end cap universal DALI	white
	TRACK 3F 230V	GSB140012	UNIVERSAL suspended box 1,4m	black
	TRACK 3F 230V	GSB140013	UNIVERSAL suspended box 1,4m	white
	TRACK 3F 230V	TCHMT0012	TRACK 3F 230V surface suspension set mounting	black
	TRACK 3F 230V	TCHMT0013	TRACK 3F 230V surface suspension set mounting	white
	TRACK 3F 230V	TWHUN0012	TRACK 3F 230V wire suspension set universal	black
	TRACK 3F 230V	TWHUN0013	TRACK 3F 230V wire suspension set universal	white
	TRACK 3F 230V	T0D000012	TRACK 3F 230V mask cover 2m	black
	TRACK 3F 230V	T0D000013	TRACK 3F 230V mask cover 2m	white
	TRACK 3F 230V	TRD000012	TRACK 3F 230V recessed mask cover	black
	TRACK 3F 230V	TRD000013	TRACK 3F 230V recessed mask cover	white

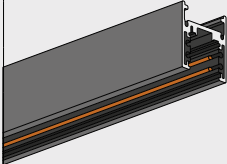



MULTITRACK

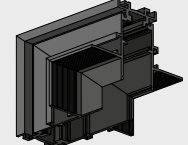
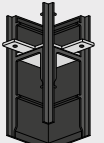
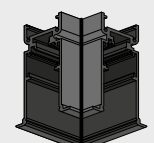

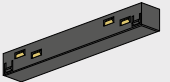
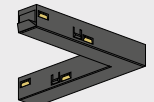
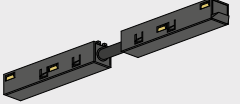
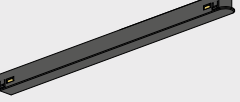
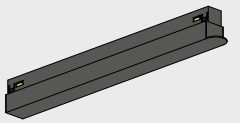
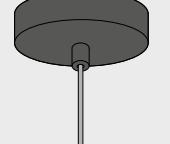

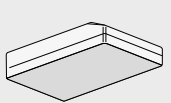
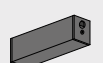
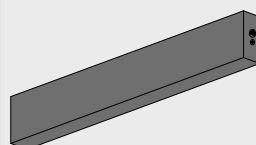
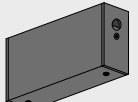
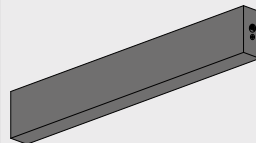
	system	cat. n°	product	colour
	MULTITRACK	M0010DA12	MULTITRACK 48V 1m DALI	black
	MULTITRACK	M0010DA13	MULTITRACK 48V 1m DALI	white
	MULTITRACK	M0010DA82	MULTITRACK 48V 1m DALI	taupe
	MULTITRACK	M0010DA83	MULTITRACK 48V 1m DALI	terracotta
	MULTITRACK	M0020DA12	MULTITRACK 48V 2m DALI	black
	MULTITRACK	M0020DA13	MULTITRACK 48V 2m DALI	white
	MULTITRACK	M0020DA82	MULTITRACK 48V 2m DALI	taupe
	MULTITRACK	M0020DA83	MULTITRACK 48V 2m DALI	terracotta
	MULTITRACK	M0030DA12	MULTITRACK 48V 3m DALI	black
	MULTITRACK	M0030DA13	MULTITRACK 48V 3m DALI	white
	MULTITRACK	M0030DA82	MULTITRACK 48V 3m DALI	taupe
	MULTITRACK	M0030DA83	MULTITRACK 48V 3m DALI	terracotta

	system	cat. n°	product	colour	
	MULTITRACK	MC010DA12	MULTITRACK 48V surface 1m DALI	black	
	MULTITRACK	MC010DA13	MULTITRACK 48V surface 1m DALI	white	
	MULTITRACK	MC010DA82	MULTITRACK 48V surface 1m DALI	taupe	
	MULTITRACK	MC010DA83	MULTITRACK 48V surface 1m DALI	terracotta	
	MULTITRACK	MC020DA12	MULTITRACK 48V surface 2m DALI	black	
	MULTITRACK	MC020DA13	MULTITRACK 48V surface 2m DALI	white	
	MULTITRACK	MC020DA82	MULTITRACK 48V surface 2m DALI	taupe	
	MULTITRACK	MC020DA83	MULTITRACK 48V surface 2m DALI	terracotta	
	MULTITRACK	MC030DA82	MULTITRACK 48V surface 3m DALI	taupe	
	MULTITRACK	MC030DA83	MULTITRACK 48V surface 3m DALI	terracotta	
		MULTITRACK	MR010DA12	MULTITRACK 48V recessed 1m DALI	black
		MULTITRACK	MR010DA13	MULTITRACK 48V recessed 1m DALI	white
MULTITRACK		MR020DA12	MULTITRACK 48V recessed 2m DALI	black	
MULTITRACK		MR020DA13	MULTITRACK 48V recessed 2m DALI	white	
	MULTITRACK	H0010DA12	MULTITRACK 48V high 1m DALI	black	
	MULTITRACK	H0010DA13	MULTITRACK 48V high 1m DALI	white	
	MULTITRACK	H0010DA82	MULTITRACK 48V high 1m DALI	taupe	
	MULTITRACK	H0010DA83	MULTITRACK 48V high 1m DALI	terracotta	
	MULTITRACK	H0020DA12	MULTITRACK 48V high 2m DALI	black	
	MULTITRACK	H0020DA13	MULTITRACK 48V high 2m DALI	white	
	MULTITRACK	H0020DA82	MULTITRACK 48V high 2m DALI	taupe	
	MULTITRACK	H0020DA83	MULTITRACK 48V high 2m DALI	terracotta	
	MULTITRACK	H0030DA12	MULTITRACK 48V high 3m DALI	black	
	MULTITRACK	H0030DA13	MULTITRACK 48V high 3m DALI	white	
	MULTITRACK	H0030DA82	MULTITRACK 48V high 3m DALI	taupe	
	MULTITRACK	H0030DA83	MULTITRACK 48V high 3m DALI	terracotta	
	MULTITRACK	HC010DA12	MULTITRACK 48V high surface 1m DALI	black	
	MULTITRACK	HC010DA13	MULTITRACK 48V high surface 1m DALI	white	
	MULTITRACK	HC010DA82	MULTITRACK 48V high surface 1m DALI	taupe	
	MULTITRACK	HC010DA83	MULTITRACK 48V high surface 1m DALI	terracotta	
	MULTITRACK	HC020DA12	MULTITRACK 48V high surface 2m DALI	black	
	MULTITRACK	HC020DA13	MULTITRACK 48V high surface 2m DALI	white	
	MULTITRACK	HC020DA82	MULTITRACK 48V high surface 2m DALI	taupe	
	MULTITRACK	HC020DA83	MULTITRACK 48V high surface 2m DALI	terracotta	
	MULTITRACK	HC030DA82	MULTITRACK 48V high surface 3m DALI	taupe	
	MULTITRACK	HC030DA83	MULTITRACK 48V high surface 3m DALI	terracotta	

	system	cat. n°	product	colour
	MULTITRACK	US010DA12	MULTITRACK 48V up&down suspended 1m DALI	black
	MULTITRACK	US020DA12	MULTITRACK 48V up&down suspended 2m DALI	black
	MULTITRACK	US030DA12	MULTITRACK 48V up&down suspended 3m DALI	black
	MULTITRACK	HR010DA12	MULTITRACK 48V high recessed 1m DALI	black
	MULTITRACK	HR010DA13	MULTITRACK 48V high recessed 1m DALI	white
	MULTITRACK	HR020DA12	MULTITRACK 48V high recessed 2m DALI	black
	MULTITRACK	HR020DA13	MULTITRACK 48V high recessed 2m DALI	white
	MULTITRACK	HR030DA12	MULTITRACK 48V high recessed 3m DALI	black
	MULTITRACK	HR030DA13	MULTITRACK 48V high recessed 3m DALI	white
	MULTITRACK	CR010DA12	MULTITRACK 48V high trim recessed 1m DALI	black
	MULTITRACK	CR010DA13	MULTITRACK 48V high trim recessed 1m DALI	white
	MULTITRACK	CR020DA12	MULTITRACK 48V high trim recessed 2m DALI	black
	MULTITRACK	CR020DA13	MULTITRACK 48V high trim recessed 2m DALI	white
	MULTITRACK	CR030DA12	MULTITRACK 48V high trim recessed 3m DALI	black
	MULTITRACK	CR030DA13	MULTITRACK 48V high trim recessed 3m DALI	white
	MULTITRACK	M00MP0011	MULTITRACK 48V mounting plate	aluminium
	MULTITRACK	M0MUN0011	MULTITRACK 48V mechanical straight connector universal	aluminium
	MULTITRACK	MSMUN0011	MULTITRACK 48V surface mechanical straight connector universal	aluminium
	MULTITRACK	M0VUN0012	MULTITRACK 48V mechanical „L“ connector universal	black
	MULTITRACK	M0VUN0013	MULTITRACK 48V mechanical „L“ connector universal	white
	MULTITRACK	M0VUN0082	MULTITRACK 48V mechanical „L“ connector universal	taupe
	MULTITRACK	M0VUN0083	MULTITRACK 48V mechanical „L“ connector universal	terracotta
	MULTITRACK	MRV000012	MULTITRACK 48V recessed mechanical „L“ connector	black
	MULTITRACK	MRV000013	MULTITRACK 48V recessed mechanical „L“ connector	white
	MULTITRACK	HCVUN0012	MULTITRACK 48V high surface mechanical „L“ connector universal	black
	MULTITRACK	HCVUN0013	MULTITRACK 48V high surface mechanical „L“ connector universal	white
	MULTITRACK	HCVUN0082	MULTITRACK 48V high surface mechanical „L“ connector universal	taupe
	MULTITRACK	HCVUN0083	MULTITRACK 48V high surface mechanical „L“ connector universal	terracotta
	MULTITRACK	HRV000012	MULTITRACK 48V high recessed mechanical „L“ connector	black
	MULTITRACK	HRV000013	MULTITRACK 48V high recessed mechanical „L“ connector	white

	system	cat. n°	product	colour
	MULTITRACK	HRWUN0012	MULTITRACK 48V high recessed mechanical wall-ceiling universal	black
	MULTITRACK	HRWUN0013	MULTITRACK 48V high recessed mechanical wall-ceiling universal	white
	MULTITRACK	USVUN0012	MULTITRACK 48V up&down suspended mechanical „L“ connector universal	black
	MULTITRACK	CRV000012	MULTITRACK 48V high trim recessed mechanical „L“ connector	black
	MULTITRACK	CRV000013	MULTITRACK 48V high trim recessed mechanical „L“ connector	white
	MULTITRACK	MPIUNDA12	MULTITRACK 48V power connector universal DALI	black
	MULTITRACK	MPIUNDA13	MULTITRACK 48V power connector universal DALI	white
	MULTITRACK	MPSUNDA12	MULTITRACK 48V power connector straight universal DALI	black
	MULTITRACK	MPSUNDA13	MULTITRACK 48V power connector straight universal DALI	white
	MULTITRACK	MPLUNDA12	MULTITRACK 48V power connector „L“ universal DALI	black
	MULTITRACK	MPLUNDA13	MULTITRACK 48V power connector „L“ universal DALI	white
	MULTITRACK	MPFUNDA12	MULTITRACK 48V power flexible connector universal DALI	black
	MULTITRACK	MPFUNDA13	MULTITRACK 48V power flexible connector universal DALI	white
	MULTITRACK	M00PI1012	MULTITRACK 48V plug-in power supply 100W	black
	MULTITRACK	M00PI1013	MULTITRACK 48V plug-in power supply 100W	white
	MULTITRACK	M00PI2512	MULTITRACK 48V plug-in power supply 250W	black
	MULTITRACK	M00PI2513	MULTITRACK 48V plug-in power supply 250W	white
	MULTITRACK	GSB140012	UNIVERSAL suspended box 1,4m	black
	MULTITRACK	GSB140013	UNIVERSAL suspended box 1,4m	white
	MULTITRACK	GSB140082	UNIVERSAL suspended box 1,4m	taupe
	MULTITRACK	GSB140083	UNIVERSAL suspended box 1,4m	terracotta

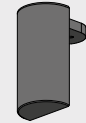
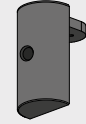

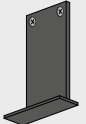
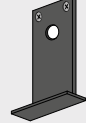
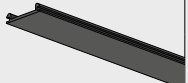
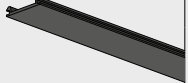

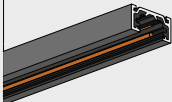
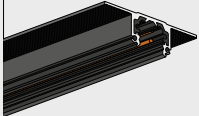
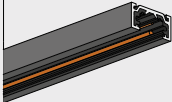

	system	cat. n°	product	colour
	MULTITRACK	M0000600	MULTITRACK 48V power supply 60W	
	MULTITRACK	M00001000	MULTITRACK 48V power supply 100W	
	MULTITRACK	M00002000	MULTITRACK 48V power supply 200W	
	MULTITRACK	M00DI1200	MULTITRACK 48V DIN power supply 120W	
	MULTITRACK	MCB010012	MULTITRACK 48V surface box 0,1m	black
	MULTITRACK	MCB010013	MULTITRACK 48V surface box 0,1m	white
	MULTITRACK	MCB010082	MULTITRACK 48V surface box 0,1m	taupe
	MULTITRACK	MCB010083	MULTITRACK 48V surface box 0,1m	terracotta
	MULTITRACK	M0B001012	MULTITRACK 48V box power supply 100W	black
	MULTITRACK	M0B001013	MULTITRACK 48V box power supply 100W	white
	MULTITRACK	M0B001082	MULTITRACK 48V box power supply 100W	taupe
	MULTITRACK	M0B001083	MULTITRACK 48V box power supply 100W	terracotta
	MULTITRACK	HCB010012	MULTITRACK 48V high surface box 0,1m	black
	MULTITRACK	HCB010013	MULTITRACK 48V high surface box 0,1m	white
	MULTITRACK	HCB010082	MULTITRACK 48V high surface box 0,1m	taupe
	MULTITRACK	HCB010083	MULTITRACK 48V high surface box 0,1m	terracotta
	MULTITRACK	H0B001012	MULTITRACK 48V high box power supply 100W	black
	MULTITRACK	H0B001013	MULTITRACK 48V high box power supply 100W	white
	MULTITRACK	H0B001082	MULTITRACK 48V high box power supply 100W	taupe
	MULTITRACK	H0B001083	MULTITRACK 48V high box power supply 100W	terracotta
	MULTITRACK	M0C000012	MULTITRACK 48V end cap	black
	MULTITRACK	M0C000013	MULTITRACK 48V end cap	white
	MULTITRACK	M0C000082	MULTITRACK 48V end cap	taupe
	MULTITRACK	M0C000083	MULTITRACK 48V end cap	terracotta
	MULTITRACK	M0CHL0012	MULTITRACK 48V end cap with hole	black
	MULTITRACK	M0CHL0013	MULTITRACK 48V end cap with hole	white
	MULTITRACK	M0CHL0082	MULTITRACK 48V end cap with hole	taupe
	MULTITRACK	M0CHL0083	MULTITRACK 48V end cap with hole	terracotta
	MULTITRACK	M0Z000012	MULTITRACK 48V end cap rounded	black
	MULTITRACK	M0Z000013	MULTITRACK 48V end cap rounded	white
	MULTITRACK	M0Z000082	MULTITRACK 48V end cap rounded	taupe
	MULTITRACK	M0Z000083	MULTITRACK 48V end cap rounded	terracotta
	MULTITRACK	M0ZHL0012	MULTITRACK 48V end cap rounded with hole	black
	MULTITRACK	M0ZHL0013	MULTITRACK 48V end cap rounded with hole	white
	MULTITRACK	M0ZHL0082	MULTITRACK 48V end cap rounded with hole	taupe
	MULTITRACK	M0ZHL0083	MULTITRACK 48V end cap rounded with hole	terracotta

	system	cat. n°	product	colour
	MULTITRACK	MRC000012	MULTITRACK 48V recessed end cap	black
	MULTITRACK	MRC000013	MULTITRACK 48V recessed end cap	white
	MULTITRACK	H0CUN0012	MULTITRACK 48V high end cap universal	black
	MULTITRACK	H0CUN0013	MULTITRACK 48V high end cap universal	white
	MULTITRACK	H0CUN0082	MULTITRACK 48V high end cap universal	taupe
	MULTITRACK	H0CUN0083	MULTITRACK 48V high end cap universal	terracotta
	MULTITRACK	H0CHL0012	MULTITRACK 48V high end cap with hole	black
	MULTITRACK	H0CHL0013	MULTITRACK 48V high end cap with hole	white
	MULTITRACK	H0CHL0082	MULTITRACK 48V high end cap with hole	taupe
	MULTITRACK	H0CHL0083	MULTITRACK 48V high end cap with hole	terracotta
	MULTITRACK	H0Z000012	MULTITRACK 48V high end cap rounded	black
	MULTITRACK	H0Z000013	MULTITRACK 48V high end cap rounded	white
	MULTITRACK	H0Z000082	MULTITRACK 48V high end cap rounded	taupe
	MULTITRACK	H0Z000083	MULTITRACK 48V high end cap rounded	terracotta
	MULTITRACK	H0ZHL0012	MULTITRACK 48V high end cap rounded with hole	black
	MULTITRACK	H0ZHL0013	MULTITRACK 48V high end cap rounded with hole	white
	MULTITRACK	H0ZHL0082	MULTITRACK 48V high end cap rounded with hole	taupe
	MULTITRACK	H0ZHL0083	MULTITRACK 48V high end cap rounded with hole	terracotta
	MULTITRACK	U0CUN0012	MULTITRACK 48V up&down end cap	black
	MULTITRACK	C0C000012	MULTITRACK 48V high trim end cap	black
	MULTITRACK	C0C000013	MULTITRACK 48V high trim end cap	white
	MULTITRACK	C0CHL0012	MULTITRACK 48V high trim end cap with hole	black
	MULTITRACK	C0CHL0013	MULTITRACK 48V high trim end cap with hole	white
	MULTITRACK	M0D300012	MULTITRACK 48V mask cover 3m	black
	MULTITRACK	M0D300013	MULTITRACK 48V mask cover 3m	white
	MULTITRACK	HRN200012	MULTITRACK 48V high recessed mask cover 3m	black
	MULTITRACK	HRN200013	MULTITRACK 48V high recessed mask cover 3m	white

	system	cat. n°	product	colour
	MULTITRACK	MSH140000	MULTITRACK 48V suspended suspension set 1,4m	
	MULTITRACK	MRE000011	MULTITRACK 48V recessed mounting foot set	aluminium
	MULTITRACK	CRE000011	MULTITRACK 48V high trim recessed mounting foot set	aluminium
	MULTITRACK	HRQ000000	MULTITRACK 48V high recessed mounting template	
	MULTITRACK	HRD300012	MULTITRACK 48V high recessed mounting cover 2m	black
	MULTITRACK	UW0000012	MULTITRACK 48V up&down wire	black
	MULTITRACK	MWA000000	MULTITRACK 48V wire crimping accessory	
	MULTITRACK	M00PIAS12	MULTITRACK 48V plug-in Aqsmart	black
	MULTITRACK	M00PIAS13	MULTITRACK 48V plug-in Aqsmart	white

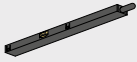
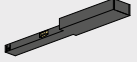
MICROTRACK

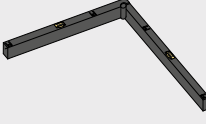
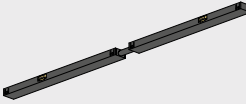
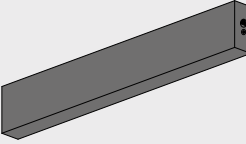
	system	cat. n°	product	colour
	MICROTRACK	OC010DA12	MICROTRACK 48V surface 1m DALI	black
	MICROTRACK	OC020DA12	MICROTRACK 48V surface 2m DALI	black
	MICROTRACK	OR010DA12	MICROTRACK 48V recessed 1m DALI	black
	MICROTRACK	OR020DA12	MICROTRACK 48V recessed 2m DALI	black
	MICROTRACK	OCRR3DA12	MICROTRACK 48V surface round connector radius 0,3 DALI	black
	MICROTRACK	OCRR5DA12	MICROTRACK 48V surface round connector radius 0,5 DALI	black

	system	cat. n°	product	colour
	MICROTRACK	OCVUN0012	MICROTRACK 48V surface mechanical "L" connector	black
	MICROTRACK	OXJUN0012	MICROTRACK 48V wall ceiling mechanical connector	black
	MICROTRACK	OPC25DA12	MICROTRACK 48V power end cap 2,5m DALI black	black
	MICROTRACK	OPC00DA12	MICROTRACK 48V power end cap DALI black	black
	MICROTRACK	OPSUNDA12	MICROTRACK 48V power connector straight universal DALI	black
	MICROTRACK	OPLUN0012	MICROTRACK 48V power connector "L" universal	black
	MICROTRACK	OXIUNDA12	MICROTRACK 48V wall ceiling connector universal DALI	black
	MICROTRACK	O0FUNDA12	MICROTRACK 48V flexible connector universal DALI	black
	MICROTRACK	M0B001012	MICROTRACK 48V power box power supply 100W	black
	MICROTRACK	O0CUN0012	MICROTRACK 48V end cap	black
	MICROTRACK	ORCUN0012	MICROTRACK 48V recessed end cap	black

page 003:

SNOP E27 surface



CONA LED 26 suspended

contents

RECESSED	054
SURFACE	124
SUSPENDED	228
TRACK	342
WALL	452
FLOOR, TABLE, PORTABLE	504
EXTERIOR	522
SYSTEMS	562
INDEX by name	630

All dimensions and technical data in catalogues are provided for a guidance purposes only. Actual data may differ slightly due to the production process. Technical information contained within Aquaform's website, data sheets or mounting instructions shall prevail over the information contained in catalogues. Aquaform Inc. reserves the right to change the presented materials and product specifications without prior notice.

Aquaform Inc. takes no responsibility for any possible misprints. All photos, icons and images are copyright protected. Images are illustrative presentations of products and colours. Due to the production process RAL colour of white track and adapter differs a few tones from a standard white finish of AQForm luminaires.

Information contained in the catalogue shall not constitute an offer, also within the meaning of art. 66 § 1 of Polish Civil Code.

© 2026 AQUAFORM Inc. sp. z o.o.
All rights reserved.

Podane w katalogach wymiary oraz informacje techniczne mają jedynie charakter informacyjny. Rzeczywiste dane mogą się nieznacznie różnić ze względu na proces produkcyjny. Informacje techniczne zawarte na stronie www, w kartach katalogowych oraz w instrukcjach montażu mają pierwszeństwo przed informacjami z katalogów. Aquaform Inc. zastrzega sobie prawo do zmiany przedstawianych materiałów i parametrów technicznych produktów bez wcześniejszego powiadomienia.

Aquaform Inc. nie ponosi odpowiedzialności za możliwe błędy w druku. Zdjęcia są chronione prawnie. Na zdjęciach pokazane jest poglądowe przedstawienie produktów oraz kolorów. Ze względu na proces produkcyjny kolor RAL biały szynoprzewodów oraz adapterów różni się o kilka tonów od standardowego białego wykończenia opraw AQForm.

Informacje zawarte w katalogu nie stanowią oferty handlowej, w tym w rozumieniu art. 66 §1 Kodeksu Cywilnego.

© 2026 AQUAFORM Inc. sp. z o.o.
Wszelkie prawa zastrzeżone.

PART OF
DELTALIGHT
Group

Icons and cat. n° legend

protection class / klasa ochronności



ingress protection rating (...) / klasa szczelności oprawy (...)

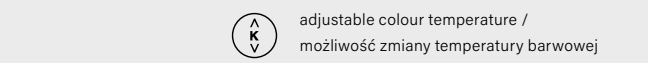
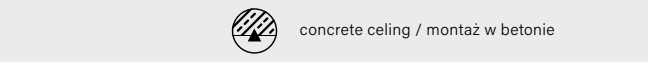
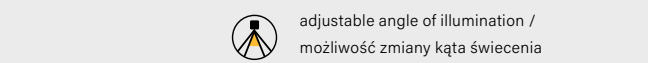
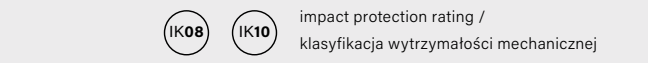
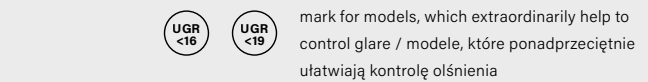
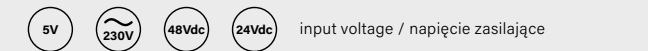
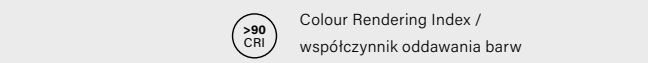
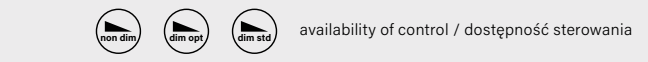
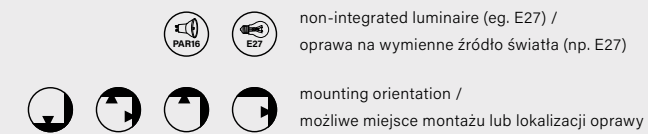

The catalogue number format contains information on the key technical parameters of the luminaire. Information shown in black refers to fixed (unchangeable) luminaire parameters. Information shown in green (-__30-) refers to optional (changeable) luminaire parameters.

Format numeru katalogowego zawiera informacje o najważniejszych parametrach technicznych oprawy oświetleniowej. Informacje opisane czarnymi znakami dotyczą stałych (niezmiennych) parametrów oprawy. Informacje opisane zielonymi znakami (-__30-) dotyczą opcjonalnych (zmiennych) parametrów oprawy.

luminaire version optics

12345-M930-F1-PH-13

power
low (-L__-)
medium (-M__-)
high (-H__-)
adjustable (-A__-)
E27 (-E__-)
GU10 (-G__-)

CRI
CRI>90 (-_9__-)
n/a (-_0__-)

CCT
2700K (-__27-)
3000K (-__30-)
4000K (-__40-)
2700-6500K (-M962-) – DALI or AQsmart required
2700K, 3000K, 4000K (-M942-)
n/a (-__00-)

beam angle | light distribution
1-25° – spot (-S_-)
26-40° – flood (-F_-)
>40° – wide (-W_-)
zoom (-Z_-) | diffused (-D_-) | untypical (-Y_-)
n/a (-0_-)

optics finish | material
black (-_B-) reflector (-_1-) | lens (-_3-) | cover (-_9-)
white (-_W-) microprism (-_5-) | another (-_6-) | n/a (-_0-)

dimming | control
ON/OFF (-00-) non dim switchDIM (-SW-) occupation sensor (-OS-)
Phase-Control (-PH-) AQsmart (-DB-) constant voltage (-CV-)
DALI (-DA-) require driver (-CC-) second circuit (-01-)
touchDIM (-TD-) motion sensor (-MS-) 2 circuits (-02-)

finish *more finishes available

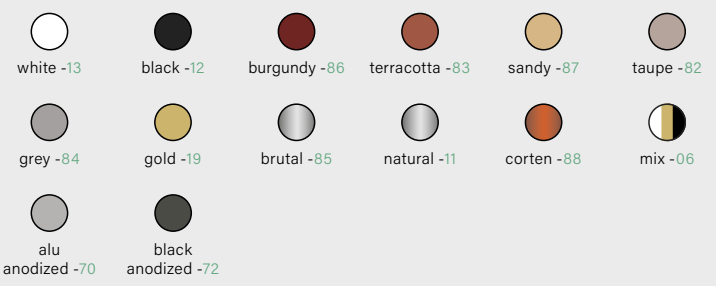

About mix colours:
- 06 - this finish allows to mix all AQForm colours - including gold, grey, burgundy, terracotta, sandy, taupe
mixes for some products

26 / 27

aqform.com